

# PROPOSED INDUSTRIAL FACILITY

Oakdale Central Lot 3A,  
HORSLEY PARK, NSW  
LANDSCAPE TENDER

## DRAWINGS

DWG NO.	DRAWING TITLE	SCALE
000	COVERSHEET	N/A
101	LANDSCAPE PLAN	1:200
102	LANDSCAPE PLAN	1:200
501	LANDSCAPE DETAILS	AS SHOWN

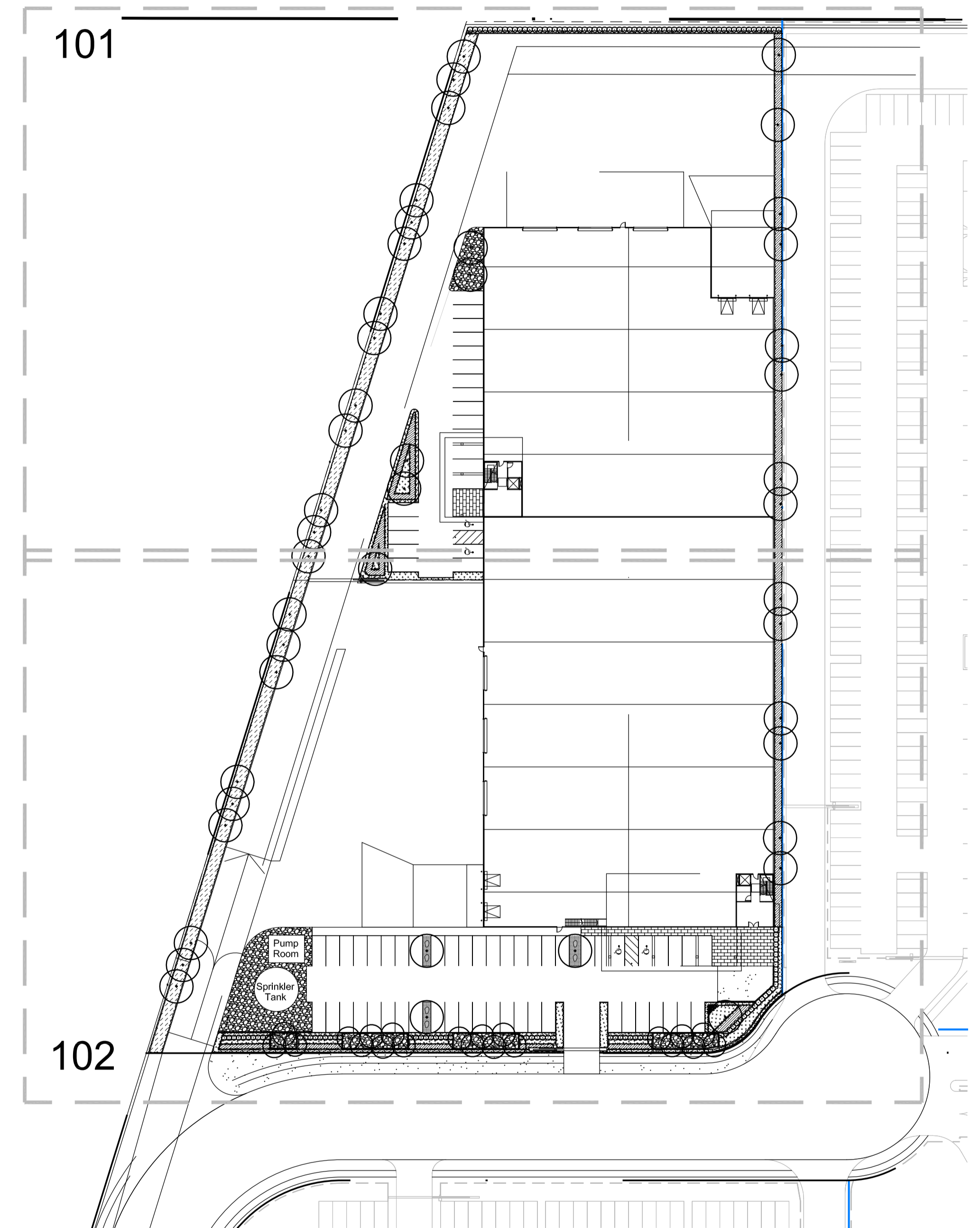

NOT FOR CONSTRUCTION

© 2014 Site Image (NSW) Pty Ltd ABN 44 801 262 380 as agent for Site Image NSW Partnership. All rights reserved. This drawing is copyright and shall not be reproduced or copied in any form or by any means (graphic, electronic or mechanical including photocopy) without the written permission of Site Image (NSW) Pty Ltd. Any license, expressed or implied, to use this document for any purpose what so ever is restricted to the terms of the written agreement between Site Image (NSW) Pty Ltd and the instructing party.

The contractor shall check and verify all work on site (including work by others) before commencing the landscape installation. Any discrepancies are to be reported to the Project Manager or Landscape Architect prior to commencing work. Do not scale this drawing. Any required dimensions not shown shall be referred to the Landscape Architect for confirmation.

Issue	Revision Description	Drawn	Check	Date
B	Plant Species Adjusted	JW	NM	02.06.2016
A	For Comment	JW	NM	24.05.2016

## LEGEND

Key Plan:

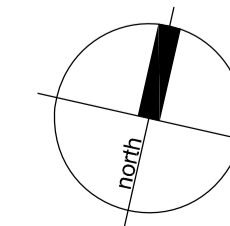

SITE IMAGE



Landscape Architects  
Level 1, 3-5 Baptist Street  
Redfern NSW 2016  
Australia  
Tel: (61 2) 8332 5600  
Fax: (61 2) 9698 2877  
www.siteimage.com.au

Client:

Goodman

Project:

Proposed Industrial Facility  
Oakdale Central Lot 3A  
Horsley Park, NSW

Drawing Name:

Coversheet

Scale:

SS13-2656

TENDER

Job Number:

Drawing Number:

Issue:

000 B







**NOT FOR CONSTRUCTION**

© 2014 Site Image (NSW) Pty Ltd ABN 44 801 262 380 as agent for Site Image NSW Partnership. All rights reserved. This drawing is copyright and shall not be reproduced or copied in any form or by any means (graphic, electronic or mechanical including photocopy) without the written permission of Site Image (NSW) Pty Ltd Any license, expressed or implied, to use this document for any purpose what so ever is restricted to the terms of the written agreement between Site Image (NSW) Pty Ltd and the instructing party.

The contractor shall check and verify all work on site (including work by others) before commencing the landscape installation. Any discrepancies are to be reported to the Project Manager or Landscape Architect prior to commencing work. Do not scale this drawing. Any required dimensions not shown shall be referred to the Landscape Architect for confirmation.

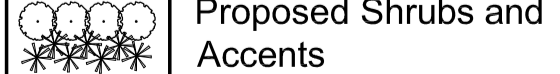
Issue	Revision Description	Drawn	Check	Date
B	Plant Species Adjusted	JW	NM	02.06.2016
A	For Comment	JW	NM	24.05.2016

**LEGEND**

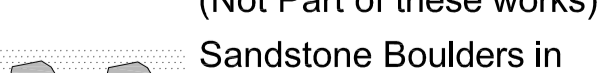
-  Property Boundary
-  Proposed Trees
-  Proposed Grasses and Groundcovers
-  Proposed Shrubs and Accents
-  Turf
-  Feature Rock Ballast
-  'Kwik Kerb' Concrete Edge refer specification (Not Part of these works)
-  Sandstone Boulders in Decomposed Granite

Key Plan:

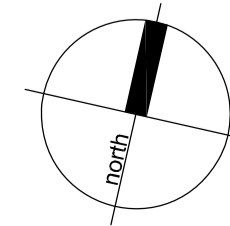

Continues DWG 102

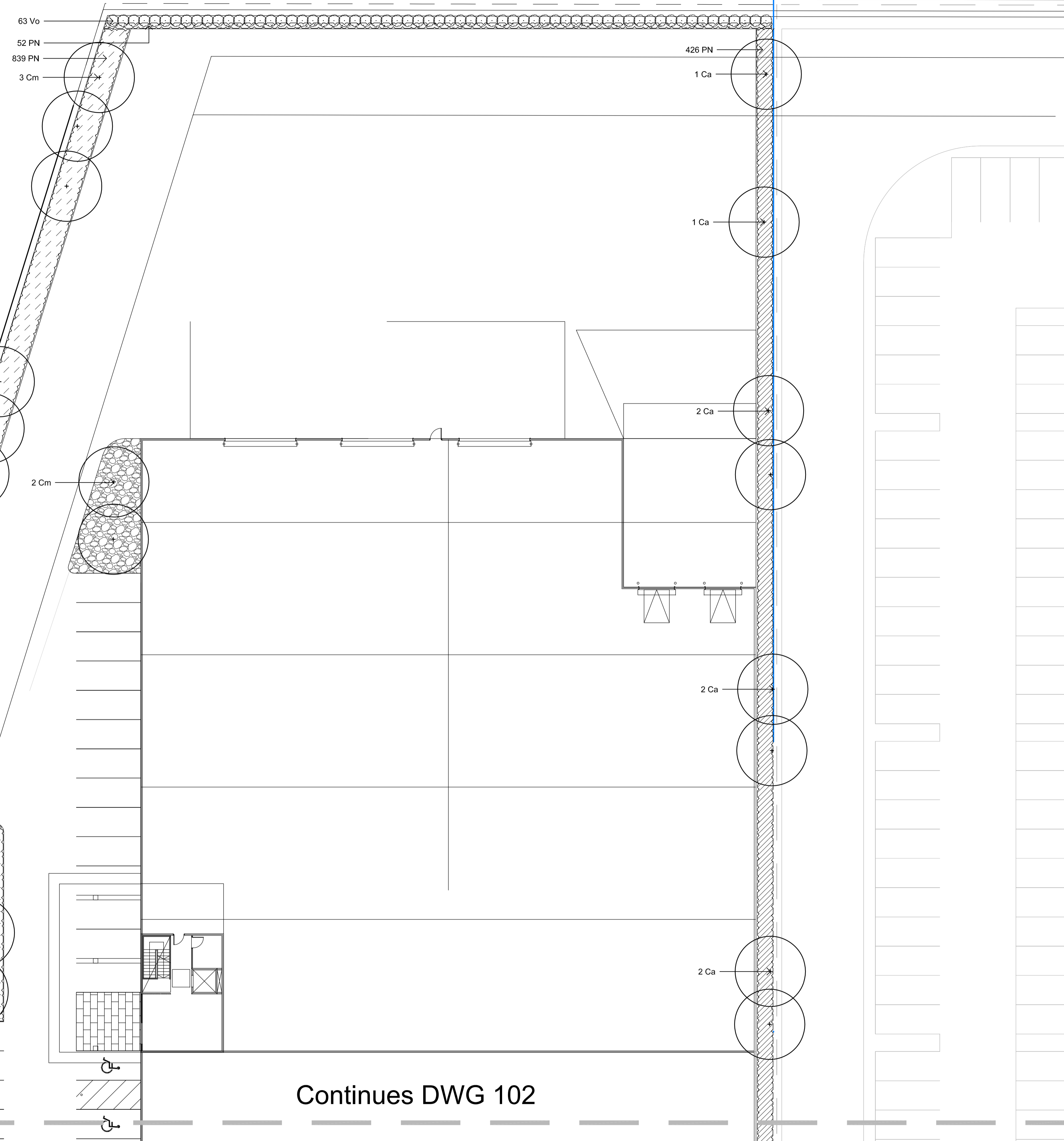

SITE IMAGE



Landscape Architects  
Level 1, 3-5 Baptist Street  
Redfern NSW 2016  
Australia  
Tel: (61 2) 8332 5600  
Fax: (61 2) 9698 2877  
www.siteimage.com.au

Client:

Goodman

Project:

Proposed Industrial Facility  
Oakdale Central Lot 3A  
Horsley Park, NSW

Drawing Name:

Landscape Plan

Scale: 1:200 @ A1

Job Number:

SS13-2656

TENDER

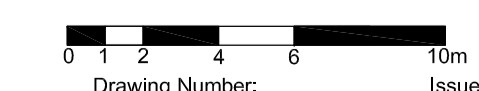

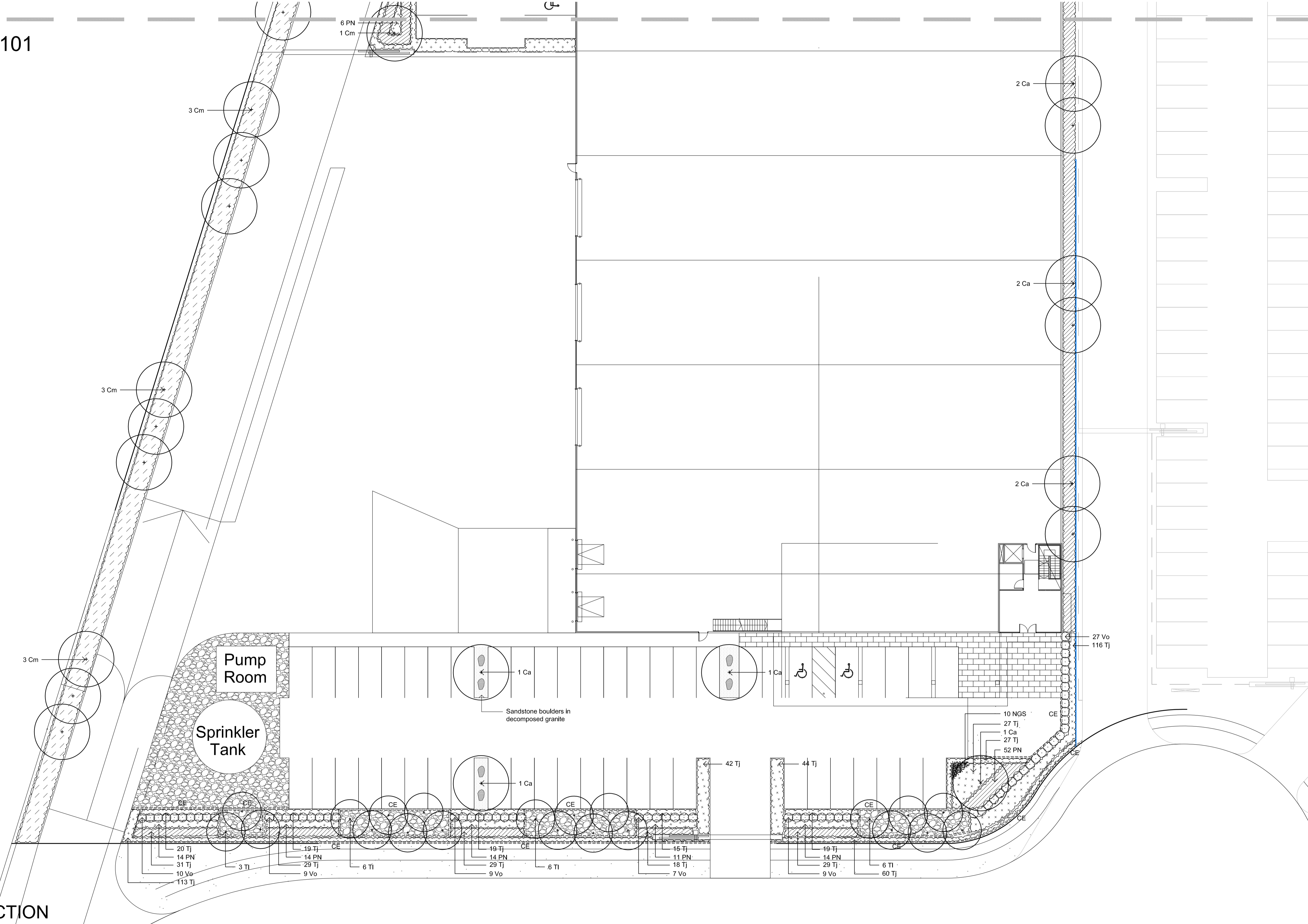

NOT FOR CONSTRUCTION

© 2014 Site Image (NSW) Pty Ltd ABN 44 801 262 380 as agent for Site Image NSW Partnership. All rights reserved. This drawing is copyright and shall not be reproduced or copied in any form or by any means (graphic, electronic or mechanical including photocopy) without the written permission of Site Image (NSW) Pty Ltd. Any license, expressed or implied, to use this document for any purpose what so ever is restricted to the terms of the written agreement between Site Image (NSW) Pty Ltd and the instructing party.

The contractor shall check and verify all work on site (including work by others) before commencing the landscape installation. Any discrepancies are to be reported to the Project Manager or Landscape Architect prior to commencing work. Do not scale this drawing. Any required dimensions not shown shall be referred to the Landscape Architect for confirmation.

Issue	Revision Description	Drawn	Check	Date
B	Plant Species Adjusted	JW	NM	02.06.2016
A	For Comment	JW	NM	24.05.2016

**LEGEND**

	Property Boundary		Proposed Shrubs and Accents		'Kwik Kerb' Concrete Edge refer specification (Not Part of these works)
	Proposed Trees		Turf		Sandstone Boulders in Decomposed Granite
	Proposed Grasses and Groundcovers		Feature Rock Ballast		

Key Plan:

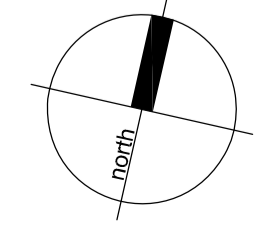

**SITE IMAGE**  
Landscape Architects  
Level 1, 3-5 Baptist Street  
Redfern NSW 2016  
Australia  
Tel: (61 2) 8332 5600  
Fax: (61 2) 9698 2877  
www.siteimage.com.au

Client:  
**Goodman**

Project:  
**Proposed Industrial Facility  
Oakdale Central Lot 3A  
Horsley Park, NSW**

Drawing Name:  
**Landscape Plan**

Scale: 1:200 @ A1  
Job Number:  
**SS13-2656**

**TENDER**

0 1 2 4 6 10m  
Drawing Number: Issue:  
**102 B**

PLANT SCHEDULE							
Symbol	Botanical Name	Common Name	Mature Height (m.)	Mature Spread (m.)	Spacings	Pot Size	Quantity
<b>Trees</b>							
Ca	<i>Cupaniopsis anacardioides</i>	Tuckeroo	10	5	As Shown	75L	18
Cm	<i>Corymbia maculata</i>	Spotted Gum	20	8	As Shown	45L	27
Tl	<i>Tristaniopsis laurina 'Luscious'</i>	Water Gum	9	8	As Shown	75L	21
<b>Shrubs</b>							
NGS	<i>Nandina 'Gulf Stream'</i>	Dwarf nandina	0.5	0.5	As Shown	200mm	10
Vo	<i>Viburnum odoratissimum</i>	Sweet Viburnum	5	3.5	As Shown	300mm	134
<b>Groundcovers / Grasses</b>							
Gt	<i>Gazania tomentosa</i>	Siler Leaf Gazania	0.15	1	3/m2	150mm	190
PN	<i>Pennisetum 'Nafray'</i>	Nafray Pennisetum	0.6	0.6	2/m2	Tube	1436
Tj	<i>Trachelospermum jasminoides</i>	Star Jasmine	0.2	0.5	4/m2	150mm	2725

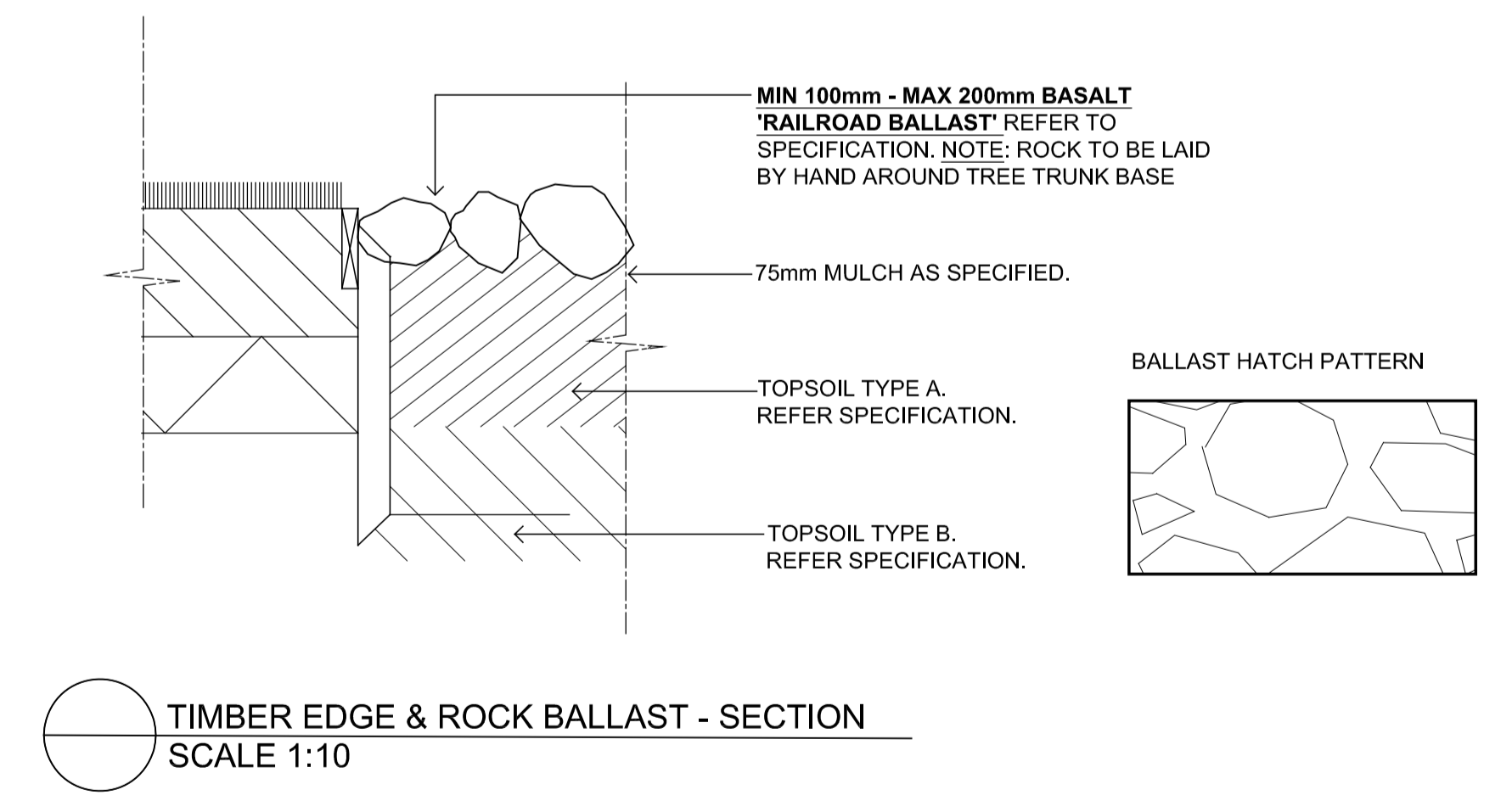
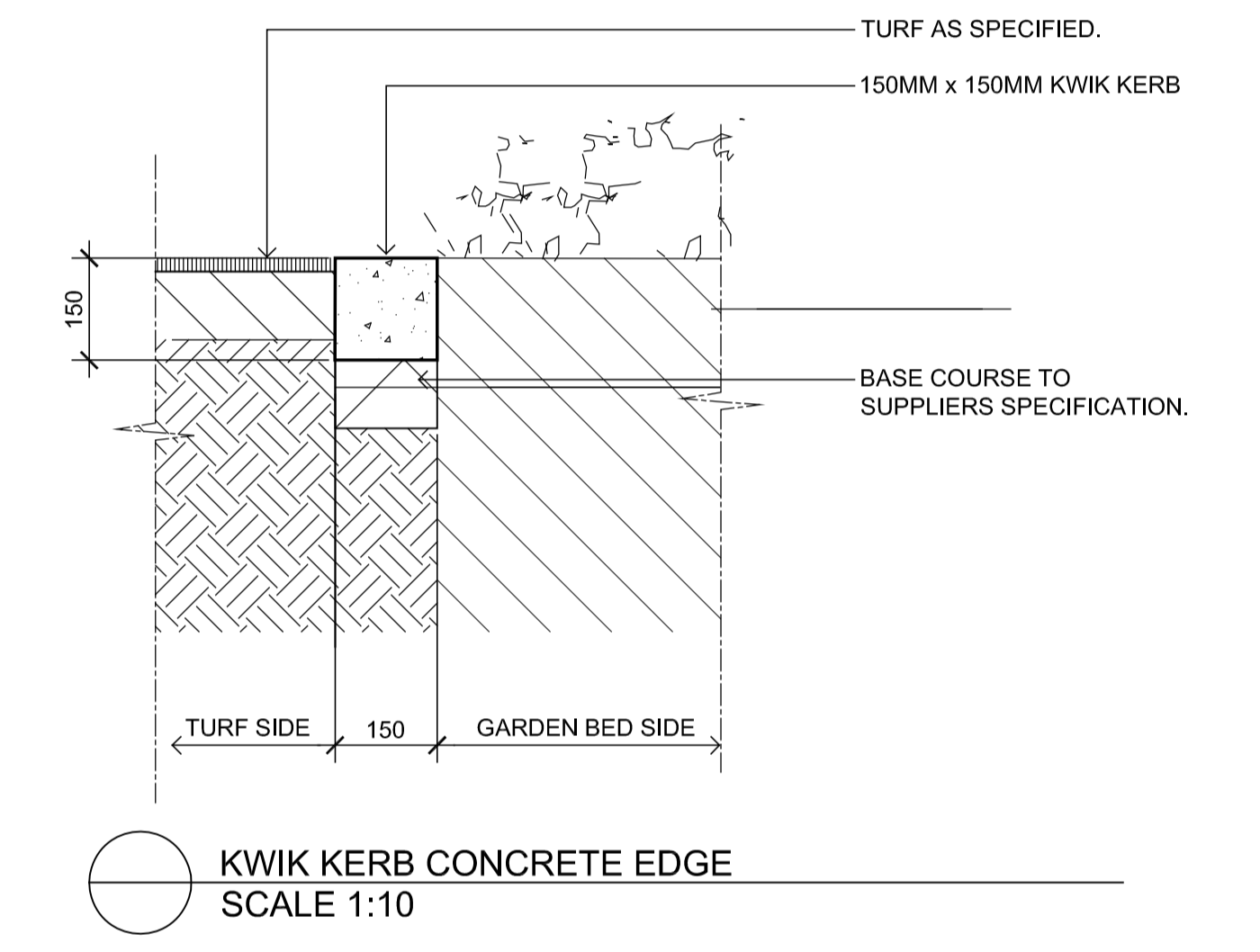
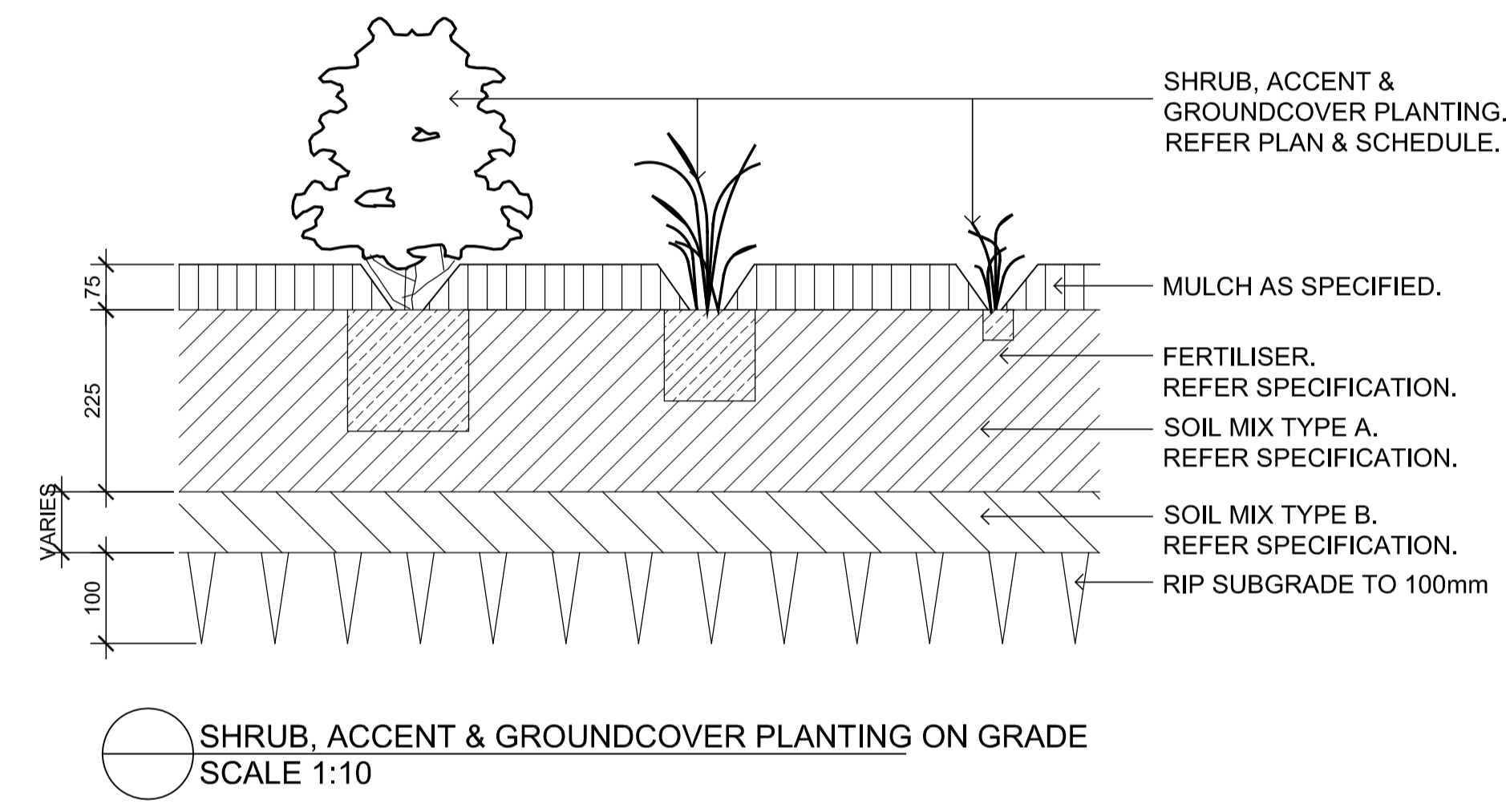
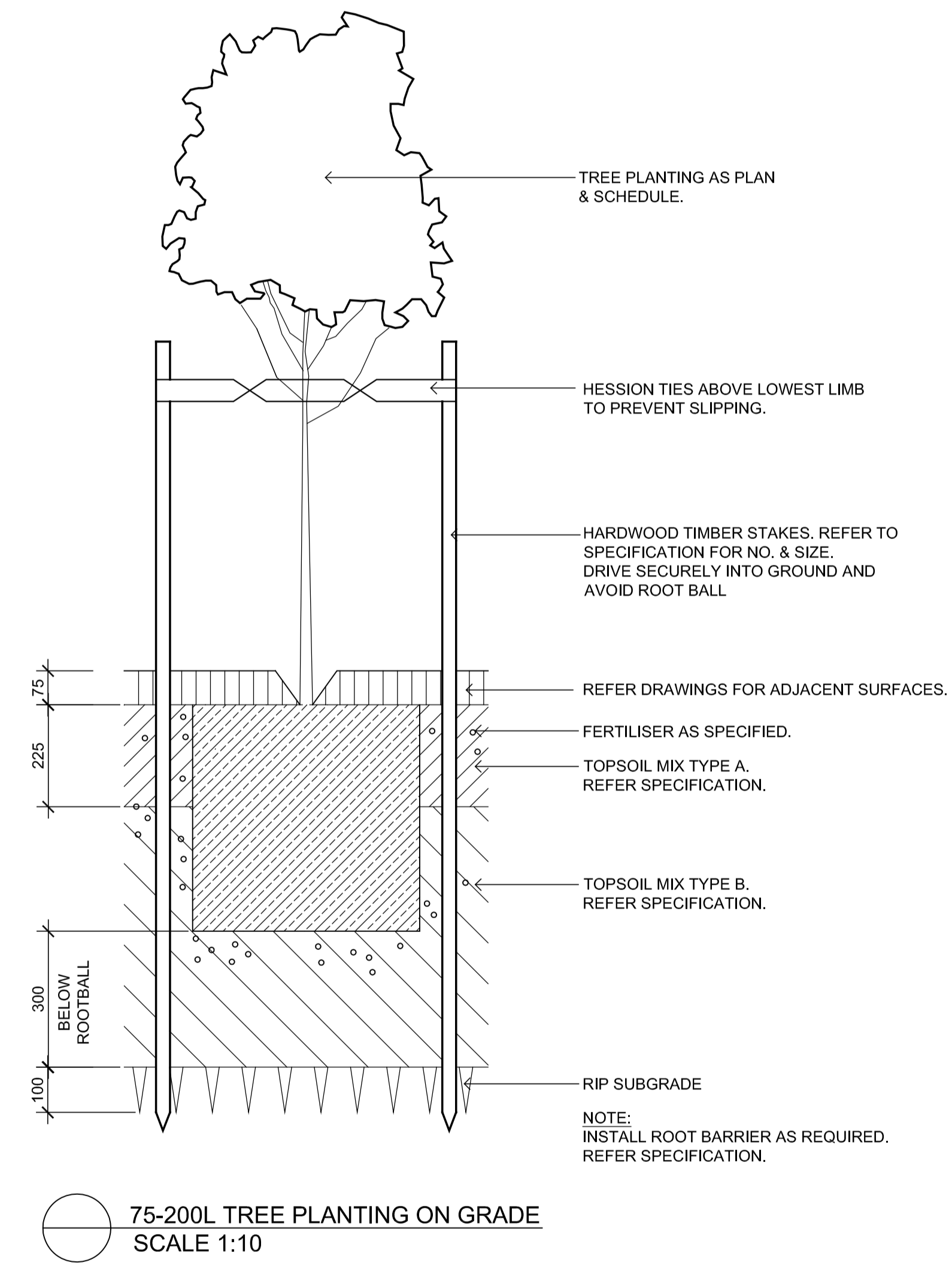
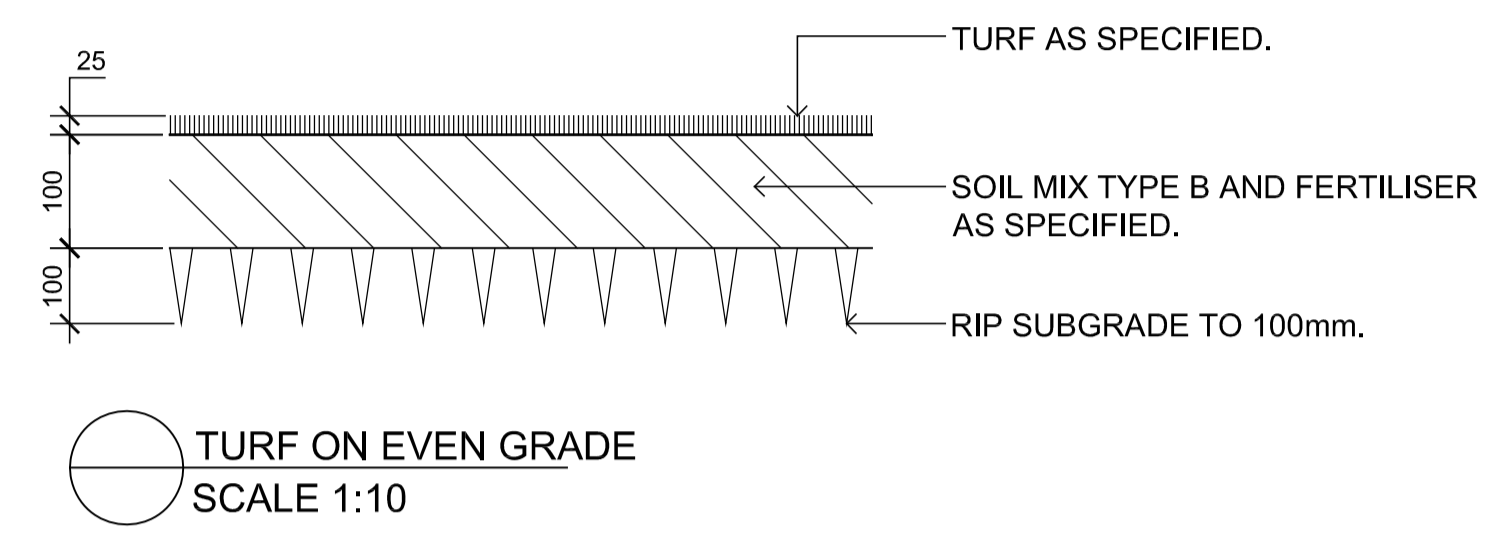
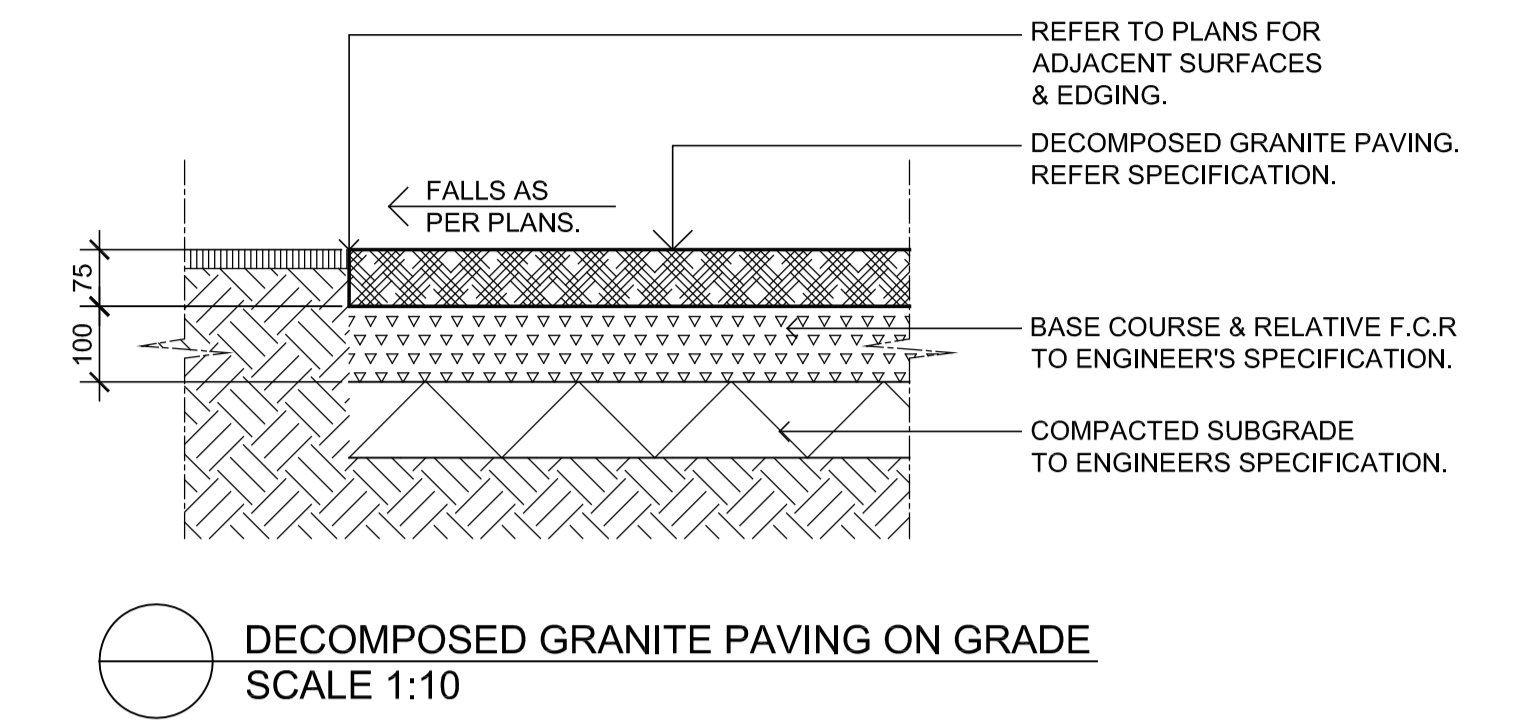

NOT FOR CONSTRUCTION

© 2014 Site Image (NSW) Pty Ltd ABN 44 801 262 380 as agent for Site Image NSW Partnership. All rights reserved. This drawing is copyright and shall not be reproduced or copied in any form or by any means (graphic, electronic or mechanical including photocopy) without the written permission of Site Image (NSW) Pty Ltd. Any license, expressed or implied, to use this document for any purpose what so ever is restricted to the terms of the written agreement between Site Image (NSW) Pty Ltd and the instructing party.

The contractor shall check and verify all work on site (including work by others) before commencing the landscape installation. Any discrepancies are to be reported to the Project Manager or Landscape Architect prior to commencing work. Do not scale this drawing. Any required dimensions not shown shall be referred to the Landscape Architect for confirmation.

Issue	Revision Description	Drawn	Check	Date
B	Plant Species Adjusted	JW	NM	02.06.2016
A	For Comment	JW	NM	24.05.2016

LEGEND

Key Plan:

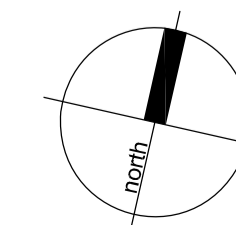

SITE IMAGE



Landscape Architects  
 Level 1, 3-5 Baptist Street  
 Redfern NSW 2016  
 Australia  
 Tel: (61 2) 8332 5600  
 Fax: (61 2) 9698 2877  
 www.siteimage.com.au

Client:

Goodman

Project:

Proposed Industrial Facility  
 Oakdale Central Lot 3A  
 Horsley Park, NSW

Drawing Name:

Landscape Details

Scale:

Job Number:  
 SS13-2656

TENDER

Drawing Number:

Issue:

501 B

# PROPOSED INDUSTRIAL FACILITY

Oakdale Central Lot 3C,  
HORSLEY PARK, NSW  
LANDSCAPE TENDER

## DRAWINGS

DWG NO.	DRAWING TITLE	SCALE
000	COVERSHEET	N/A
101	LANDSCAPE PLAN	1:200
102	LANDSCAPE PLAN	1:200
103	LANDSCAPE PLAN	1:200
104	LANDSCAPE PLAN	1:200
105	LANDSCAPE PLAN	1:200
106	LANDSCAPE PLAN	1:200
501	LANDSCAPE DETAILS	AS SHOWN

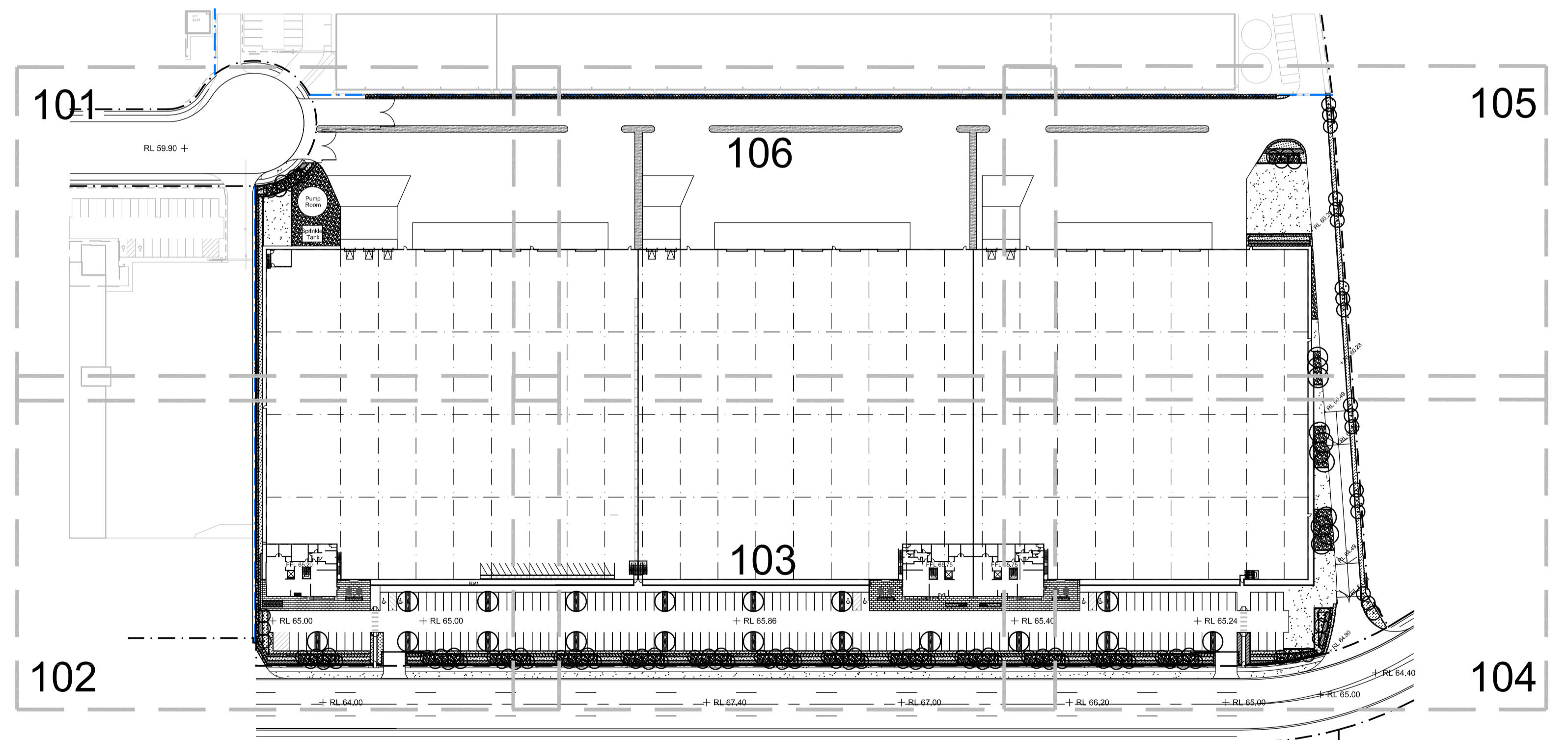

NOT FOR CONSTRUCTION

© 2014 Site Image (NSW) Pty Ltd ABN 44 801 262 380 as agent for Site Image NSW Partnership. All rights reserved. This drawing is copyright and shall not be reproduced or copied in any form or by any means (graphic, electronic or mechanical including photocopy) without the written permission of Site Image (NSW) Pty Ltd Any license, expressed or implied, to use this document for any purpose what so ever is restricted to the terms of the written agreement between Site Image (NSW) Pty Ltd and the instructing party.

The contractor shall check and verify all work on site (including work by others) before commencing the landscape installation. Any discrepancies are to be reported to the Project Manager or Landscape Architect prior to commencing work. Do not scale this drawing. Any required dimensions not shown shall be referred to the Landscape Architect for confirmation.

## LEGEND

Issue	Revision Description	Drawn	Check	Date
C	Plant Species Adjusted	JW	NM	01.06.2016
B	Pump Relocation	JW	NM	31.05.2016
A	For Comment	JW	NM	25.05.2016

Key Plan:

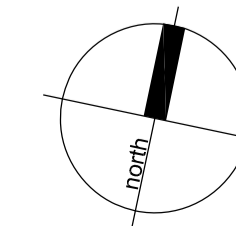

SITE IMAGE



Landscape Architects  
Level 1, 3-5 Baptist Street  
Redfern NSW 2016  
Australia  
Tel: (61 2) 8332 5600  
Fax: (61 2) 9698 2877  
www.siteimage.com.au

Client:

Goodman

Project:

Proposed Industrial Facility  
Oakdale Central Lot 3C  
Horsley Park, NSW

Drawing Name:

Coversheet

Job Number:

SS13-2656

TENDER

Drawing Number:

Issue:  
000 C



Continues DWG 103

Continues DWG 102

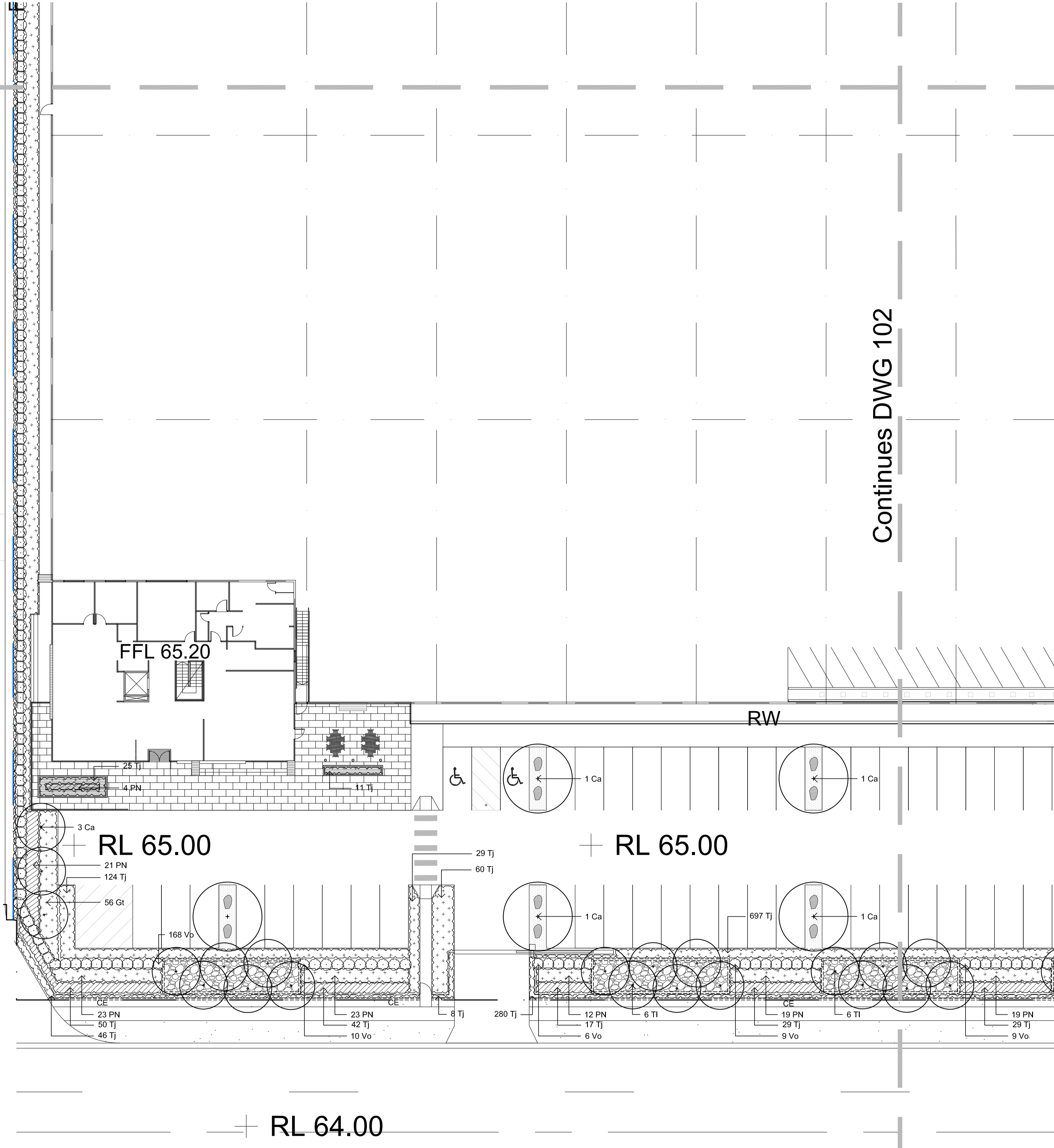

NOT FOR CONSTRUCTION

© 2014 Site Image (NSW) Pty Ltd ABN 44 801 262 380 as agent for Site Image NSW Partnership. All rights reserved. This drawing is copyright and shall not be reproduced or copied in any form or by any means (graphic, electronic or mechanical including photocopy) without the written permission of Site Image (NSW) Pty Ltd. Any license, expressed or implied, to use this document for any purpose what so ever is restricted to the terms of the written agreement between Site Image (NSW) Pty Ltd and the instructing party.

The contractor shall check and verify all work on site (including work by others) before commencing the landscape installation. Any discrepancies are to be reported to the Project Manager or Landscape Architect prior to commencing work. Do not scale this drawing. Any required dimensions not shown shall be referred to the Landscape Architect for confirmation.

Issue	Revision Description	Drawn	Check	Date
B	Plant Species Adjusted	JW	NM	01.06.2016
A	For Comment	JW	NM	25.05.2016

LEGEND	
	Property Boundary
	Proposed Trees
	Proposed Grasses and Groundcovers
	Proposed Shrubs and Accents
	Turf
	Feature Rock Ballast
	'Kwik Kerb' Concrete Edge refer specification (Not Part of these works)
	Sandstone Boulders in Decomposed Granite
	Mulch

Key Plan:

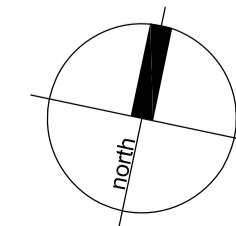

**SITE IMAGE**  
Landscape Architects  
Level 1, 3-5 Baptist Street  
Redfern NSW 2016  
Australia  
Tel: (61 2) 8332 5600  
Fax: (61 2) 9698 2877  
www.siteimage.com.au

Client:  
**Goodman**

Project:  
**Proposed Industrial Facility  
Oakdale Central Lot 3C  
Horsely Park, NSW**

Drawing Name:  
**Landscape Plan**

Scale: 1:200 @ A1  
Job Number:  
**SS13-2656**

**TENDER**

0 1 2 4 6 10m  
Drawing Number: Issue:  
**102 B**

Continues DWG 102

Continues DWG 104

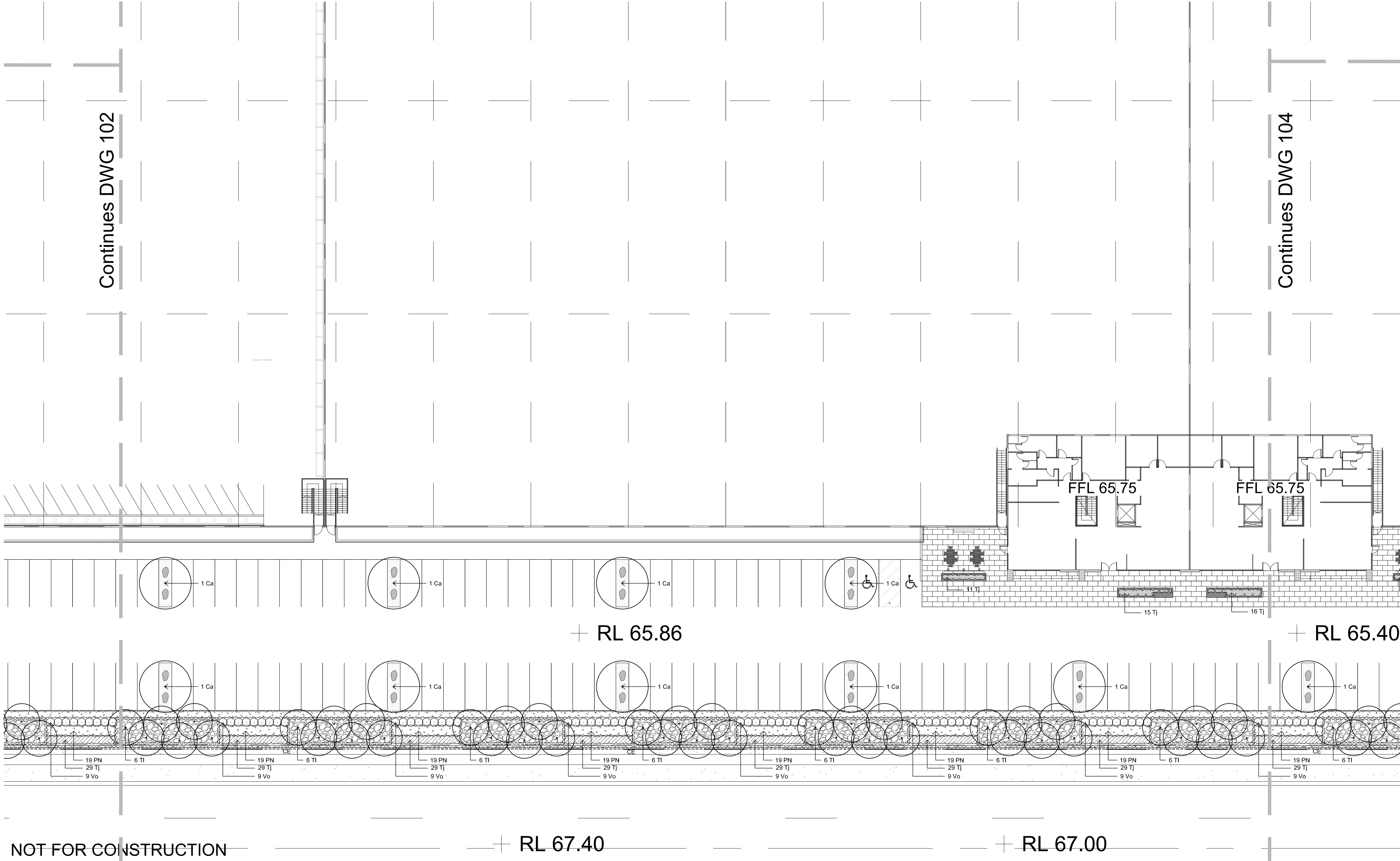

NOT FOR CONSTRUCTION

© 2014 Site Image (NSW) Pty Ltd ABN 44 801 262 380 as agent for Site Image NSW Partnership. All rights reserved. This drawing is copyright and shall not be reproduced or copied in any form or by any means (graphic electronic or mechanical including photocopy) without the written permission of Site Image (NSW) Pty Ltd. Any license, expressed or implied, to use this document for any purpose what so ever is restricted to the terms of the written agreement between Site Image (NSW) Pty Ltd and the instructing party.

The contractor shall check and verify all work on site (including work by others) before commencing the landscape installation. Any discrepancies are to be reported to the Project Manager or Landscape Architect prior to commencing work. Do not scale this drawing. Any required dimensions not shown shall be referred to the Landscape Architect for confirmation.

Issue	Revision Description	Drawn	Check	Date
A	For Comment	JW	NM	25.05.2016

LEGEND	
	Property Boundary
	Proposed Trees
	Proposed Grasses and Groundcovers
	Proposed Shrubs and Accents
	Turf
	Feature Rock Ballast
	'Kwik Kerb' Concrete Edge refer specification (Not Part of these works)
	Sandstone Boulders in Decomposed Granite
	Mulch

Key Plan:

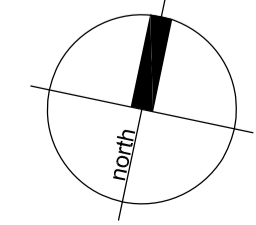

**SITE IMAGE**  
Landscape Architects  
Level 1, 3-5 Baptist Street  
Redfern NSW 2016  
Australia  
Tel: (61 2) 8332 5600  
Fax: (61 2) 9698 2877  
www.siteimage.com.au

Client:  
**Goodman**

Project:  
**Proposed Industrial Facility  
Oakdale Central Lot 3C  
Horsely Park, NSW**

Drawing Name:  
**Landscape Plan**

Scale: 1:200 @ A1  
Job Number:  
**SS13-2656**

**TENDER**

0 1 2 4 6 10m  
Drawing Number: Issue:  
**103 A**

Continues DWG 103

Continues DWG 105

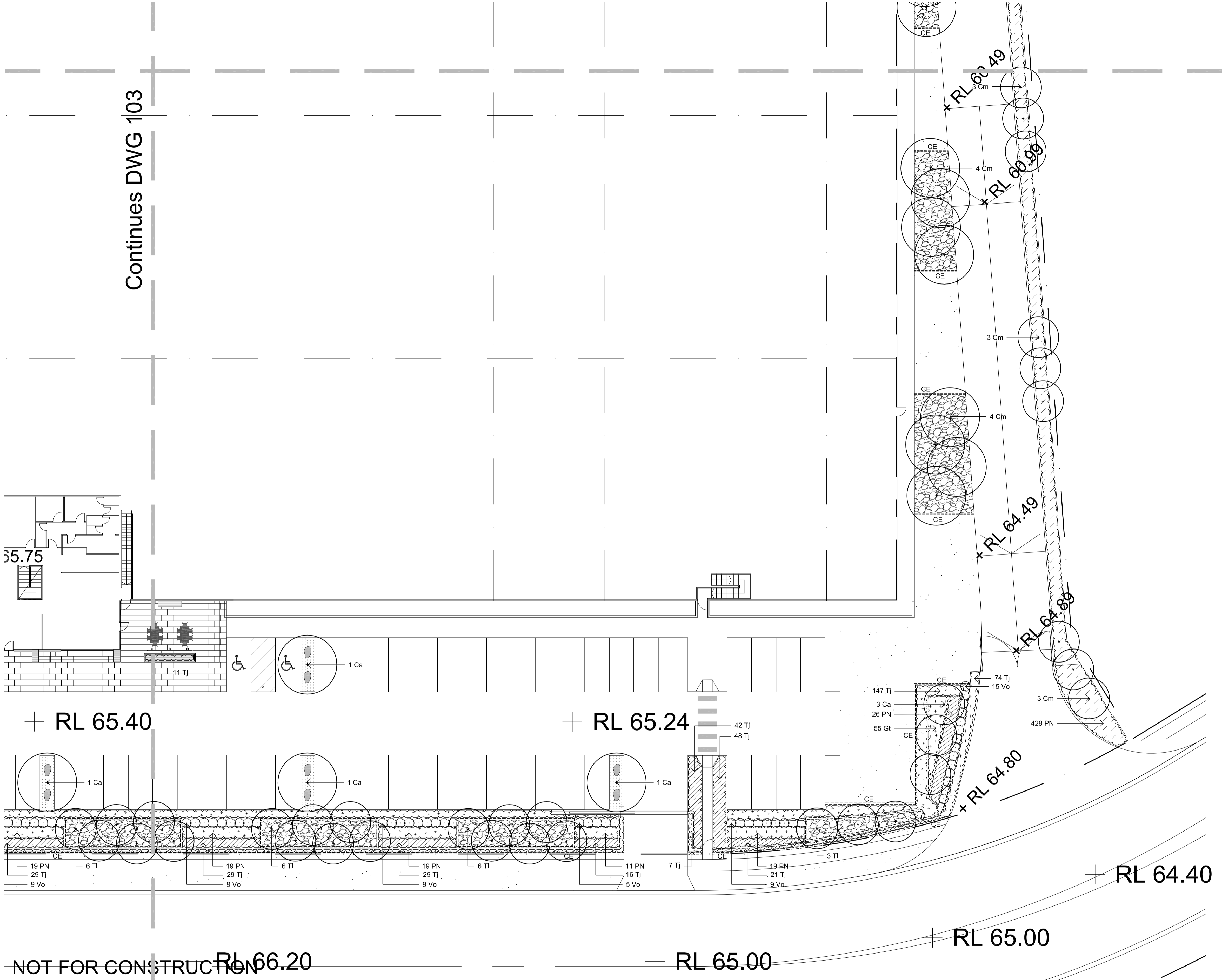

NOT FOR CONSTRUCTION

© 2014 Site Image (NSW) Pty Ltd. All rights reserved. This drawing is copyright and shall not be reproduced or copied in any form or by any means (graphic, electronic or mechanical including photocopy) without the written permission of Site Image (NSW) Pty Ltd. Any license, expressed or implied, to use this document for any purpose what so ever is restricted to the terms of the written agreement between Site Image (NSW) Pty Ltd and the instructing party.

The contractor shall check and verify all work on site (including work by others) before commencing the landscape installation. Any discrepancies are to be reported to the Project Manager or Landscape Architect prior to commencing work. Do not scale this drawing. Any required dimensions not shown shall be referred to the Landscape Architect for confirmation.

Issue	Revision Description	Drawn	Check	Date
B	Plant Species Adjusted	JW	NM	01.06.2016
A	For Comment	JW	NM	25.05.2016

LEGEND	
	Property Boundary
	Proposed Trees
	Proposed Grasses and Groundcovers
	Proposed Shrubs and Accents
	Turf
	Feature Rock Ballast
	'Kwik Kerb' Concrete Edge refer specification (Not Part of these works)
	Sandstone Boulders in Decomposed Granite
	Mulch

Key Plan:

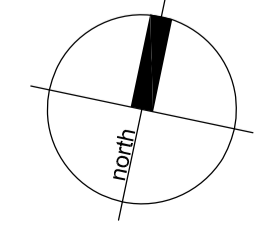

**SITE IMAGE**  
Landscape Architects  
Level 1, 3-5 Baptist Street  
Redfern NSW 2016  
Australia  
Tel: (61 2) 8332 5600  
Fax: (61 2) 9698 2877  
www.siteimage.com.au

Client:  
**Goodman**

Project:  
**Proposed Industrial Facility  
Oakdale Central Lot 3C  
Horsely Park, NSW**

Drawing Name:  
**Landscape Plan**

Scale: 1:200 @ A1  
Job Number:  
**SS13-2656**

**TENDER**

0 1 2 4 6 10m  
Drawing Number: Issue:  
**104 B**

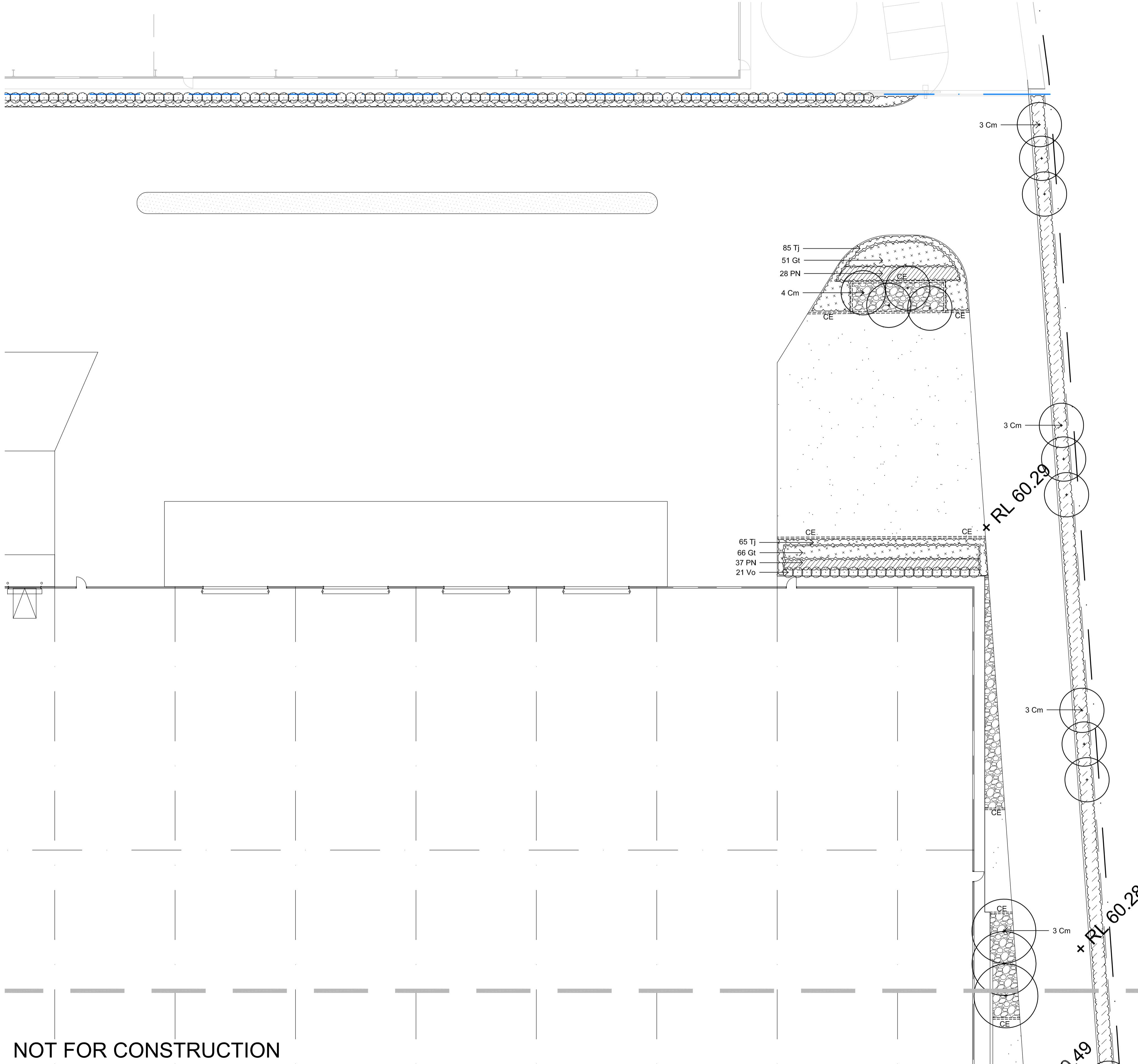

NOT FOR CONSTRUCTION

Continues DWG 104

© 2014 Site Image (NSW) Pty Ltd ABN 44 801 262 380 as agent for Site Image NSW Partnership. All rights reserved. This drawing is copyright and shall not be reproduced or copied in any form or by any means (graphic, electronic or mechanical including photocopy) without the written permission of Site Image (NSW) Pty Ltd. Any license, expressed or implied, to use this document for any purpose what so ever is restricted to the terms of the written agreement between Site Image (NSW) Pty Ltd and the instructing party.

The contractor shall check and verify all work on site (including work by others) before commencing the landscape installation. Any discrepancies are to be reported to the Project Manager or Landscape Architect prior to commencing work. Do not scale this drawing. Any required dimensions not shown shall be referred to the Landscape Architect for confirmation.

Issue	Revision Description	Drawn	Check	Date
C	Plant Species Adjusted	JW	NM	01.06.2016
B	Pump Relocation	JW	NM	31.05.2016
A	For Comment	JW	NM	25.05.2016

LEGEND	
	Property Boundary
	Proposed Trees
	Proposed Grasses and Groundcovers
	Proposed Shrubs and Accents
	Turf
	Feature Rock Ballast
	'Kwik Kerb' Concrete Edge refer specification (Not Part of these works)
	Sandstone Boulders in Decomposed Granite
	Mulch

Key Plan:

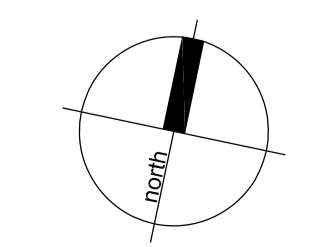

**SITE IMAGE**  
Landscape Architects  
Level 1, 3-5 Baptist Street  
Redfern NSW 2016  
Australia  
Tel: (61 2) 8332 5600  
Fax: (61 2) 9698 2877  
www.siteimage.com.au

Client:  
**Goodman**

Project:  
**Proposed Industrial Facility  
Oakdale Central Lot 3C  
Horsely Park, NSW**

Drawing Name:  
**Landscape Plan**

Scale: 1:200 @ A1  
Job Number:  
**SS13-2656**

**TENDER**

0 1 2 4 6 10m  
Drawing Number: Issue:  
**105 C**

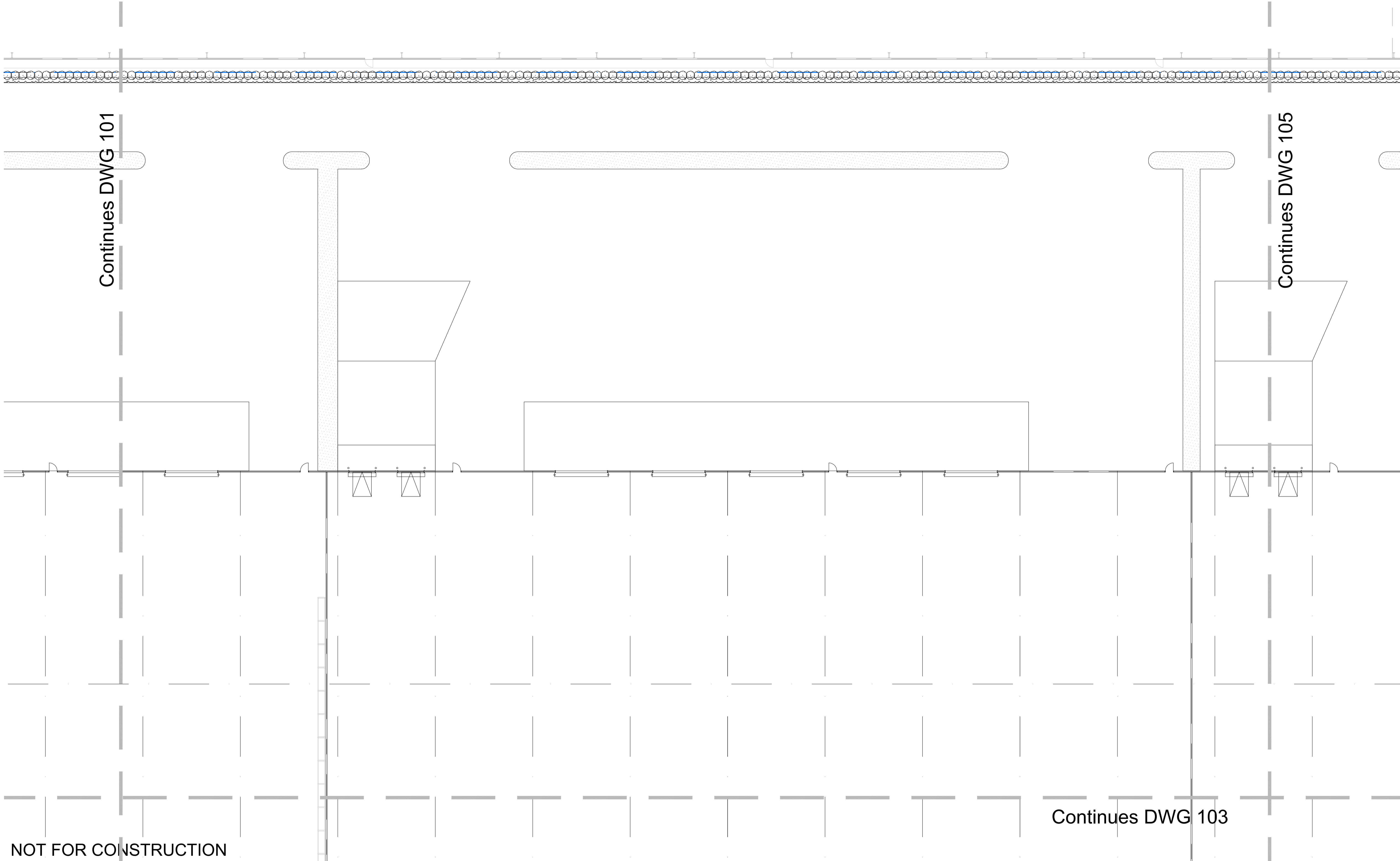

**NOT FOR CONSTRUCTION**

© 2014 Site Image (NSW) Pty Ltd ABN 44 801 262 380 as agent for Site Image NSW Partnership. All rights reserved. This drawing is copyright and shall not be reproduced or copied in any form or by any means (graphic, electronic or mechanical including photocopy) without the written permission of Site Image (NSW) Pty Ltd. Any license, expressed or implied, to use this document for any purpose what so ever is restricted to the terms of the written agreement between Site Image (NSW) Pty Ltd and the instructing party.

The contractor shall check and verify all work on site (including work by others) before commencing the landscape installation. Any discrepancies are to be reported to the Project Manager or Landscape Architect prior to commencing work. Do not scale this drawing. Any required dimensions not shown shall be referred to the Landscape Architect for confirmation.

Issue	Revision Description	Drawn	Check	Date
A	Pump Relocation	JW	NM	31.05.2016

LEGEND		Key Plan:	
	Property Boundary		Proposed Shrubs and Accents
	Proposed Trees		Turf
	Proposed Grasses and Groundcovers		Feature Rock Ballast
	'Kwik Kerb' Concrete Edge refer specification (Not Part of these works)		Sandstone Boulders in Decomposed Granite
	Mulch		

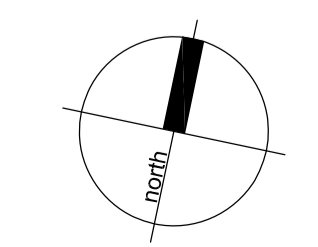

**SITE IMAGE**  
 Landscape Architects  
 Level 1, 3-5 Baptist Street  
 Redfern NSW 2016  
 Australia  
 Tel: (61 2) 8332 5600  
 Fax: (61 2) 9698 2877  
 www.siteimage.com.au

Client:  
**Goodman**

Project:  
**Proposed Industrial Facility  
 Oakdale Central Lot 3C  
 Horsely Park, NSW**

Drawing Name:  
**Landscape Plan**

Scale: 1:200 @ A1  
 Job Number:  
**SS13-2656**

**TENDER**

0 1 2 4 6 10m  
 Drawing Number: Issue:  
**106 A**

PLANT SCHEDULE							
Symbol	Botanical Name	Common Name	Mature Height (m.)	Mature Spread (m.)	Spacings	Pot Size	Quantity
<b>Trees</b>							
Ca	<i>Cupaniopsis anacardioides</i>	Tuckeroo	10	5	As Shown	75L	23
Cm	<i>Corymbia maculata</i>	Spotted Gum	20	8	As Shown	45L	33
TI	<i>Tristaniopsis laurina</i> 'Luscious'	Water Gum	9	8	As Shown	75L	81
<b>Shrubs</b>							
Vo	<i>Viburnum odoratissimum</i>	Sweet Viburnum	5	3.5	As Shown	300mm	641
<b>Groundcovers / Grasses</b>							
Gt	<i>Gazania tomentosa</i>	Silver Leaf Gazania	0.15	1	3/m2	150mm	228
PN	<i>Pennisetum 'Nafray'</i>	Nafray Pennisetum	0.6	0.6	2/m2	Tube	1245
Tj	<i>Trachelospermum jasminoides</i>	Star Jasmine	0.2	0.5	4/m2	150mm	2953

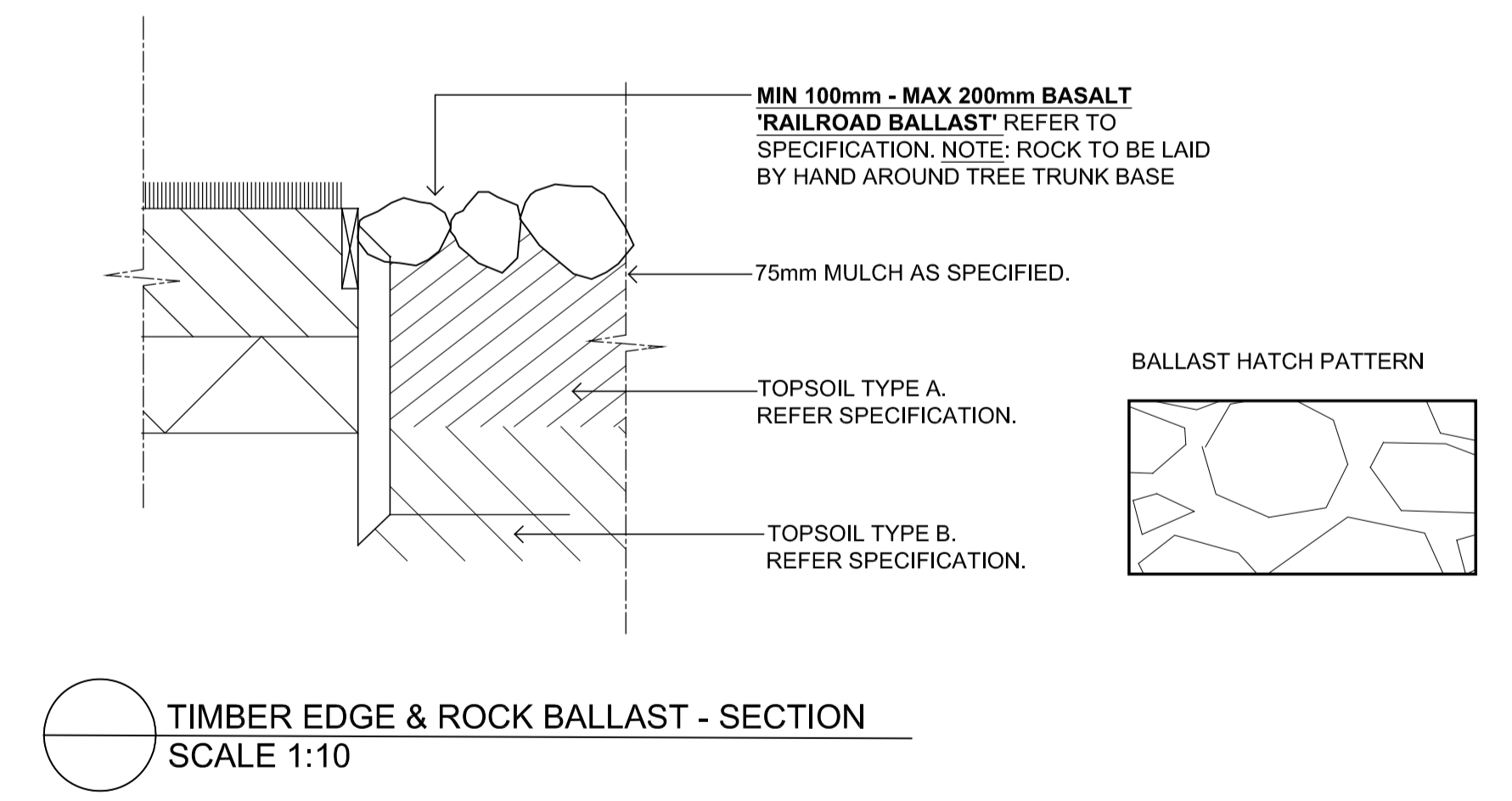
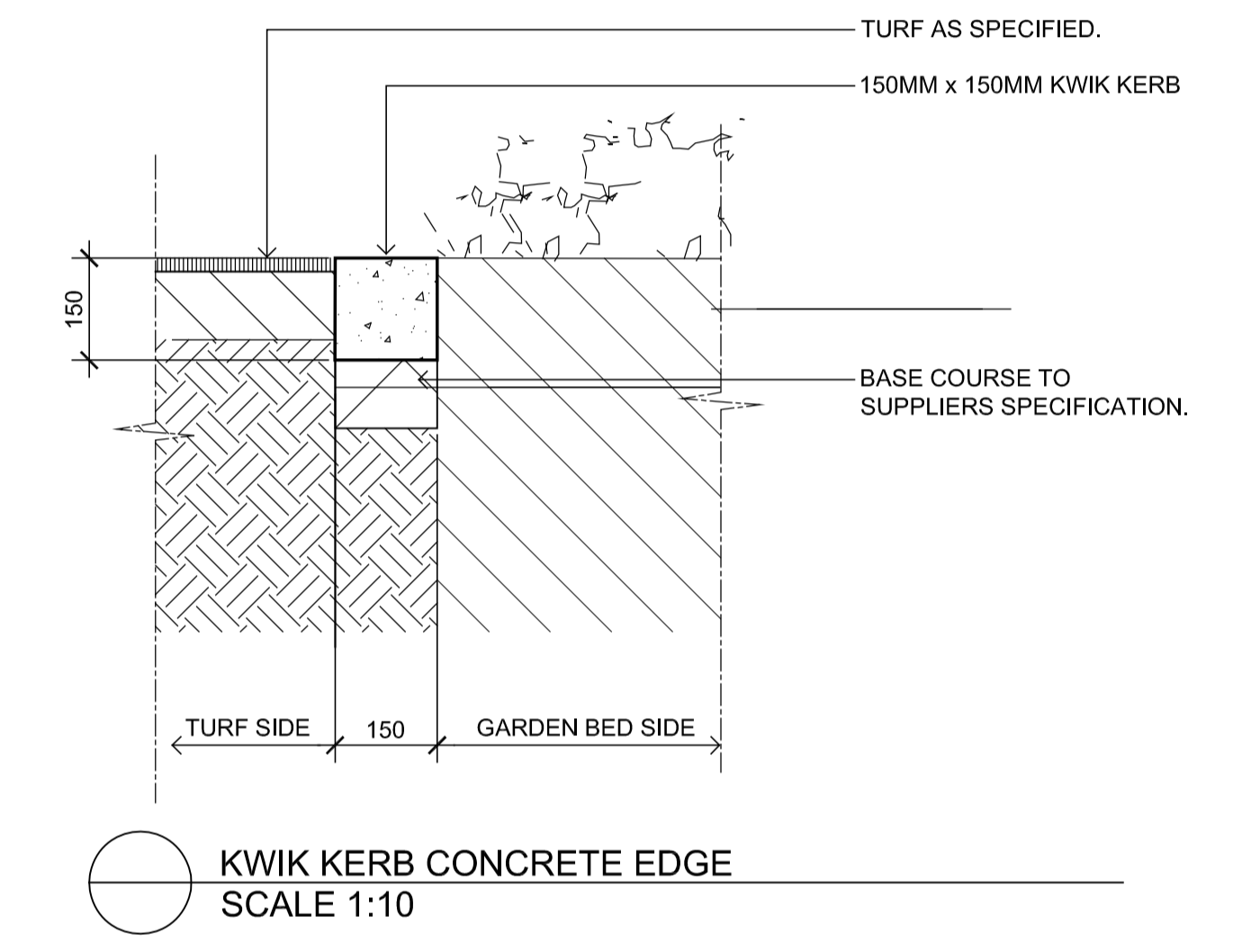
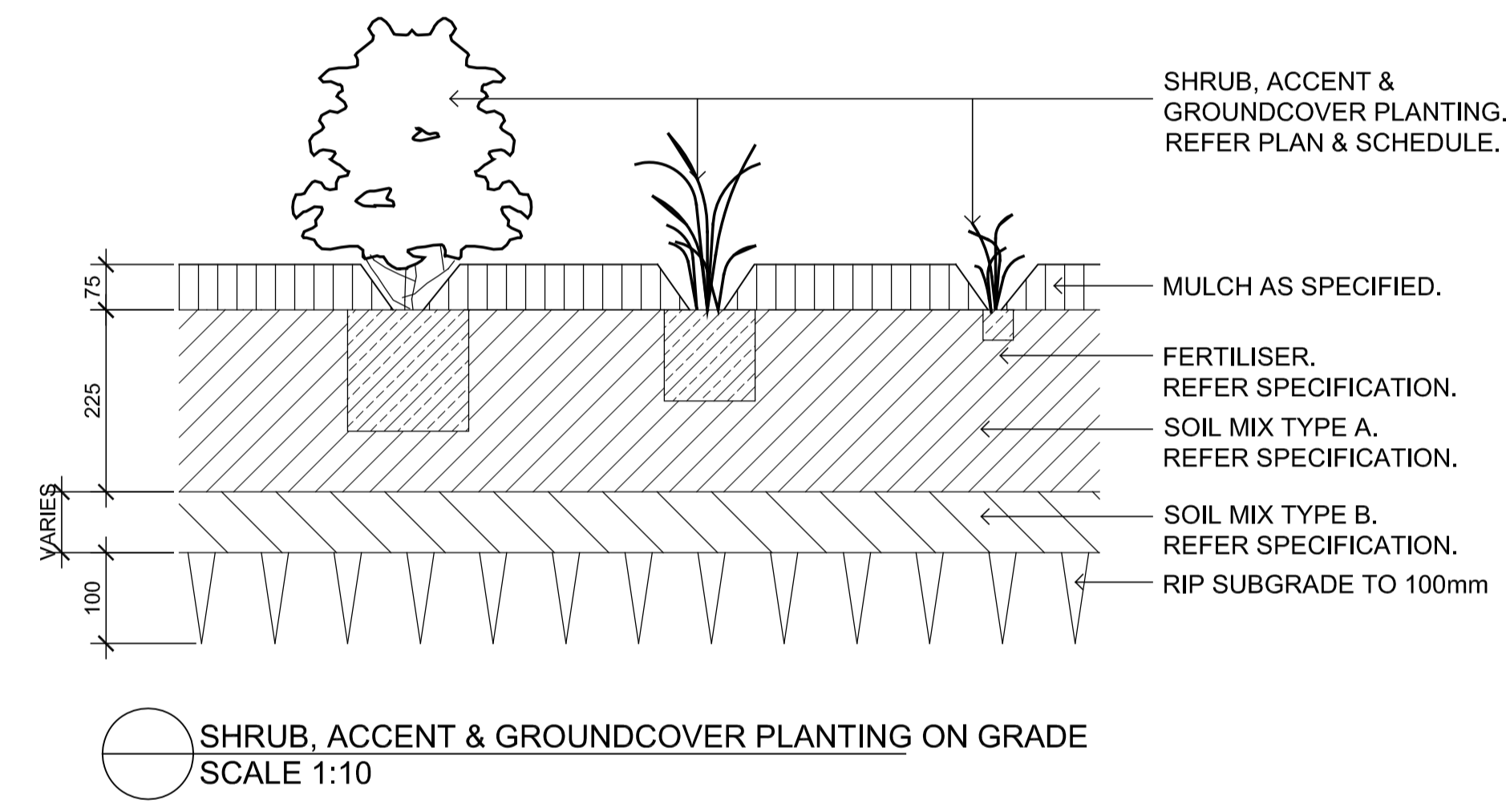
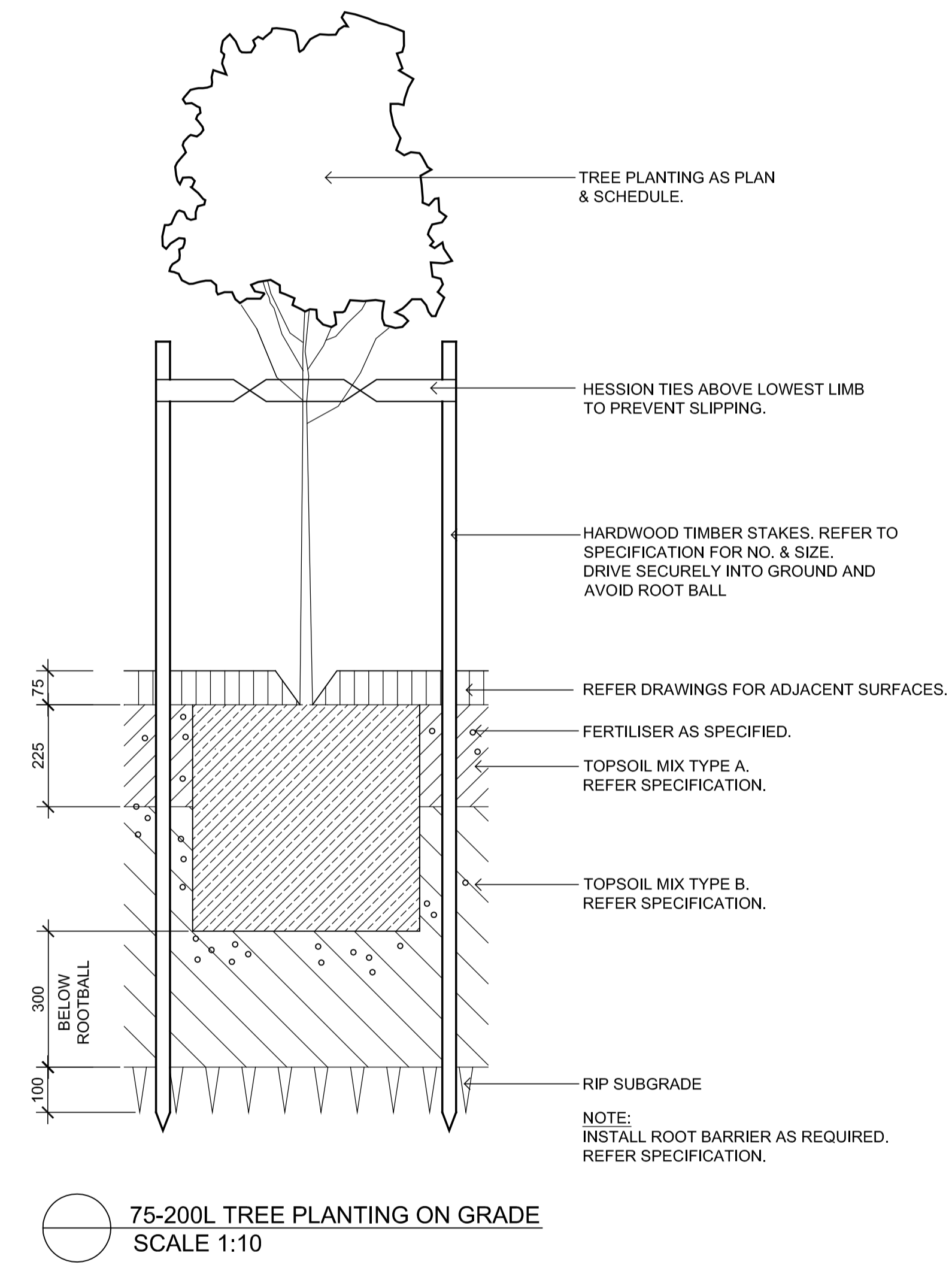
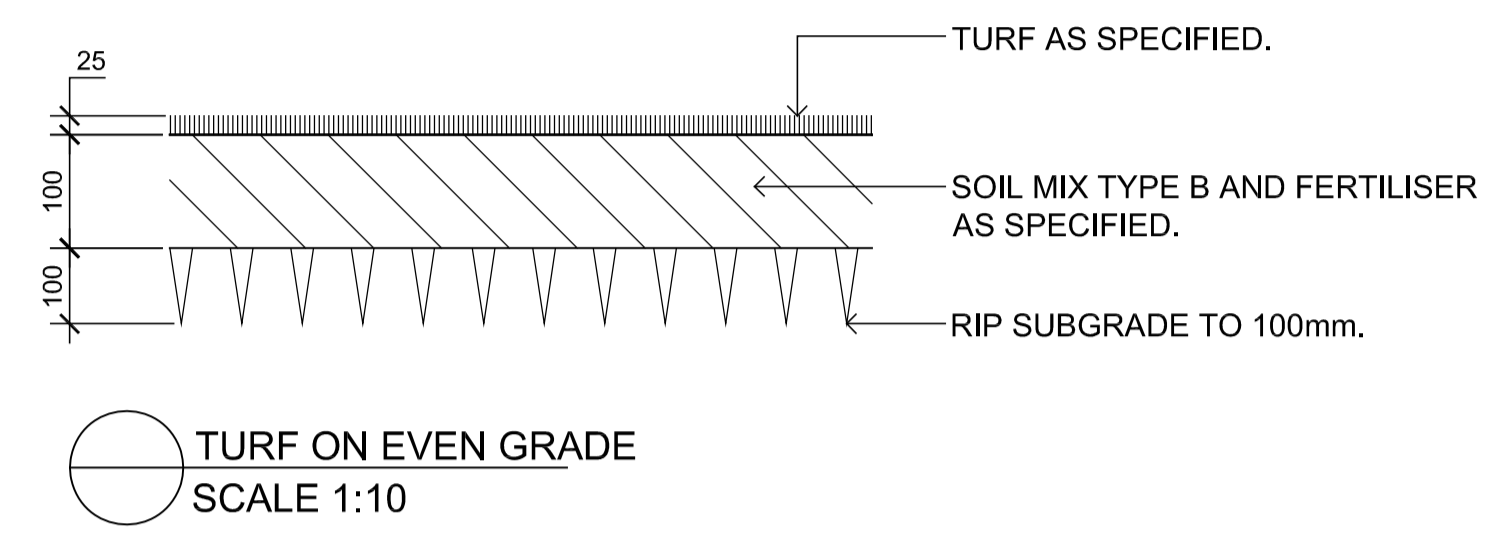
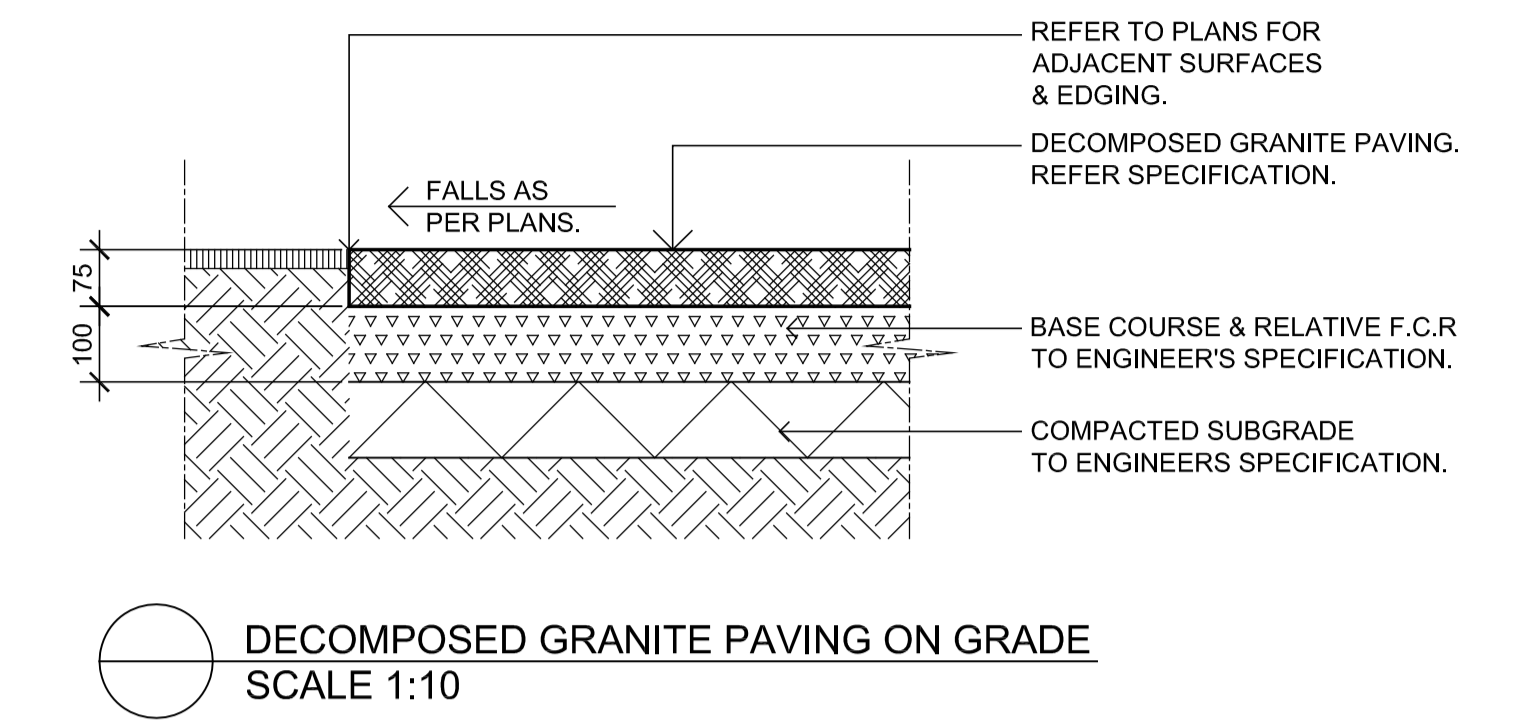

NOT FOR CONSTRUCTION

© 2014 Site Image (NSW) Pty Ltd ABN 44 801 262 380 as agent for Site Image NSW Partnership. All rights reserved. This drawing is copyright and shall not be reproduced or copied in any form or by any means (graphic, electronic or mechanical including photocopy) without the written permission of Site Image (NSW) Pty Ltd. Any license, expressed or implied, to use this document for any purpose whatsoever is restricted to the terms of the written agreement between Site Image (NSW) Pty Ltd and the instructing party.

The contractor shall check and verify all work on site (including work by others) before commencing the landscape installation. Any discrepancies are to be reported to the Project Manager or Landscape Architect prior to commencing work. Do not scale this drawing. Any required dimensions not shown shall be referred to the Landscape Architect for confirmation.

Issue	Revision Description	Drawn	Check	Date
B	Plant Species Adjusted	JW	NM	01.06.2016
A	For Comment	JW	NM	25.05.2016

LEGEND

Key Plan:

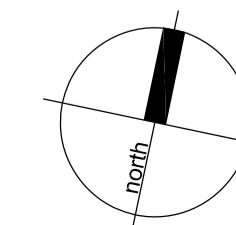

SITE IMAGE



Landscape Architects  
 Level 1, 3-5 Baptist Street  
 Redfern NSW 2016  
 Australia  
 Tel: (61 2) 8332 5600  
 Fax: (61 2) 9698 2877  
 www.siteimage.com.au

Client:  
**Goodman**

Project:  
**Proposed Industrial Facility  
 Oakdale Central Lot 3C  
 Horsely Park, NSW**

Drawing Name:  
**Landscape Details**

Job Number:  
**SS13-2656**

TENDER

Drawing Number:

Issue:  
**501 B**

# PROPOSED INDUSTRIAL FACILITY

Oakdale Central Lot 3D,  
HORSLEY PARK, NSW  
LANDSCAPE TENDER

## DRAWINGS

DWG NO.	DRAWING TITLE	SCALE
000	COVERSHEET	N/A
101	LANDSCAPE PLAN	1:200
102	LANDSCAPE PLAN	1:200
103	LANDSCAPE PLAN	1:200
501	LANDSCAPE DETAILS	AS SHOWN

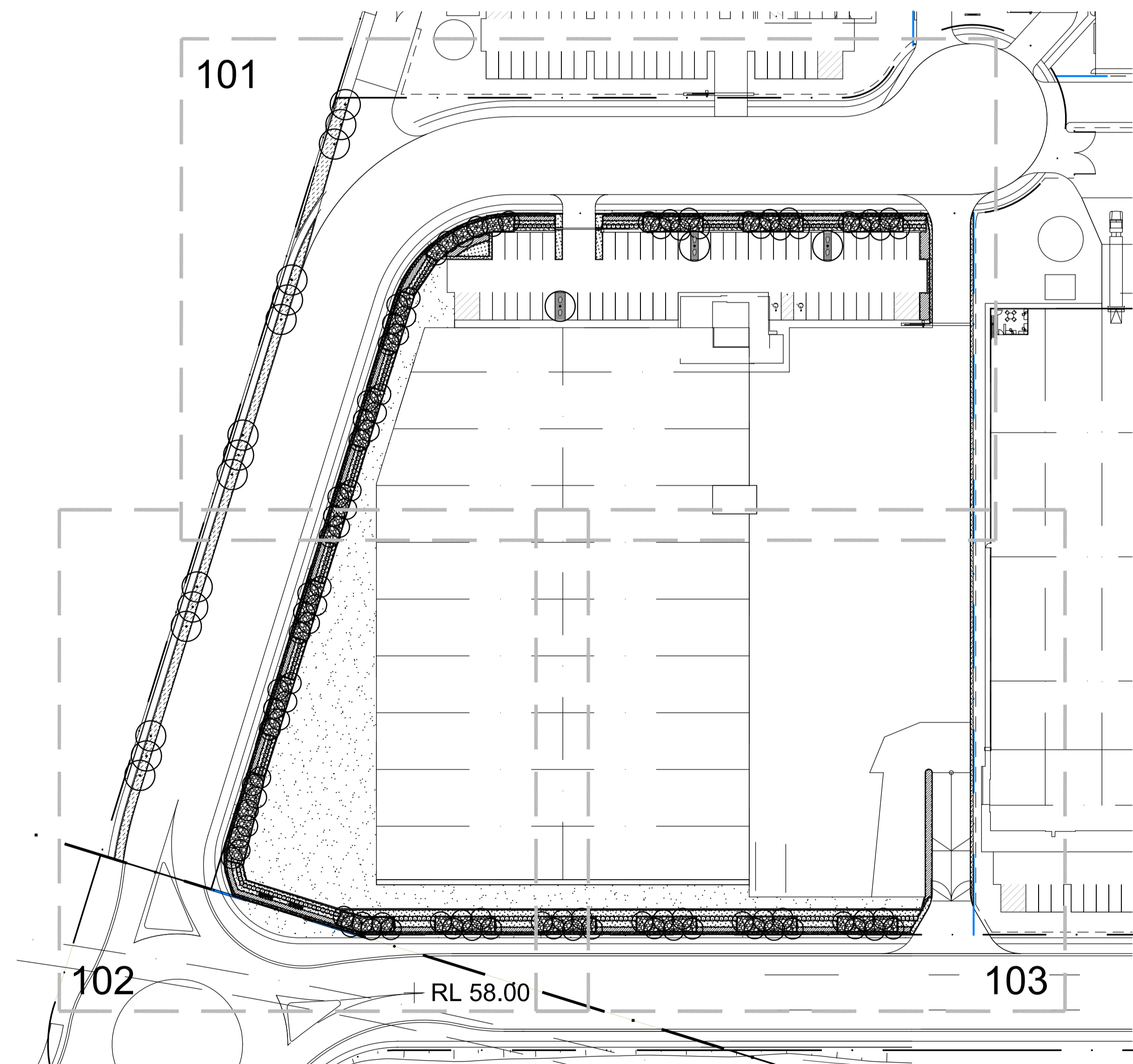

NOT FOR CONSTRUCTION

© 2014 Site Image (NSW) Pty Ltd ABN 44 801 262 380 as agent for Site Image NSW Partnership. All rights reserved. This drawing is copyright and shall not be reproduced or copied in any form or by any means (graphic, electronic or mechanical including photocopy) without the written permission of Site Image (NSW) Pty Ltd. Any license, expressed or implied, to use this document for any purpose what so ever is restricted to the terms of the written agreement between Site Image (NSW) Pty Ltd and the instructing party.

The contractor shall check and verify all work on site (including work by others) before commencing the landscape installation. Any discrepancies are to be reported to the Project Manager or Landscape Architect prior to commencing work. Do not scale this drawing. Any required dimensions not shown shall be referred to the Landscape Architect for confirmation.

## LEGEND

Issue	Revision Description	Drawn	Check	Date
C	Plant Species Adjusted	JW	NM	01.06.2016
B	Pump Relocation	JW	NM	31.05.2016
A	For Comment	JW	NM	27.05.2016

Key Plan:

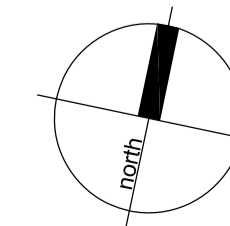

SITE IMAGE



Landscape Architects  
Level 1, 3-5 Baptist Street  
Redfern NSW 2016  
Australia  
Tel: (61 2) 8332 5600  
Fax: (61 2) 9698 2877  
www.siteimage.com.au

Client:

Goodman

Project:

Proposed Industrial Facility  
Oakdale Central Lot 3D  
Horsley Park, NSW

Drawing Name:

Coversheet

Job Number:  
SS13-2656

TENDER

Drawing Number:

Issue:  
000 C



Continues DWG 101

Continues DWG 103

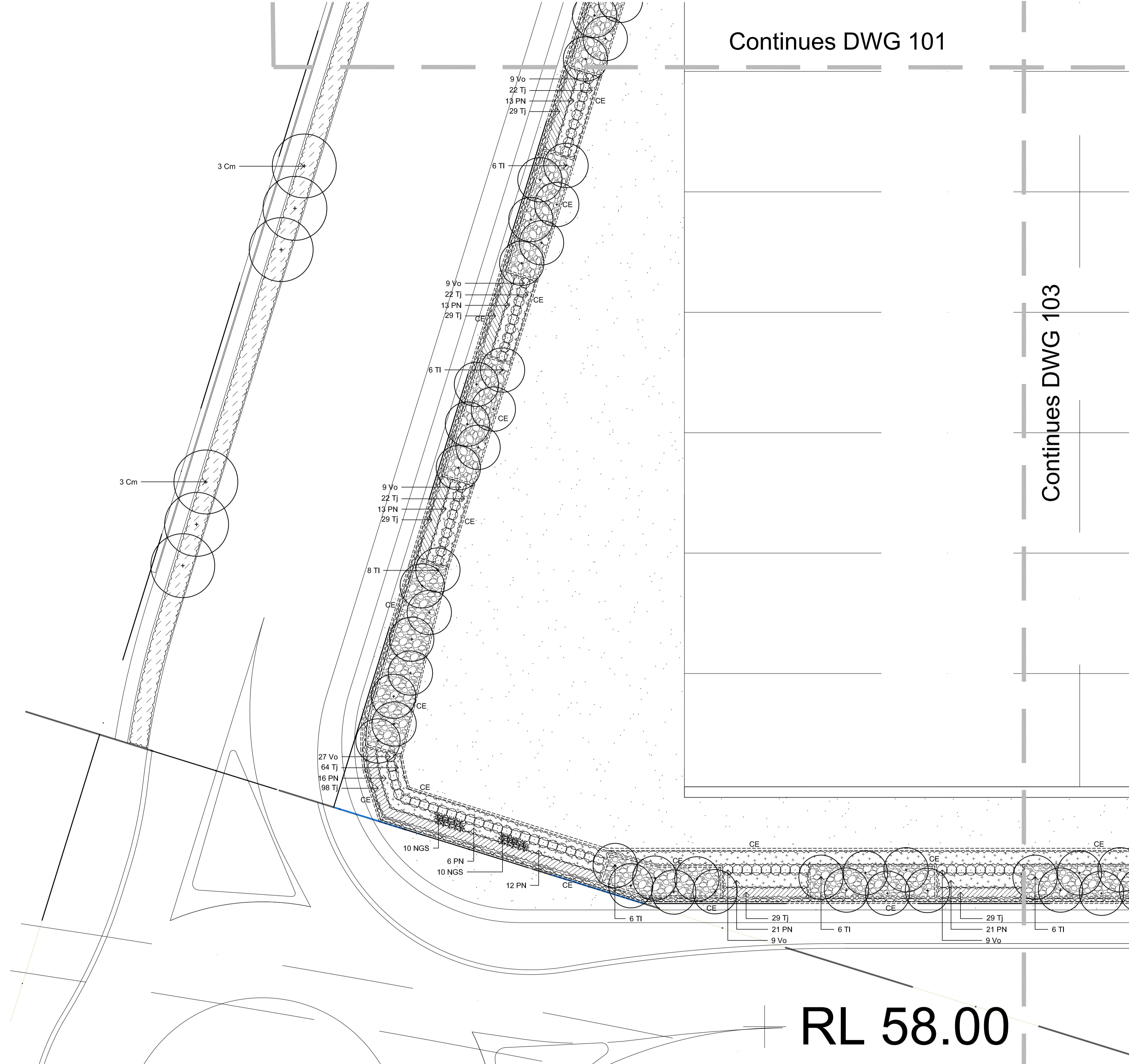

NOT FOR CONSTRUCTION

© 2014 Site Image (NSW) Pty Ltd ABN 44 801 262 380 as agent for Site Image NSW Partnership. All rights reserved. This drawing is copyright and shall not be reproduced or copied in any form or by any means (graphic, electronic or mechanical including photocopy) without the written permission of Site Image (NSW) Pty Ltd Any license, expressed or implied, to use this document for any purpose what so ever is restricted to the terms of the written agreement between Site Image (NSW) Pty Ltd and the instructing party.

The contractor shall check and verify all work on site (including work by others) before commencing the landscape installation. Any discrepancies are to be reported to the Project Manager or Landscape Architect prior to commencing work. Do not scale this drawing. Any required dimensions not shown shall be referred to the Landscape Architect for confirmation.

Issue	Revision Description	Drawn	Check	Date
B	Pump Relocation	JW	NM	31.05.2016
A	For Comment	JW	NM	27.05.2016

LEGEND	
	Property Boundary
	Proposed Trees
	Proposed Grasses and Groundcovers
	Proposed Shrubs and Accents
	Turf
	Feature Rock Ballast
	'Kwik Kerb' Concrete Edge refer specification (Not Part of these works)
	Sandstone Boulders in Decomposed Granite

Key Plan:

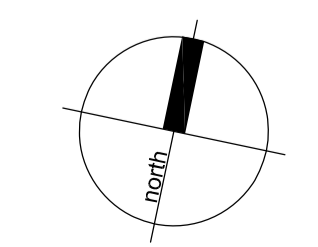

**SITE IMAGE**  
Landscape Architects  
Level 1, 3-5 Baptist Street  
Redfern NSW 2016  
Australia  
Tel: (61 2) 8332 5600  
Fax: (61 2) 9698 2877  
www.siteimage.com.au

Client:  
**Goodman**

Project:  
**Proposed Industrial Facility  
Oakdale Central Lot 3D  
Horsely Park, NSW**

Drawing Name:  
**Landscape Plan**

Scale: 1:200 @ A1  
Job Number:  
**SS13-2656**

**TENDER**

0 1 2 4 6 10m  
Drawing Number: Issue:  
**102 A**

Continues DWG 101

Continues DWG 102

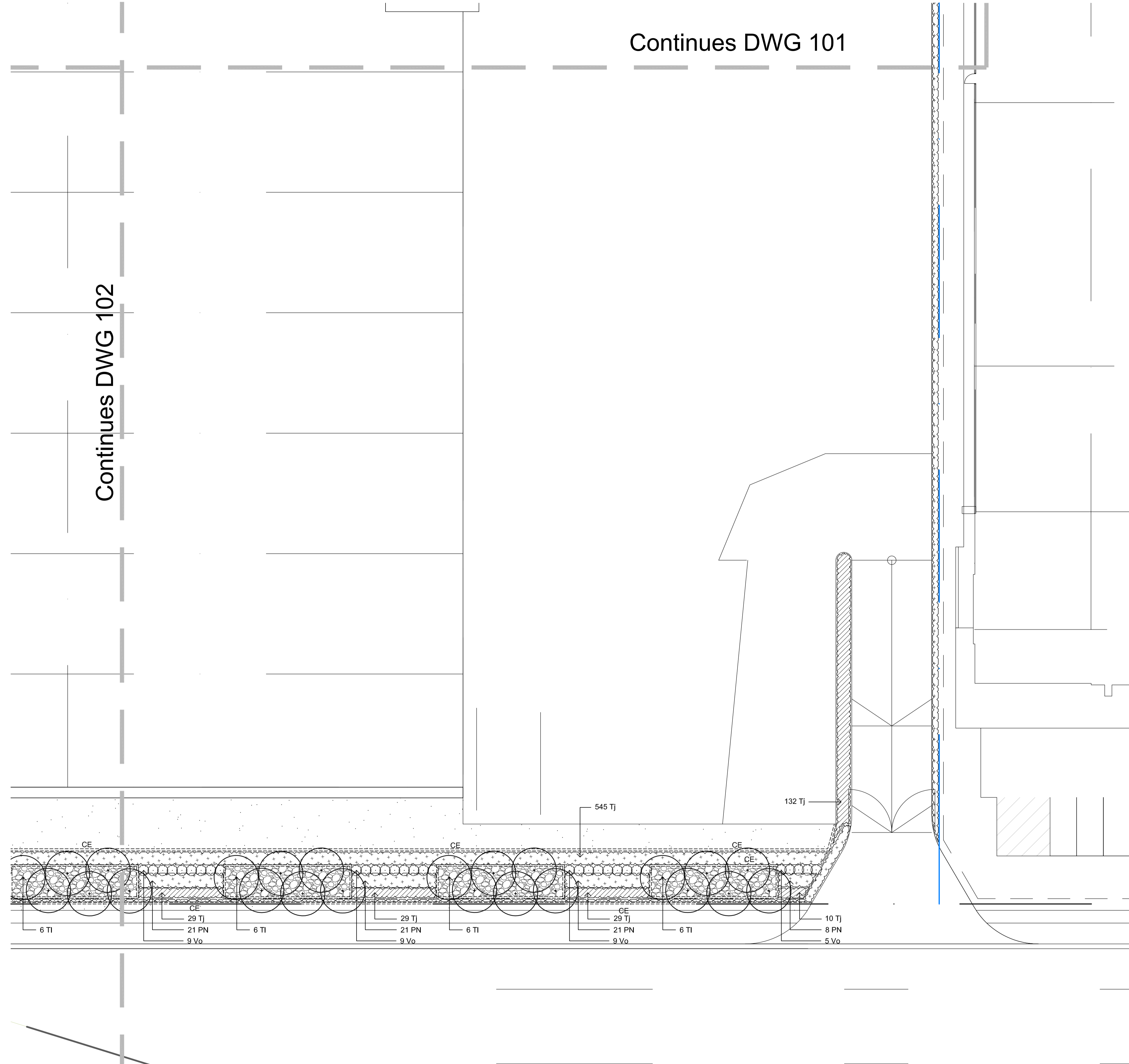





NOT FOR CONSTRUCTION

© 2014 Site Image (NSW) Pty Ltd ABN 44 801 262 380 as agent for Site Image NSW Partnership. All rights reserved. This drawing is copyright and shall not be reproduced or copied in any form or by any means (graphic, electronic or mechanical including photocopy) without the written permission of Site Image (NSW) Pty Ltd. Any license, expressed or implied, to use this document for any purpose what so ever is restricted to the terms of the written agreement between Site Image (NSW) Pty Ltd and the instructing party.

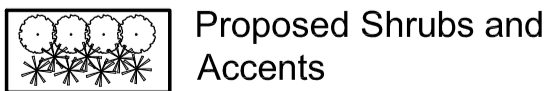
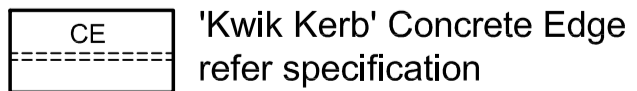
The contractor shall check and verify all work on site (including work by others) before commencing the landscape installation. Any discrepancies are to be reported to the Project Manager or Landscape Architect prior to commencing work. Do not scale this drawing. Any required dimensions not shown shall be referred to the Landscape Architect for confirmation.

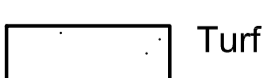
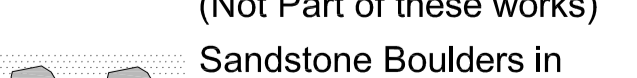
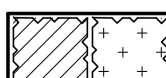
LEGEND

-  Property Boundary
-  Proposed Shrubs and Accents
-  'Kwik Kerb' Concrete Edge refer specification (Not Part of these works)
-  Proposed Trees
-  Turf
-  Sandstone Boulders in Decomposed Granite
-  Proposed Grasses and Groundcovers
-  Feature Rock Ballast

Key Plan:

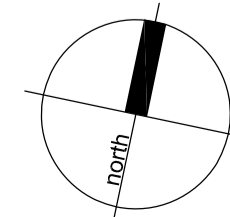

SITE IMAGE



Landscape Architects  
Level 1, 3-5 Baptist Street  
Redfern NSW 2016  
Australia  
Tel: (61 2) 8332 5600  
Fax: (61 2) 9698 2877  
www.siteimage.com.au

Client:

Goodman

Project:

Proposed Industrial Facility  
Oakdale Central Lot 3D  
Horsely Park, NSW

Drawing Name:

Landscape Plan

Scale: 1:200 @ A1

Job Number:

SS13-2656

TENDER

0 1 2 4 6 10m  
Drawing Number: Issue:

103 A

PLANT SCHEDULE							
Symbol	Botanical Name	Common Name	Mature Height (m.)	Mature Spread (m.)	Spacings	Pot Size	Quantity
<b>Trees</b>							
Ca	<i>Cupaniopsis anacardioides</i>	Tuckeroo	10	5	As Shown	75L	3
Cm	<i>Corymbia maculata</i>	Spotted Gum	20	8	As Shown	45L	15
Tl	<i>Tristaniopsis laurina</i> 'Luscious'	Water Gum	9	8	As Shown	75L	98
<b>Shrubs</b>							
NGS	<i>Nandina 'Gulf Stream'</i>	Dwarf nandina	0.5	0.5	As Shown	200mm	20
Vo	<i>Viburnum odoratissimum</i>	Sweet Viburnum	5	3.5	As Shown	300mm	172
<b>Groundcovers / Grasses</b>							
Gt	<i>Gazania tomentosa</i>	Silver Leaf Gazania	0.15	1	3/m2	150mm	106
PN	<i>Pennisetum 'Nafray'</i>	Nafray Pennisetum	0.6	0.6	2/m2	Tube	1003
Tj	<i>Trachelospermum jasminoides</i>	Star Jasmine	0.2	0.5	4/m2	150mm	2037

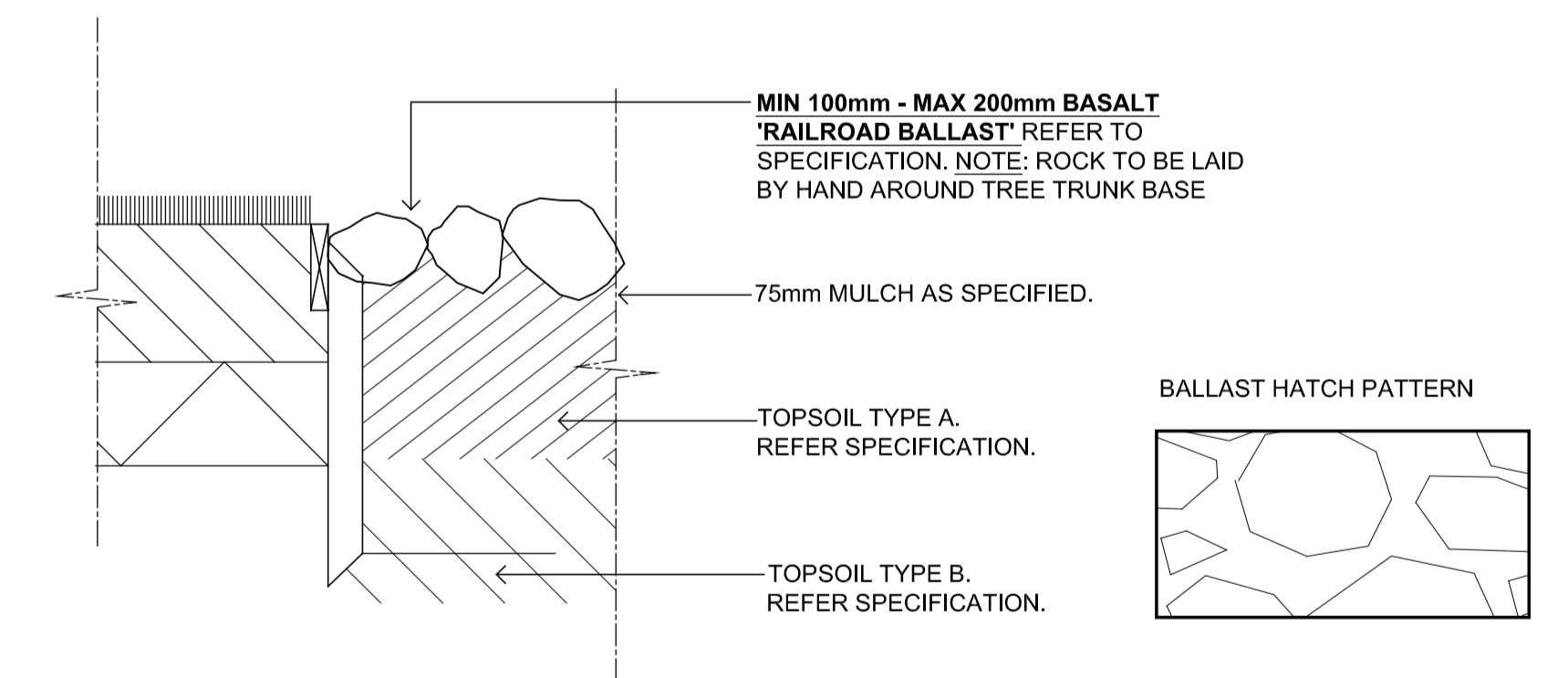
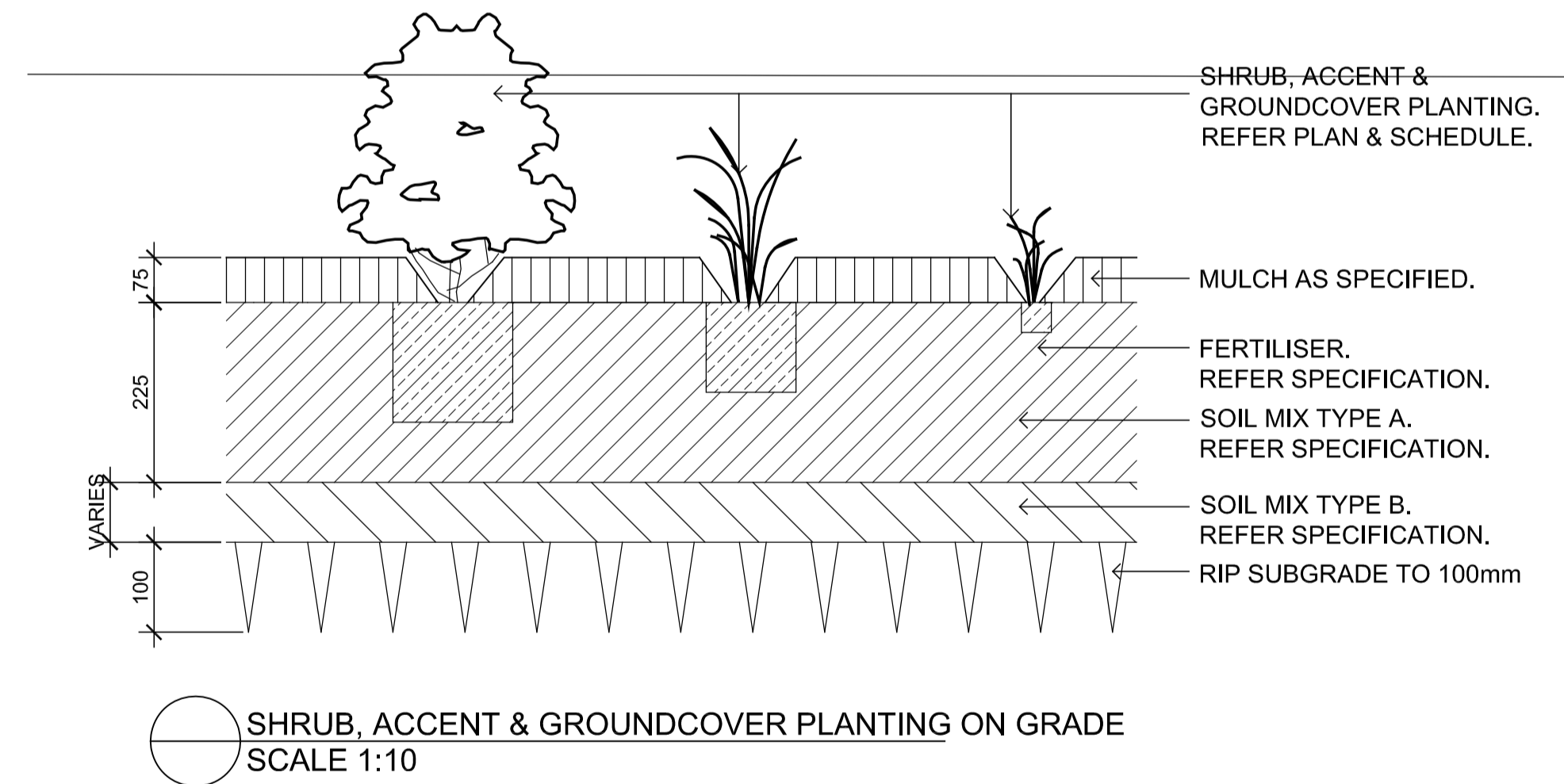
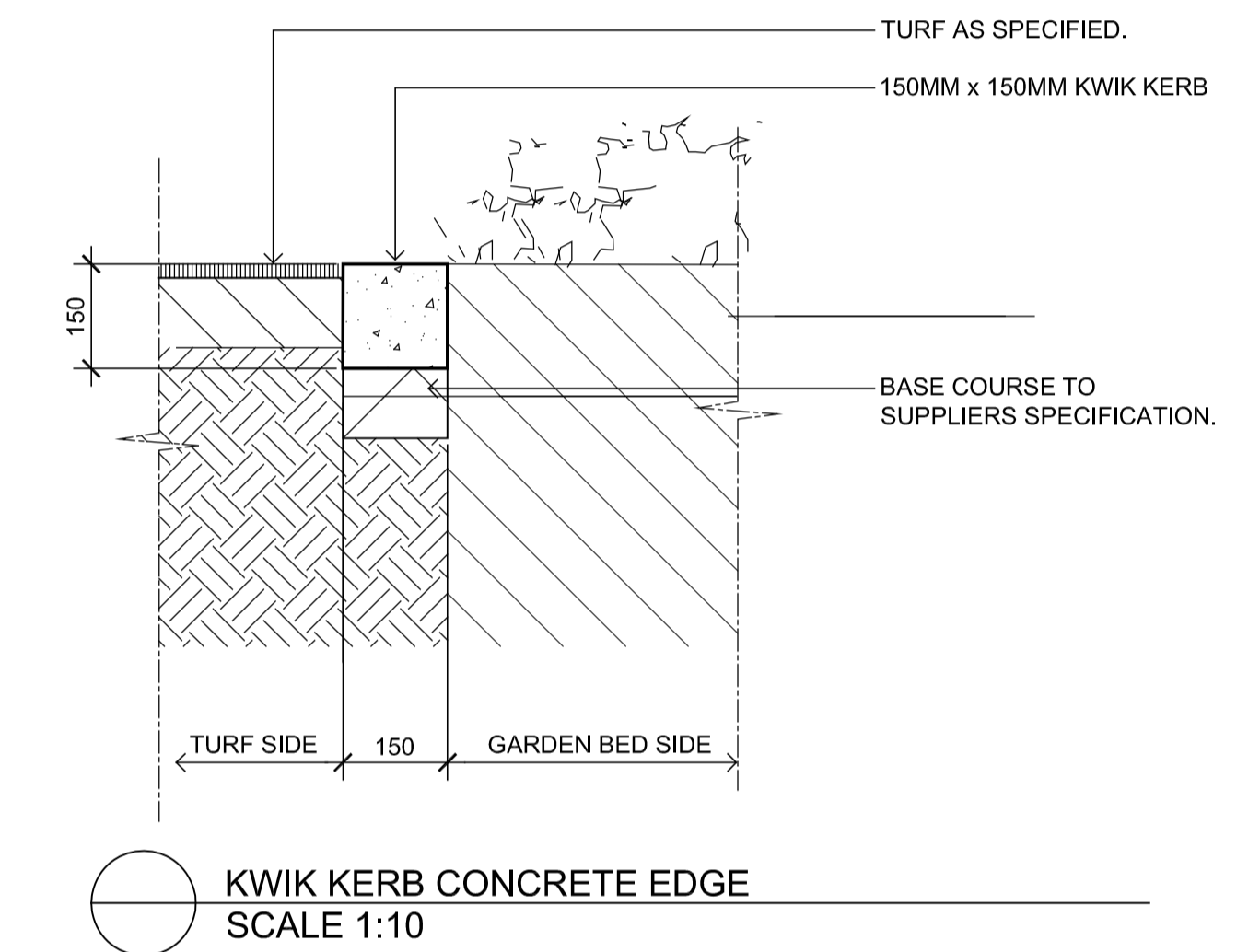
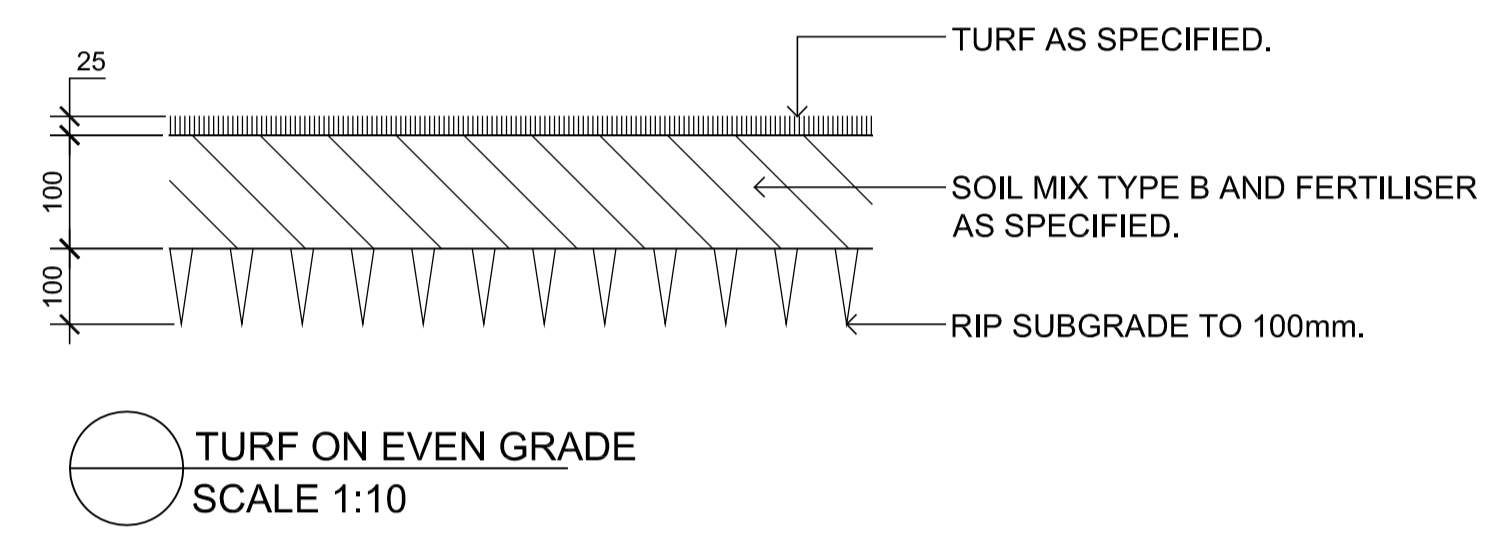
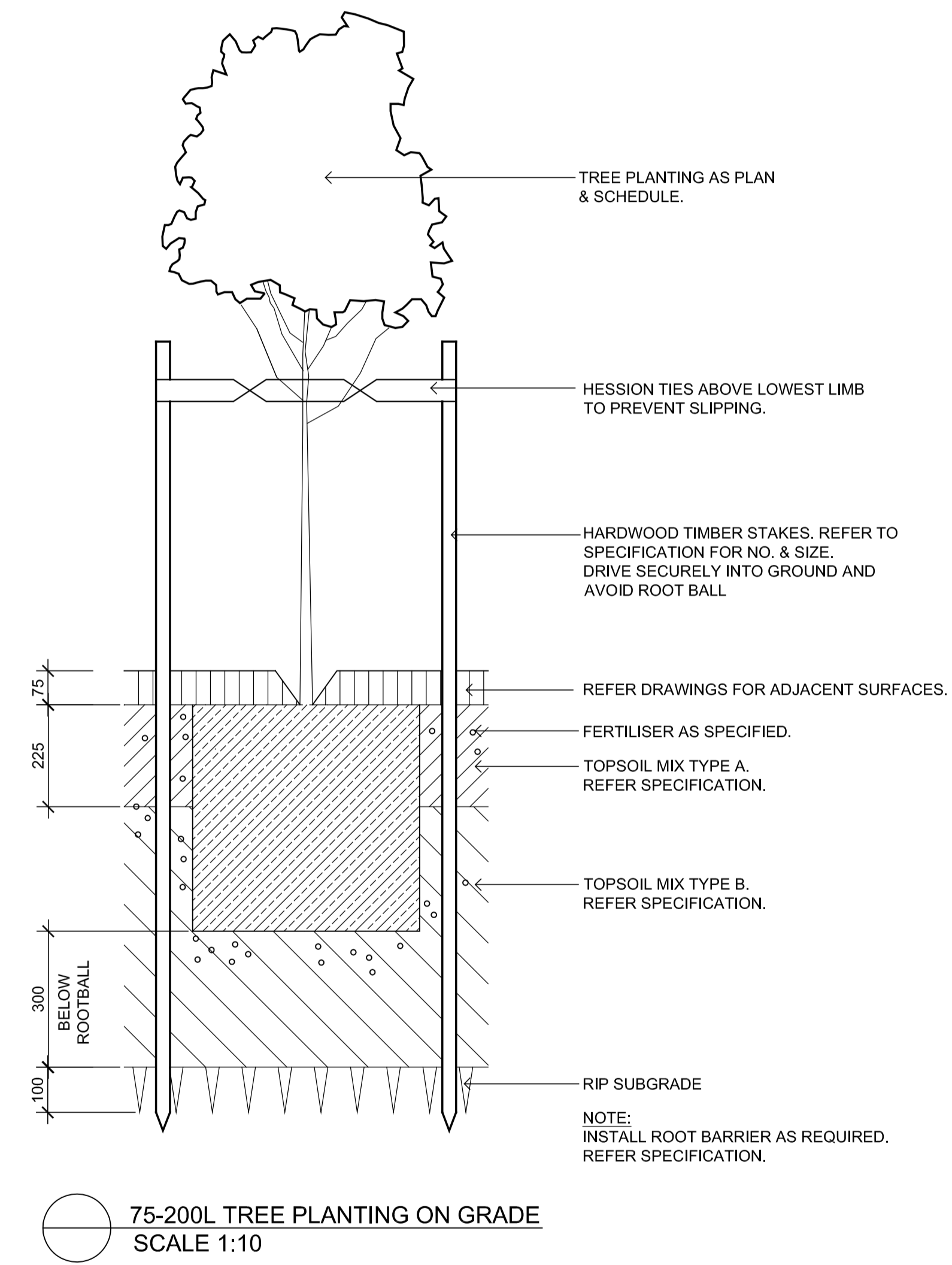
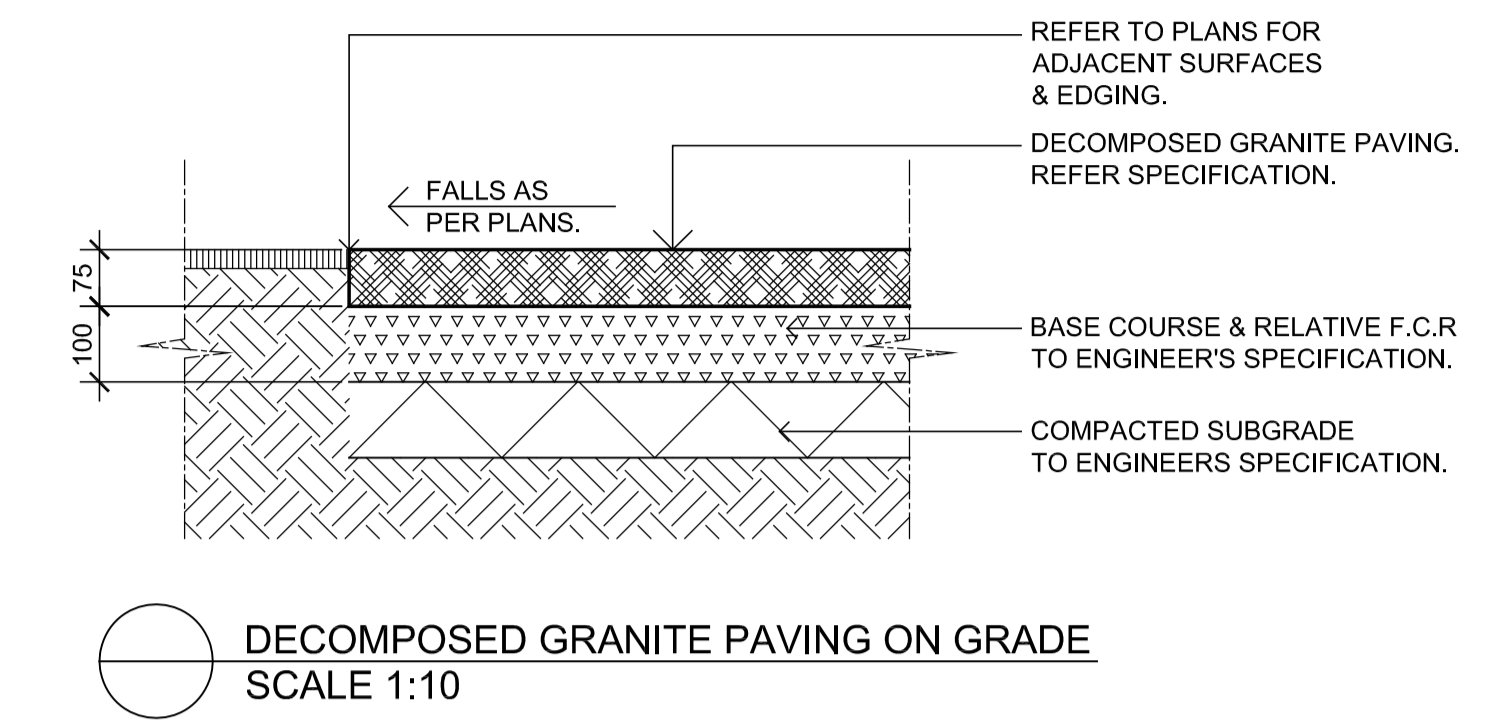

**NOT FOR CONSTRUCTION**

© 2014 Site Image (NSW) Pty Ltd ABN 44 801 262 380 as agent for Site Image NSW Partnership. All rights reserved. This drawing is copyright and shall not be reproduced or copied in any form or by any means (graphic, electronic or mechanical including photocopy) without the written permission of Site Image (NSW) Pty Ltd Any license, expressed or implied, to use this document for any purpose what so ever is restricted to the terms of the written agreement between Site Image (NSW) Pty Ltd and the instructing party.

The contractor shall check and verify all work on site (including work by others) before commencing the landscape installation. Any discrepancies are to be reported to the Project Manager or Landscape Architect prior to commencing work. Do not scale this drawing. Any required dimensions not shown shall be referred to the Landscape Architect for confirmation.

Issue	Revision Description	Drawn	Check	Date
B	Plant Species Adjusted	JW	NM	01.06.2016
A	For Comment	JW	NM	27.05.2016

LEGEND

Key Plan:

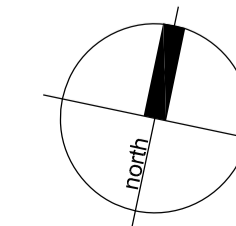

**SITE IMAGE**  
Landscape Architects  
Level 1, 3-5 Baptist Street  
Redfern NSW 2016  
Australia  
Tel: (61 2) 8332 5600  
Fax: (61 2) 9698 2877  
www.siteimage.com.au

Client:  
**Goodman**

Project:  
**Proposed Industrial Facility**  
**Oakdale Central Lot 3D**  
**Horsely Park, NSW**

Drawing Name:  
**Landscape Details**

Job Number:  
**SS13-2656**

**TENDER**