



Centennial Coal



Air Quality and Greenhouse Gas Management Plan

Western Region

April 2021

Table of Contents

1	INTRODUCTION.....	1
1.1	COMMITMENT AND POLICY	1
1.2	OBJECTIVES.....	1
1.3	EMS INTEGRATION.....	1
1.4	MANAGEMENT PLAN APPROACH	2
1.5	SCOPE.....	2
1.6	SITE OPERATIONS	2
1.6.1	<i>Airly Mine</i>	2
1.6.2	<i>Angus Place Colliery</i>	3
1.6.3	<i>Clarence Colliery</i>	3
1.6.4	<i>Lidsdale Siding</i>	3
1.6.5	<i>Springvale Mine</i>	3
1.6.6	<i>Western Coal Services</i>	4
1.7	APPROVALS AND LICENSING REQUIREMENTS	6
1.7.1	<i>Development Consents and Planning Approvals</i>	6
1.7.2	<i>Environmental Protection Licences</i>	6
1.7.3	<i>Mining Leases</i>	7
1.8	PERFORMANCE CRITERIA, LIMITS AND GOALS	8
1.8.1	<i>Air quality</i>	8
1.8.2	<i>Greenhouse Gas</i>	9
2	EXISTING ENVIRONMENT	10
2.1	METEOROLOGY.....	10
2.2	SENSITIVE RECEIVERS.....	10
2.3	BASELINE DUST LEVELS	10
2.4	BASELINE GHG LEVELS	11
3	MANAGEMENT MEASURES	12
3.1	“COMMON MEASURES”	12
3.1.1	<i>Air quality</i>	12
3.1.2	<i>Greenhouse Gas</i>	14
3.2	PROACTIVE PLANNING	15
3.2.1	<i>Air quality</i>	15
3.2.2	<i>Greenhouse Gas</i>	15
4	MONITORING PROGRAM	16
4.1	OBJECTIVE	16

4.2	MONITORING STANDARDS.....	16
4.3	MONITORING METHODS	16
4.3.1	<i>Real time dust monitoring</i>	17
4.3.2	<i>Long term dust monitoring</i>	17
4.3.3	<i>Meteorological monitoring</i>	18
4.4	MONITORING DEVICES.....	18
4.4.1	<i>Dust deposition gauges</i>	18
4.4.2	<i>Continuous particle monitors</i>	21
4.4.3	<i>High volume samplers</i>	21
4.4.4	<i>Meteorology stations</i>	22
4.4.5	<i>Equipment calibration</i>	26
4.5	MONITORING PROGRAM SUMMARY	30
4.6	REPORTING	34
4.6.1	<i>Annual Review</i>	34
4.6.2	<i>Annual Return</i>	34
4.6.3	<i>NGER reporting</i>	34
4.6.4	<i>Sustainability reporting</i>	35
4.6.5	<i>Monthly website environmental monitoring report</i>	35
4.6.6	<i>Community Consultative Committee</i>	35
5	CONTINGENCY MEASURES	36
5.1	MANAGING UNPREDICTED IMPACTS	36
5.2	TRIGGER ACTION RESPONSE PLANS.....	37
6	INCIDENTS, COMPLAINTS AND EXCEEDANCES	42
6.1	INCIDENTS.....	42
6.2	COMMUNITY ENQUIRIES OR COMPLAINTS.....	42
6.3	NON-COMPLIANCE NOTIFICATION PROCEDURE	43
7	ROLES AND RESPONSIBILITIES	43
8	TRAINING.....	46
8.1	INDUCTION TRAINING	46
8.2	TARGETED ENVIRONMENTAL TRAINING	46
8.3	ENVIRONMENTAL TRAINING COMPETENCE	46
9	MANAGEMENT PLAN REVIEW	47
9.1	REVIEW FOLLOWING AN ENVIRONMENTAL AUDIT	47
9.2	REVIEW FOLLOWING NON COMPLIANCE	47
9.3	EVENT BASED REVIEW.....	47

List of Figures

FIGURE 1 - REGIONAL SCALE SITE LOCATION MAP	5
FIGURE 2 - CENTENNIAL GHG MANAGEMENT SYSTEM FRAMEWORK	14
FIGURE 3 - TYPICAL DUST DEPOSITION STAND WITH GAUGE	20
FIGURE 4 - SHORT TERM DUST MONITORING – REGIONAL OVERVIEW	32
FIGURE 5 - LONG TERM DUST MONITORING – REGIONAL OVERVIEW	33
FIGURE 6 - PROCEDURE FOR UNEXPECTED AIR QUALITY IMPACTS	37
FIGURE 7 - PROCEDURE FOR AIR QUALITY EXCEEDANCE	43

List of Tables

TABLE 1-1 - DEVELOPMENT CONSENTS/PLANNING APPROVALS	6
TABLE 1-2 - ENVIRONMENTAL PROTECTION LICENCES	7
TABLE 1-3 - MINING LEASES AND EXPLORATION LICENCES AND MINERAL AUTHORITIES	7
TABLE 1-4 - AIR QUALITY CRITERIA	8
TABLE 3-1 - COMMON AIR QUALITY MANAGEMENT AND MITIGATION MEASURES	13
TABLE 4-1 - COMPONENT SPECIFICATIONS FOR AN AWS	22
TABLE 4-2 - MONITORING EQUIPMENT CALIBRATION REQUIREMENTS	26
TABLE 4-3 - SHORT TERM DUST MONITORING SUMMARY – WESTERN REGION	31
TABLE 4-4 - LONG TERM DUST MONITORING SUMMARY – WESTERN REGION	31
TABLE 5-1 - TARP – AIR QUALITY	38

Appendices

Appendix A – Airly Mine

Appendix B – Angus Place Colliery

Appendix C – Clarence Colliery

Appendix D – Lidsdale Siding

Appendix E – Springvale Mine

Appendix F – Western Coal Services

Appendix G – Landownership Plans

Appendix H – Consultation Log

Appendix I – Consultation Feedback and Response

DOCUMENT CONTROL

DOCUMENT DETAILS	Name:	Western Region Air Quality and Greenhouse Gas Management Plan	
	Author:	Tristan Gribble - GHD	
	Revision No.:	4	
	Document Status	Final	
APPROVAL DETAILS	Revision No.	Trigger	Details of change
	1	SSD 5594 Approval	
	2	SSD 5581 Approval	Inclusion of Airly
	3	SSD 5579 MOD 2 Approval	Administrative amendments
	4	MP 06_0021 MOD 6 Approval	Change to air quality criteria and other administrative amendments

Abbreviations

AQGHGMP	Air Quality and Greenhouse Gas Management Plan
CCC	Community Consultative Committee
CCL	Consolidated Coal Lease
CO₂	Carbon dioxide
CO_{2e}	Carbon dioxide equivalent
DPIE	NSW Department of Planning, Industry and Environment
EIS	Environmental Impact Statement
EPA	Environment Protection Authority
EPL	Environment Protection Licence
EMS	Environmental Management System
GHG	Greenhouse Gas
LGA	Local Government Area
ML	Mining Lease
Mtpa	Million Tonnes per Annum
NGER	National Greenhouse and Energy Reporting Act 2007
NSW	New South Wales
PM	Particulate Matter
PM₁₀	Particulate Matter with an equivalent aerodynamic diameter of 10 microns (one millionth of a metre) or less
PM_{2.5}	Particulate Matter with an equivalent aerodynamic diameter of 2.5 microns (one millionth of a metre) or less
POEO Act	Protection of the Environment Operations Act 1997
ROM	Run of Mine
TEOM	Tapered Element Oscillating Microbalance
TSP	Total Suspended Particulate matter
µg/m³	micrograms (one millionth of a gram) per cubic metre

1 Introduction

1.1 Commitment and policy

Centennial Coal Company (Centennial) is a coal mining company supplying thermal and coking coal to the domestic and export markets. Centennial is a major fuel supplier to the New South Wales (NSW) energy industry, fuelling approximately 40% of the State's coal-fired electricity.

Centennial is one of the largest underground coal producers in NSW and, as part of Banpu, a member of the largest independent pan-Asian coal group. Centennial's western region operations, located in the Lithgow and Mid-Western Local Government Areas (LGAs), include:

- Airly Mine;
- Angus Place Colliery;
- Clarence Colliery;
- Lidsdale Siding;
- Springvale Mine; and
- Western Coal Services.

1.2 Objectives

The purpose of this Air Quality and Greenhouse Gas Management Plan (AQGHGMP) is to ensure that operational air quality impacts on the local community are minimised, appropriate management measures identified and response protocols detailed should air quality criteria be exceeded. This AQGHGMP has been developed to:

- Address the conditions of approval for the western region operations in relation to air quality and greenhouse gas.
- Identify air quality impact pathways from Centennial operations in the western region.
- Provide a description of air quality management measures implemented across these operations.
- Outline air quality monitoring requirements and standards.
- Provide a procedure to manage and respond to complaints relating to air quality or a measured air quality incident.

1.3 EMS integration

This AQGHGMP is part of the Environmental Management Strategy (EMS) that has been developed for each operation.

1.4 Management plan approach

Air quality and greenhouse gas emissions from Centennial's operations within the western region have, historically, been individually managed. A 'regional' approach has been adopted in preparation of this AQGHGMP. The aims of adopting a regional approach to the management and monitoring of air and greenhouse gas emissions include the following:

- Provide consistent and consolidated management measures and procedures across all sites.
- Management of 'airshed' emissions, rather than focusing on individual operations.
- Rationalise monitoring procedures and locations with consideration of 'airshed' emissions.

A 'short term' and 'long term' approach has also been adopted, acknowledging that some changes will take time and require discussions and approval from the relevant authorities. The short term plans would be implemented immediately, with a transitional period for some operations to achieve the long term approach.

The AQGHGMP outlines the management and monitoring measures that will be implemented at all operations. Specific requirements for each operation are provided in **Appendix A** to **Appendix F**.

1.5 Scope

This AQGHGMP has been prepared in accordance with the respective operations conditions of approval and requirements of the sites Environmental Protection Licence (EPL) to manage air quality impacts to private receivers and the wider environment from mining operations and associated mining related activities within Centennial's western region.

1.6 Site operations

Figure 1 shows the location of each operation within the western region. The six operations within the western region have been considered as three sub-regions, based on their spatial spread and proximity to each other. The operations in each sub-region are:

- Airly Mine;
- Clarence Colliery; and
- Angus Place Colliery, Springvale Mine, Lidsdale Siding and Western Coal Services.

A brief overview of each operation within Centennial's western region is provided in the sub-sections below.

1.6.1 Airly Mine

Airly Mine is an underground coal mine located approximately 40 kilometres north-northwest of Lithgow and approximately 171 kilometres northwest of Sydney. The Mine's CoA allows extraction of 1.8 million tonnes of coal per annum for supply to both domestic and international markets by rail. The key infrastructure at the Airly Mine surface facilities area comprises administration buildings,

bathroom, workshop, coal handling infrastructure, mine ventilation infrastructure, a rail loop and train loading facilities.

1.6.2 Angus Place Colliery

Angus Place Colliery is an underground coal mine located approximately 15 kilometres to the northwest of Lithgow and approximately 120 kilometres west-northwest of Sydney. Angus Place Colliery commenced production in 1979, after being developed as an extension of the Newcom Mine at Kerosene Vale. Current approvals for the mine authorise the extraction of up to four million tonnes of coal per annum using a combination of continuous miner and longwall mining methods. The key infrastructure at the Angus Place surface facilities area comprises administration buildings, bathroom, workshop, mine ventilation infrastructure and coal handling infrastructure. Coal is transported by haul road to Mt Piper Power Station for domestic use.

1.6.3 Clarence Colliery

Clarence Colliery is an underground coal mine located approximately 10 kilometres east of Lithgow and approximately 100 kilometres west-northwest of Sydney. Clarence Colliery is a partial pillar extraction mine that commenced operations in 1979. Clarence Colliery has existing development approvals in place enabling extraction of up to three million tonnes of coal per annum for supply to both domestic and international markets by rail. The infrastructure at the Clarence Colliery surface facilities area comprises administration buildings, bathroom, workshop, mine ventilation infrastructure, coal handling infrastructure, a rail loop and train loading facilities.

1.6.4 Lidsdale Siding

The Lidsdale Siding Rail Loading Facility is located approximately 12 kilometres northwest of Lithgow and approximately 120 kilometres west of Sydney adjacent to the township of Wallerawang.

The principal components of Lidsdale Siding are a rail siding, an overland conveyor which delivers coal from the Centennial Coal Western Coal Services site, coal stockpiles, workshop, office and pollution control dams.

Lidsdale Siding handles thermal coal for distribution to domestic and international markets via the Main Western Railway Line to port facilities on the NSW coast.

1.6.5 Springvale Mine

Springvale Mine is an underground coal mine located approximately 15 kilometres to the northwest of Lithgow and approximately 120 kilometres west-northwest of Sydney. Underground coal mining commenced at Springvale Mine in 1995. Springvale Mine has existing development approvals in place enabling extraction of up to 5.5 million tonnes of coal per annum for supply to both domestic and international markets by rail. The main components of Springvale Mine's operations are an underground longwall mine, accessed via the Springvale pit top, and supporting surface infrastructure within the pit top area and on Newnes Plateau within the Newnes State Forest. The key components

of the Springvale surface facilities area comprise administration buildings, bathhouse, workshop, mine ventilation infrastructure and coal handling infrastructure.

1.6.6 Western Coal Services

The Western Coal Services operation comprises the haul roads between Angus Place Colliery and Mount Piper Power Station, an over land conveyor linking Springvale Coal Mine to Mt Piper Power Station, a washery and the Kerosene Vale Coal Stockpile Area. The Western Coal Services site receives coal from both the Springvale and Angus Place Collieries, and sends washed and run of mine coal to customers via Lidsdale Siding.

Western Coal Services has existing development approvals in place enabling up to 9.5 million tonnes of coal to be received per annum and up to seven million tonnes for ROM coal to be processed per annum.

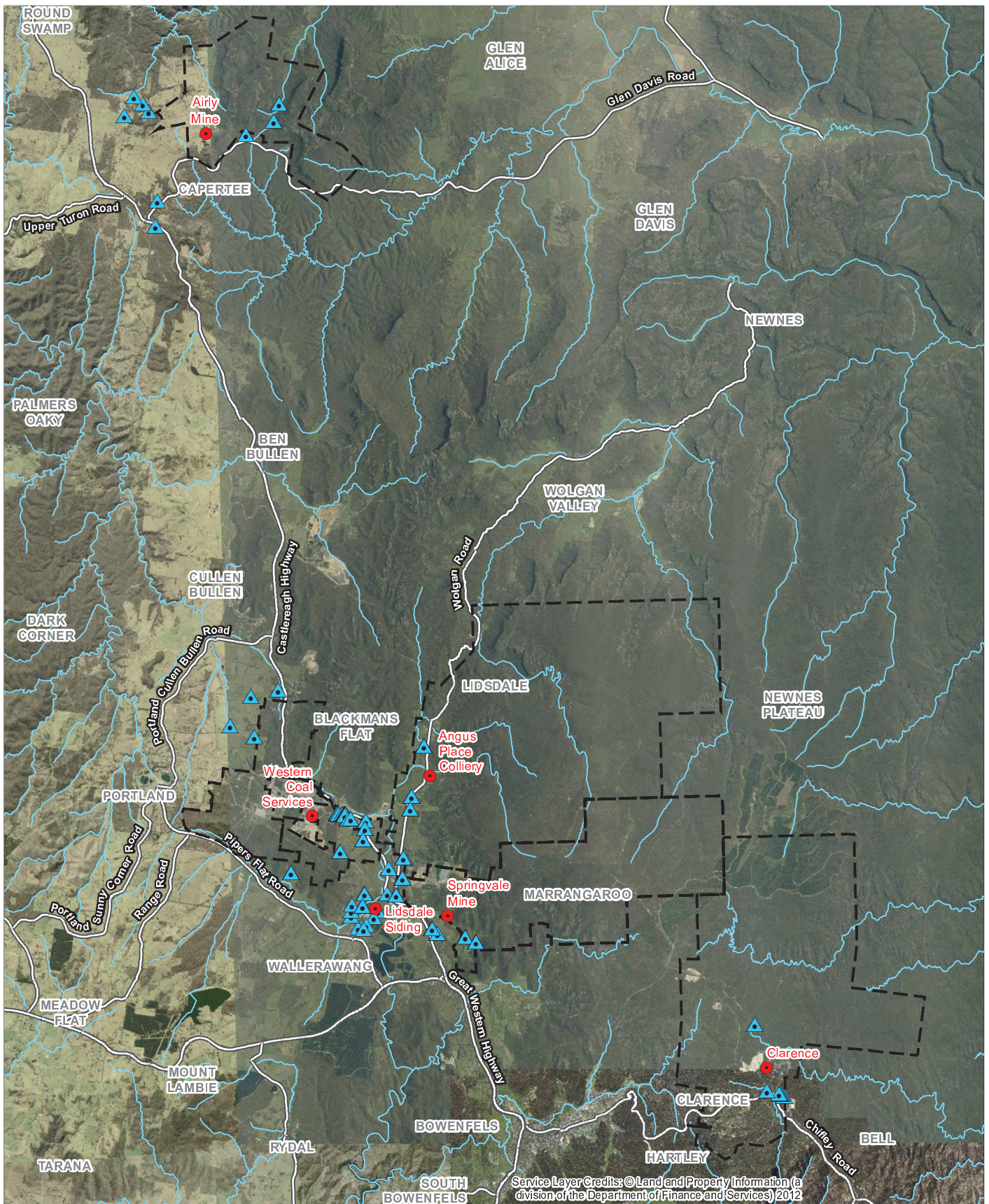

Service Layer Credits: © Land and Property Information (a division of the Department of Finance and Services) 2012

<p>1:215,000 for A4</p> <p>Kilometres</p> <p>Map Projection: Universal Transverse Mercator Horizontal Datum: Geodetic Datum of Australia 1994 Grid: Map Grid of Australia, Zone 56</p>	<p>N</p>		<p>LEGEND</p> <ul style="list-style-type: none"> ● Centennial Site Location Colliery Holding Boundary Watercourse Sensitive receiver Roads
--	----------	--	---

© 2016. Whilst every care has been taken to prepare this map, GHD, NSW Office of Water and ESRI make no representations or warranties about its accuracy, reliability, completeness or suitability for any particular purpose and cannot accept liability and responsibility of any kind (whether in contract, tort or otherwise) for any expenses, losses, damages and/or costs (including indirect or consequential damages) which are or may be incurred by any party as a result of the map being inaccurate, incomplete or unsuitable in any way and for any reason.	<p>LOCATION -</p> <p>SEAM NA</p> <p>DRAWN F.Mackay</p> <p>CHECKED T.G</p> <p>APPROVED LH</p> <p>SCALE Refer to scalebar</p>
---	---

Centennial Western Region
Environmental Monitoring

Operation Locations and
Sensitive Receivers

	<p>Centennial Coal</p>
<p>DATE 14/01/2016</p>	<p>Figure 1</p>

1.7 Approvals and licensing requirements

Centennial conducts its operations in accordance with relevant legislation and regulatory requirements. Legislative and regulatory requirements are generally recognised through the imposition of conditions of approval and various licences or mining approvals.

Centennial operates under a number of different approvals including:

- Conditions of approval issued by the Department of Planning, Industry & Environment (DPIE);
- Environmental Protection Licence (EPL) issued by the NSW Environment Protection Authority (EPA);
- A Mining Operations Plan (MOP) approved by the Resources Regulator; and
- Mining tenements issued by the Resources Regulator.

1.7.1 Development Consents and Planning Approvals

A summary of the relevant Development Consents for each respective western operation is listed in **Table 1-1**.

Table 1-1 - Development Consents/Planning Approvals

Site	Development Consent/Planning Approval ID
Angus Place	MP 06_0021
Airly	SSD 12_5581
Clarence	DA 504-00
Lidsdale Siding	MP 08_0223
Springvale	SSD 5594
Western Coal Services	SSD 12_5579

1.7.2 Environmental Protection Licences

A summary of the relevant EPLs for each respective western operation is listed in **Table 1-2**.

Table 1-2 - Environmental Protection Licences

Site	EPL ID
Angus Place	EPL 467
Airly	EPL 12374
Clarence	EPL 726
Lidsdale Siding	EPL 5129
Springvale	EPL 3607
Western Coal Services	EPL 21229

1.7.3 Mining Leases

A summary of the relevant Mining Leases and Exploration Licences for each respective western operation is listed in **Table 1-3**.

Table 1-3 - Mining Leases and Exploration Licences and Mineral Authorities

Site	ML/EL and Mineral Authority ID
Angus Place	CCL704, ML1424, ML1699, CCL756, EL6856, EL7415, EL8188, EL6293, EL5899, EL6294
Airly	ML1331, A232
Clarence	ML1583, CCL705, ML1353, ML1354, A416, EL5072, A451
Lidsdale Siding	MPL314
Springvale	ML1588, CL377, ML1323, ML1303, ML1326, ML1670, ML1537, ML1727, MPL314, A460 and EL6974
Western Coal Services	ML1448, ML1319, ML1352, CCL733

1.8 Performance criteria, limits and goals

Air quality and GHG performance criteria are provided in the Development Consent for each operation.

1.8.1 Air quality

The same air quality criteria apply across all operations in the western region consistent with the National Environment Protection (Ambient Air Quality) Measure (NEPM) and *Approved Methods for the Modelling and Assessment of Air Pollutants in New South Wales* (Dec 2005).

The desired outcomes of the NEPM goals are for “ambient air quality that allows for the adequate protection of human health and well-being”. The ambient air quality NEPM has been developed for the protection of human health. Whilst exceedence of these levels may not lead to unacceptable health outcomes (as reflected in the PM₁₀ standard itself, which allows for five exceedences per year), it is appropriate that the NEPM standards be used as a platform for developing regulatory limits and management targets.

The air quality criteria contained within the various Development Consents are shown below. As noted above the same criteria applies to all operations:

The Applicant shall ensure that all reasonable and feasible avoidance and mitigation measures are employed so that particulate matter emissions generated by the development do not cause exceedances of the criteria at any residence on privately-owned land.

Table 1-4 - Air quality criteria

Pollutant	Averaging period	Criteria
Particulate Matter < 10 µm (PM ₁₀)	Annual	^{a,d} 30 µg/m ³ / 25 µg/m ³
Particulate Matter < 10 µm (PM ₁₀)	24 hour	^{a,e} 50 µg/m ³
Total suspended particulates (TSP)	Annual	^{a,d} 90 µg/m ³
^c Deposited dust	Annual	^b 2 g/m ² /month above background ^{a,d} 4 g/m ² /month cumulative

Notes to **Table 1-4**:

a Cumulative impact (i.e. increase in concentrations due to the development plus background concentrations due to all other sources).

b Incremental impact (i.e. increase in concentrations due to the development alone, with zero allowable exceedances of the criteria over the life of the development).

c Deposited dust is to be assessed as insoluble solids as defined by Standards Australia, AS/NZS 3580.10.1:2003: Methods for Sampling and Analysis of Ambient Air - Determination of Particulate Matter - Deposited Matter - Gravimetric Method.

d Excludes extraordinary events such as bushfires, prescribed burning, dust storms, fire incidents or any other activity agreed by the Secretary.

e. Schedule 2 of the NEPM allows for exceedance of the PM₁₀ 24-hour goal for a maximum of 5 days per year.

1.8.2 Greenhouse Gas

The legislative framework for Greenhouse and Energy reporting is the:

- *National Greenhouse and Energy Reporting Act 2007*
- *National Greenhouse and Energy Reporting Regulations 2008; and*
- *National Greenhouse and Energy Reporting (Measurement) Determination 2008 (as amended).*

The National Greenhouse and Energy Reporting Act 2007 (NGER Act) introduced a single national framework for reporting and providing company information regarding greenhouse gas emissions, energy production and energy consumption. The NGER Measurement Determination (as amended) was made under the NGER Act to provide for the measurement of greenhouse gas emissions arising from the operation of facilities and the energy production and energy consumption arising from the operation of facilities.

The objectives of the NGER Act are to:

- inform government policy
- inform the Australian public
- help meet Australia's international reporting obligations
- assist Commonwealth, state and territory government programs and activities, and
- avoid duplication of similar reporting requirements in the states and territories.

Centennial is the 'Controlling Corporation' and exceeds the controlling corporation emissions threshold (50,000 CO_{2e}T) and therefore is required to report its greenhouse gas (GHG) emissions, energy used and produced from all facilities in accordance with the NGER Act (see Section 4.6.3).

2 Existing environment

2.1 Meteorology

The geographical area of the western region operations is within a 'temperate' climatic zone. Sub-classes of the climatic classification avoid a 'hot summer' (primarily due to elevation) and are a mixture of 'warm summer' classes with either 'no dry season' or 'moderately dry winter'.

While the western region operations straddle the Great Dividing Range, the Newnes Plateau provides some protection from weather systems originating from the east. However, The Great Dividing Ranges themselves are capable of generating enhancement of rain (convective thunderstorm) activity. Average monthly rainfall total and number of rain days are remarkably consistent throughout the annual cycle, at ~70 mm and 7-8 days respectively. Summer rain events can be heavier due to enhanced convective activity and result in these months having slightly higher monthly rainfall averages than the rest of the year.

Winter westerly winds are a dominate feature as the sub-tropical ridge migrates to the north before spending a greater time to the south for the warmer months. Local winds associated with funnelling through valley systems produces local effects that mask the more regional to synoptic scale weather patterns.

2.2 Sensitive receivers

Sensitive receivers within the western region predominantly consist of residential properties. Other sensitive receivers include recreational areas within the Newnes Plateau.

Isolated rural residential properties are scattered around all operations within the western region, as shown in **Figure 1**. More urbanised residential properties are concentrated in areas such as Blackmans Flat.

A detailed map of residential properties surrounding each operation within the western region is provided in each site appendix – **Appendix A to Appendix F**.

2.3 Baseline dust levels

Dust monitoring has been undertaken by Centennial in the western region operations for many years. Long term trends in deposited dust have been established around all operations, inclusive of background reference levels.

Baseline dust levels are measured to provide an indication of regional 'airshed' dust levels, without direct impact from mining operations. Results from dust gauges located to measure impacts from mining operations can then be compared to baseline dust levels in order to determine the incremental impact from mining operations. Baseline dust gauges are typically located upwind from a mine or separated from operations in order to minimise the impact from local mining operations.

Dust monitoring sites that have been established to specifically monitor background/baseline dust levels are detailed in the individual site appendices.

2.4 Baseline GHG levels

The Australian Government introduced the Emissions Reduction Fund in December 2014. It comprises three elements:

- Crediting – incorporating identification of potential emission reductions and estimate them using approved “methods” (additional to business- as-usual).
- Purchasing – sell these credits at auctions.
- Safeguard Mechanism – to ensure that reduction paid for through the crediting and purchasing elements of the ERF are not displaced by increases above Business as usual (BAU) elsewhere in the economy.

The safeguard mechanism applies to facilities with scope 1 (direct) emissions of >100,000 CO_{2e}T per annum. All of the western region operations are well below the safeguard application threshold and therefore will not in the foreseeable future meet the safeguard mechanism baseline requirements.

The safeguard mechanism will commence on 1 July 2016 and will require those facilities that meet the threshold to keep emissions within baseline levels. Simple baselines will be set at the highest level of reported emissions for a facility over the historical period 2009-10 to 2013-14.

Multi-year monitoring will allow a facility to exceed its baseline in one year, so long as average emissions over two or three years are below the baseline. A process for new investments and expansions also exists under the scheme.

The Safeguard Mechanism will be reviewed in 2017. Centennial will monitor the outcomes of the review to identify any management response that may be required.

3 Management measures

Dust is a generic term used to describe fine particles that are suspended in the atmosphere. Deposited dust refers to any dust that falls out of suspension from the atmosphere. Activities that have been identified as possible sources of dust emissions are:

- Wind erosion from coal stockpiles;
- Wind erosion from disturbed areas and non-coal stockpiles;
- Wheel generated dust from vehicle movements;
- Fugitive emissions from coal handling and processing;
- Fugitive emissions through mine ventilation fans as a result of underground mining operations;
- Rail loading operations;
- Coal transporting activities (conveyor, truck, rail); and
- Operation of mobile equipment.

The sections below outline the air quality management measures which are ‘common’ across all operations within the western region operations.

Air quality management or mitigation measures which are specifically required at individual operations that are not addressed in these common measures are provided in **Appendix A** to **Appendix F**.

3.1 “Common measures”

3.1.1 Air quality

The measures outlined in **Table 3-1** are currently being implemented to minimise to the greatest extent practicable emissions to air. These measures are implemented across all operations, where applicable. Following industry-leading practice, these are a mixture of routine design and operational controls. Any operation-specific measures are provided in the relevant appendix.

Table 3-1 - Common air quality management and mitigation measures

Emission source	Emission type	Control measure
Unsealed roads	Dust	<ul style="list-style-type: none"> • Use of water carts to dampen trafficable areas. • Truck speeds restricted to 40 km/hour.
Coal stockpiles	Dust	<ul style="list-style-type: none"> • Use of water cannons/water sprays on coal stockpile, as required.
Train loading operations	Dust	<ul style="list-style-type: none"> • The use of an automatic train loader which produces a low and even profile of coal on the surface of the wagon and reduces spillages. • Transporting coal with a high inherent moisture content.
Overland Conveyors	Dust	<ul style="list-style-type: none"> • A combination of partial and fully enclosed conveyors and conveyor transfer points.
Mobile Equipment	Exhaust emissions	<ul style="list-style-type: none"> • Regular maintenance of plant and equipment in accordance with the manufacturer's specifications to ensure optimal operating conditions.
Ventilation fans	Dust, Exhaust emissions	<ul style="list-style-type: none"> • Use of low sulfur diesel and diesel engines that conform to the United States EPA Tier 3 standards for exhaust emissions. • Implementation of an underground dust suppression system involving the use of water sprays on coal cutting machinery and rubber conveyor belts.
Disturbance Areas	Dust	<ul style="list-style-type: none"> • Timely rehabilitation of disturbed areas wherever practical
Truck haulage	Dust, Exhaust emissions	<ul style="list-style-type: none"> • All haulage trucks entering and leaving the sites have their loads covered. • Use of low sulfur diesel in coal haulage trucks.

3.1.2 Greenhouse Gas

The following measures are currently being implemented to minimise to the greatest extent practicable GHG emissions.

An Energy and Greenhouse Management System monitors and reports energy usage. Key Performance Indicators that are tracked include energy demand and GHG emissions per tonne of ROM coal produced.

Additional measures that are implemented include:

- cost effective measures to improve energy efficiency;
- regular maintenance of plant and equipment to minimise fuel consumption; and
- consideration of energy efficiency in plant and equipment selection.

Centennial has been investigating greenhouse emission reduction options for a number of years. Greenhouse emissions arise from our operations from the use of energy (fuel and electricity) and the release of dilute methane gas from ventilation fans to the atmosphere known as Ventilation Air Methane (VAM).

Centennial has a Climate Change Management Strategy and System that aims to achieve the Climate Change Policy objectives.

The overall Strategy is to:

- Minimise emissions at least cost; and
- Maximise the value from beneficial reuse of gas.

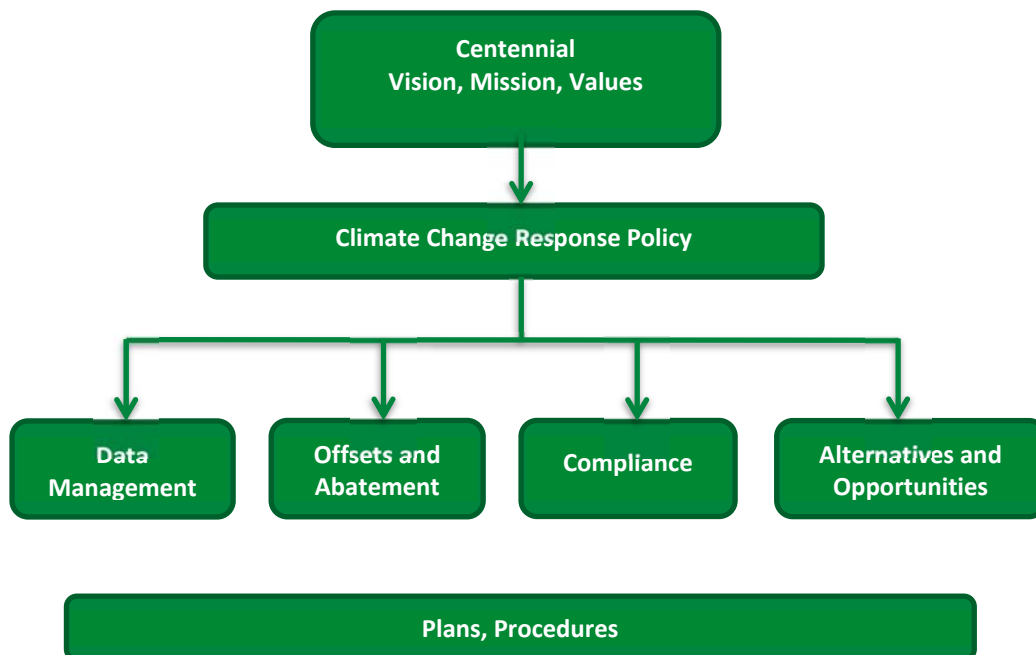

Figure 2 - Centennial GHG management system framework

3.2 Proactive planning

3.2.1 Air quality

A number of measures are implemented to proactively plan and manage air quality emissions from the western region operations. Measures implemented by Centennial include:

- A region-wide monitoring rationalisation to make more use of real-time dust monitoring to provide more informative data and enable more timely response to incidents.
- Regular (annual) reviews of monitoring and management measures.
- Impact assessments of future changes/expansions.
- Pollution Reduction Programs.

3.2.2 Greenhouse Gas

As part of Centennial's Sustainability Strategy, Centennial has set its "Vision 2020", the platform to tangibly deliver the Company Vision and Values. Vision 2020 incorporates a target for GHG, being to reduce our greenhouse gas emissions by 25% by 2020. An action plan and roadmap is in place to deliver this goal.

4 Monitoring program

4.1 Objective

The objective of the dust monitoring programme is to provide data, both real time and long term (trend data), to identify the dust impact and to assist with the identification and management of dust emissions from Centennial's western region operations.

Dust monitoring enables Centennial to assess compliance with the legislative and regulatory requirements.

The results of the monitoring programme will be used to review and improve Centennial's operational dust management practices.

4.2 Monitoring standards

Dust monitoring is undertaken in accordance with the following standards:

- AS/NZS 3580.1.1:2007 Methods for sampling and analysis of ambient air – Guide to siting air monitoring equipment.
- AS/NZS 3580.10.1:2003 Methods for sampling and analysis of ambient air - Determination of particulate matter - Deposited matter - Gravimetric method.
- AS/NZS 3580.9.3:2015 Methods for sampling and analysis of ambient air - Determination of suspended particulate matter - Total suspended particulate matter (TSP) - High volume sampler gravimetric method.
- AS/NZS 3580.9.6:2015 Methods for sampling and analysis of ambient air - Determination of suspended particulate matter – PM10 high volume sampler with size selective inlet – Gravimetric method
- AS/NZS 3580.9.8-2008 Methods for sampling and analysis of ambient air - Determination of suspended particulate matter - PM10 continuous direct mass method using a tapered element oscillating microbalance analyser.
- AS/NZS 3580.9.11:2008 Methods for sampling and analysis of ambient air - Determination of suspended particulate matter – PM10 beta attenuation monitors.

Meteorological monitoring is undertaken in accordance with the following standard:

- AS/NZS 3580.14:2014 Methods for sampling and analysis of ambient air - Meteorological monitoring for ambient air quality monitoring applications.

NATA accredited laboratories are used for analysis of field samples.

4.3 Monitoring methods

Dust monitoring is undertaken to assist in quantifying the impact of dust from operations and assess incremental and cumulative dust levels against regulatory requirements. Monitoring is typically

undertaken nearby site boundaries, at sensitive receiver (i.e. residence) locations, or at a representative location on the transect between the source and receptor.

Off-site dust monitoring locations are selected based on those sensitive receivers predicted to have the highest level of impact (typically based on predictive modelling from impact assessment reports).

The sections below outline the types of dust monitoring utilised by Centennial.

4.3.1 Real time dust monitoring

Real time dust monitoring allows instantaneous feedback of dust concentrations at the monitoring site. Real time feedback can allow for immediate ameliorative action to be taken if elevated dust levels are recorded and linked back to a source that can be 'managed'.

Real time monitoring is used to guide the level of dust mitigation and management implemented on site.

4.3.2 Long term dust monitoring

Long-term amenity and health impact dust impacts (over annual average) are measured using a combination of dust deposition gauges (measuring dust fall-out) and high volume air sampling (TSP/PM₁₀) typically operated on a 1-in-6 day cycle.

Deposited dust is an indicator of the effectiveness of site dust management practices and the potential for off-site dust nuisance. Deposited dust is typically monitored in a number of locations around the site. Monitoring is conducted with dust deposition gauges that should be located both upwind and downwind of the activity area to reflect the impact of the operations during the most predominant wind directions. A more remote (from the site) dust deposition gauge(s) can be deployed to ascertain the regional (non-local, mine impacted) background levels.

Results of monitoring should not exceed 4 g/m²/month and/or no more than 2 g/m²/month above background as a rolling annual average (average of the previous 12 months). When using a network of monitors, the lowest recorded monthly value is taken to be the background (this may well be the 'background' site or the most upwind gauge for the month). If dust levels exceed this value then site management practices should be reviewed and dust controls implemented to reduce dust levels to within these limits.

The criteria for deposited dust have been successfully used at numerous sites in New South Wales to protect the amenity of populations near landfills and quarries. The criteria in the *Approved Methods* were originally developed (and 'calibrated') using experience from coal mining operations and impacts in the Hunter Valley. Although the assessment criterion is a rolling 12-month average, the shorter-term averaging interval is set at a monthly average to enable an assessment of nuisance dust in a timely manner to ensure that people's amenity is not adversely impacted and a review of the AQHGMP. If the criteria are exceeded, management actions can be identified and implemented to reduce dust levels to avoid further nuisance being created.

High volume air sampling can measure total particles (TSP) or fine particulates (PM₁₀), depending on the sampling inlet used. The size selective inlet ensures the correct 'equivalent aerodynamic diameter' particles are captured on the filter media. Because of the high-volume nature of the inlet air

(automatic flow control set at a volumetric flow of 1.3 m³/min – range 1.0 to 1.6 m³/min – for TSP and 1.13 m³/min ±10% for PM₁₀), these samplers perform far superior to low-volume samplers. Alternative regulatory approved sampling includes a Tapered Element Oscillating Microbalance (TEOM) or Beta Attenuation Monitor (BAM) – these are particularly useful at the PM₁₀ range and to provide real-time feedback at time scales of less than 24-hour.

When assessing the regulatory requirements of daily or annual dust-in-air concentrations, the real-time nature of the measurement technique is less important – this favours high-volume sampling over TEOM or BAM.

4.3.3 Meteorological monitoring

Meteorological monitoring is used to determine prevailing regional and local weather conditions. In some situations, the monitoring can be used to guide the level of mitigation implemented on site (e.g. high winds; low rain; prevailing wind from an adverse impact direction). Historical information provides useful data in assisting in determining the source of dust (e.g. downwind/upwind) especially during the analysis of any dust events.

A standard Automatic Weather Station (AWS) used for ambient air quality purposes most often measures wind speed and direction, (dry bulb) temperature (optionally with a temperature gradient – typically 2m and 10m) and global solar radiation (optionally net radiation but this is not in the Australian Standard). Non-essential, for dust dispersion purposes, parameters included in the Australian Standard are relative humidity, atmospheric pressure and rainfall. The exposure requirements under the Australian Standards also require a minimum 10 m mast and un-feted exposure to prevailing conditions.

4.4 Monitoring devices

Dust monitoring is typically undertaken using one or more of the following devices:

- Dust deposition gauges.
- High volume air samplers.
- Low volume air samplers.
- Real-time monitors of dust in air concentrations.

The following sections provide a summary of dust monitoring devices and the standard procedures for use for Centennial operations.

4.4.1 Dust deposition gauges

Dust deposition is measured using gauges. This method measures dust deposition rate and involves the passive deposition and capture of dust within a funnel and bottle arrangement. Data is usually collected over monthly periods and results are expressed in g/m²/month (i.e. the mass of dust deposited per square metre per month – the ‘standard’ month being 30 ± 2 days).

The Australian Standard AS/NZ 3580.10.1:2003 Methods for sampling and analysis of ambient air Method 10.1: Determination of particulate matter – Deposited matter – Gravimetric method defines the measurement of deposited matter by collection in a vessel and retained (together with any rainwater over the monthly exposure period).

Dust deposition gauges are sited in accordance with AS/NZS 3580.1.1:2007 Methods for sampling and analysis of ambient air - Guide to siting equipment.

The 'vessel' in this instance is a wide mouth glass bottle of at least 4 litres. The collection funnel has a 150 mm diameter 'mouth' (with a tolerance of +/- 10 mm but measured to within the nearest mm for calculation purposes). The nominal angle of the cone sides is 60 degrees. A stopper is used to seal the funnel to the collection bottle but has a groove to allow for water overflow during excessively wet months. A sturdy stand is required to support the deposition gauge so that the funnel mouth is in a horizontal plane, with minimal 'sway' and is 2.0 +/- 0.2 m above ground level. An optional bird ring may be used if this is an issue at the site.

The monitoring sites will meet the requirements of AS/NZ 3580.1.1:2007 and ensure the key elements of:

- A clear sky cone of a minimum of 120 degrees (no tree branches for example above the gauge)
- Unrestricted airflow coming from the general area of the sources wishing to be measured (free of obstacles such as buildings, for example).

The principle of the technique is that, over a given sampling period, particles that settle from the ambient air are collected in a vessel together with any rainwater. The sampled mass deposition rate of deposited matter is calculated from the mass of solids obtained, the funnel cross-sectional area and the exposure period (i.e. one month).

An example of a dust deposition gauge is shown in **Figure 3**.

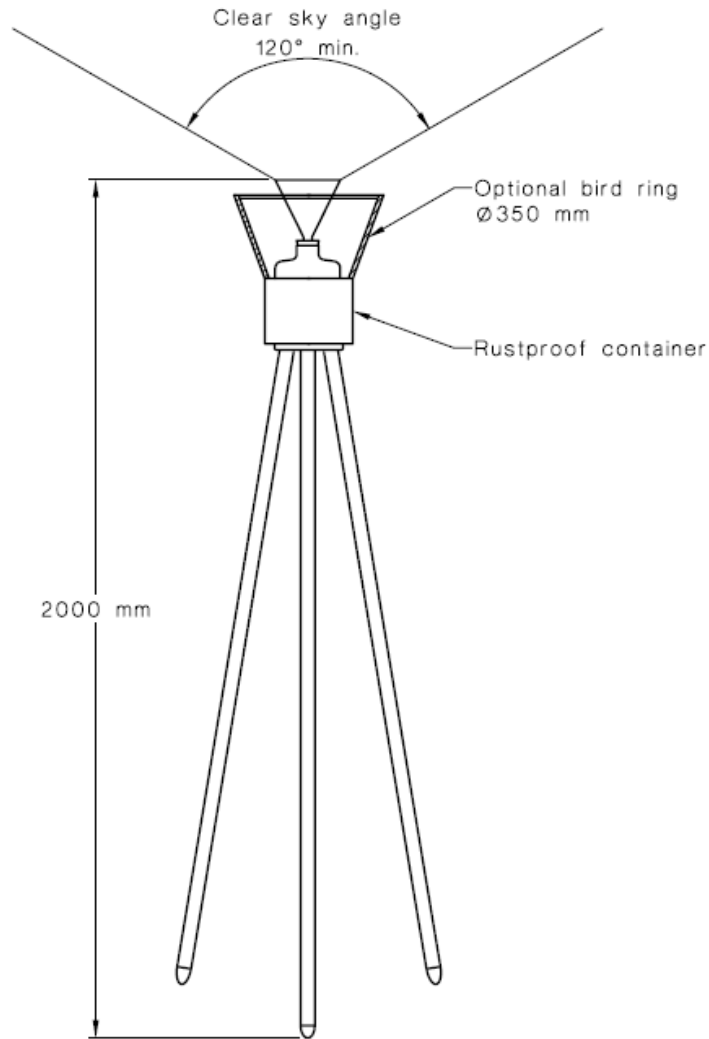

Figure 3 - Typical dust deposition stand with gauge

4.4.1.1 Monitoring procedure

Each monitoring period requires the concurrent exposure of all gauges for 30 +/- 2 days.

The following outlines the steps involved in collection of samples:

- At the end of the exposure period, remove the sample bottle and funnel from the holder.
- Wash any deposited matter adhering to the inside of the funnel into the deposit gauge bottle using a minimum volume of distilled water.
- Remove the funnel and seal the bottle with a lid. Identify the bottle with a label or ID (linked to the monitoring site, period of exposure and funnel diameter).
- With a chain of custody, deliver the bottle to a NATA registered laboratory for analysis. The analysis to include both soluble and insoluble matter.
- Insert the clean funnel into a fresh bottle and leave exposed for the next sample period.

Over time, a rolling 12-month average will be able to be calculated. These values for each gauge are required to be below 4.0 g/m²/month for insoluble dust. To satisfy the incremental impact criterion, the gauge with the lowest recorded value will be used as the indicator of 'background'. The calculation of the increase in deposited dust can then be made at the remaining gauge(s), so that any increase exceeding 2.0 g/m²/month above the adopted background is identified and that event is used as a trigger to audit the dust management practices for the site or region.

4.4.2 Continuous particle monitors

Continuous or 'real-time' particle monitors can come in various forms. These measurements rely on in-direct measurement techniques as the 'standard' approved technique of direct measurement of both mass and volume is the high-volume sampler (HVAS) but this is an integration over a (usually 24-hour ± 1-hour) time interval.

The fastest response, real-time indirect measurement can be achieved by light (or laser) scattering due to the particles in the air. The nephelometer is the only light-scattering device with an Australian Standard (3580.12.1). This instrument is rather bulky and less suited to field measurement (outside of an integrated ambient Air Quality Monitoring Station (AQMS) with bottled clean air for calibration) than more compact, compromised instruments that use light or laser over shorter path lengths (DustTrak or TES Dust Master Pro, for example). The technique is reliant on the light scattering characteristics of the particles involved and this can vary significantly with particle size and density as well as prevailing atmospheric humidity. Some on-board compensation can be achieved by sample in-let heating or reference to particle counting. Moreover, generally low-volume sampling is used for field instruments and this can restrict true sampling of all passing particles.

Regulatory approval is given to the indirect measurement techniques involving TEOM's and BAM's (oscillating frequency of mass attached to a tapered element and beta attenuation, respectively). These have had equivalence studies done to compare to the robust HVAS and are deemed to be accurate enough for sub-hourly sampling (but not as short a time frame as instantaneous light scattering). Ten to thirty minute sample intervals are enough to provide data that can be used in near real-time.

The monitor(s) may be fitted with PM₁₀ size (10 micron) selective inlets. The monitor/s can be configured to record 10-minute averages of in-air PM₁₀ concentration. A "trigger level" will be determined, an indicative level being 100 µg/m³ over a 10-minute average. These values may be 'fine-tuned' over a period of time to suit the application and site-specific characteristics. The unit/s will provide a warning via an audible or visible signal, or as a communication link (such as SMS text) when the pre-set level is triggered. If the alarm is raised, this would be a trigger to identify the source of dust generation and implement additional dust control measures immediately.

4.4.3 High volume samplers

HVAS draw precise volumes of air through a filter paper of known weight for a set period of time. Filter papers are then re-weighed so the particulate loading of the air (in mg/m³) can be calculated. The paper contents can also be examined and analysed for characteristics of the mass collected – such as metal content).

HVAS draw precise volumes of air through a filter paper. The filter paper is weighed before and after the exposure period to calculate the quantity of particulates collected in a measured mass (this can then be converted to $\mu\text{g}/\text{m}^3$ by knowing the volume of air sampled over the exposure period). The exposure period under AS3580.9.3:2015 is 24 hours every 6 days. The HVAS can measure Total Suspended Particulates (TSP) or be fitted with a selective inlet to measure other particle sizes, such as those less than 10 microns (PM_{10}).

4.4.4 Meteorology stations

Any installed AWS must conform to the requirements of the Australian Standard AS3580.14:2014. **Table 4-1** provides the instrument types and component specifications required for fully integrated Automatic Weather Stations (AWS). Specifications are applicable only where required, as per each operations CoA.

Note that an ultrasonic anemometer may optionally be used for wind speed and direction but this is for the rarely needed situation when the contribution of small eddies is important.

Exposure (to the Australian Standard) and data logging are key considerations. A minimum of a 10 m mast is required and may be a permanent fixture or temporary/relocatable as either a telescopic aluminium type (requires guy-wires 4-5 m radius from the base of the mast) or hinged steel on a pre-installed concrete base/pad.

Table 4-1 - Component specifications for an AWS

Parameter (weather element)	Instrument	Specification
Temperature – dry bulb (DBT)	Resistance Temperature Detectors (RTD)	Two – to be place at 2 m and 10 m. Each with radiation shield. Range: -10 to 50 °C Total accuracy (at 20 °C): ± 0.1 °C Time constant: <45 s
Relative humidity	Hygrometer	In a naturally ventilated radiation shield at 2 m. Range: 5 to 100% RH Total accuracy (at <90%): ± 2 % Total accuracy (at >90%): ± 4 % Resolution: 1% Operating temperature: -10 to 55 °C

Parameter (weather element)	Instrument	Specification
Wind speed	Anemometer – mechanical device	Cups on cross-arm at 10 m Range: 0.5* to 30 m/s Total accuracy (greater of): 3% or ± 0.2 m/s Resolution: ≤ 0.25 m/s Starting threshold*: ≤ 0.4 m/s Distance constant: ≤ 3 m Maximum averaging interval: 10 min Data sampling frequency: ≤ 5 s
Wind direction	Wind Vane – mechanical device	Wind vane on cross-arm at 10 m Range: 0. to 360° (output deadband $\leq 5^\circ$) Total accuracy (excluding deadband): $\pm 3^\circ$ Resolution: 1° Starting threshold: ≤ 0.5 m/s Damping ratio: 0.25 to 0.6 Maximum averaging interval: 10 min Minimum number of data samples (Yamartino calculation better at 720 over ~15 minutes): $>360 @ 10$ min
Rain	Tipping bucket rain gauge	Able to be mounted on level ground (small concrete slab) away from main mast. Minimum Range: 0 to 400 mm/h Total accuracy: $\pm 5\%$ (0 to 120 mm/h) Minimum resolution: 0.5 mm

Parameter (weather element)	Instrument	Specification
Net radiation	Net radiometer	<p>Able to be arm mounted on mast at ~2 m (extending true north).</p> <p>Heating not required.</p> <p>Spectral range (overall): 200 nm to 100 μm</p> <p>Sensitivity: 10 $\mu\text{V}/\text{W}/\text{m}^2$</p> <p>Response time: < 20 s</p> <p>Operational temperature range: -30 $^{\circ}\text{C}$ to +70 $^{\circ}\text{C}$</p> <p>Field of view: 180$^{\circ}$ upper and lower sensor</p> <p>Non-linearity (over full range): <1 %</p>
Barometric pressure	Barometer	<p>Electronic device preferably with triple redundancy with automatic temperature compensation. Continuous direct-reading able to be data logged.</p> <p>Range: 750 to 1050 hPa</p> <p>Total accuracy: ± 3 hPa</p> <p>Resolution: 1 hPa</p> <p>Operating temperature: -10 to 55 $^{\circ}\text{C}$</p>

Parameter (weather element)	Instrument	Specification
Solar radiation	Pyranometer	<p>Preferred pyranometer is a thermopile radiometer with a silicon photovoltaic detector mounted in a fully cosine-corrected miniature head.</p> <p>Continuous direct-reading able to be data logged.</p> <p>Second class (photovoltaic) pyranometers are acceptable.</p> <p>Response time: <60 s</p> <p>Zero offset (net thermal radiation): +30 W/m²</p> <p>Zero offset (ambient temperature): ±8 W/m²</p> <p>Non-stability: ±3.0 %</p> <p>Non-linearity: ±3.0 %</p> <p>Directional response: ±30 W/m²</p> <p>Spectral sensitivity: ±10 %</p> <p>Temperature response: ±8 %</p> <p>Tilt response: ±5 %</p>
Instrument mast		<p>10 m guyed or stand-alone hinged steel.</p> <p>Able to be guyed either on vendor supplied base plate of site constructed concrete pad (2 m by 2m).</p> <p>Instrument enclosure and data logger suitably housed at 1-2 m.</p> <p>10 m cross arm for wind, Pyranometer and 10m DBT sensors.</p> <p>Lightning protection and earthed to AS/NZS 1768.</p>

Parameter (weather element)	Instrument	Specification
Data logger		Data Acquisition System Wind speed data recorded as zero when wind speed below starting threshold. Wind direction flagged as missing when wind speed below starting threshold. Able to measure and adjust for any open space in wind vane potentiometer. Scalar and vector averaging of wind speed. Standard deviations of wind speed and wind direction (sigma-theta via Yamartino).

*AS3580.14:2014 specifies a minimum of 0.5 m/s and starting threshold of 0.4 m/s, but for this application a lower threshold with robust, light-weight cups is advantageous.

4.4.5 Equipment calibration

Monitoring equipment will be maintained and calibrated on a regular basis in accordance with the relevant Australian Standard. The calibration requirements for monitoring equipment are summarised below in **Table 4-2**.

Table 4-2 - Monitoring equipment calibration requirements

Equipment	Relevant Standard	Calibration frequency	Calibration description
Dust gauge	AS/NZS 3580.10.1	-	N/A – NATA laboratory responsible for calibration of measuring equipment used.
HVAS	AS/NZS 3580.9.3 (TSP)	Various, as required	Flow calibration performed once instrument installed/relocated or following significant maintenance or repair.
	AS/NZS 3580.9.6 (PM10)	2 months	On-going recalibration of the sampler is “at intervals not exceeding two months.”

Equipment	Relevant Standard	Calibration frequency	Calibration description
		Annual	Annual check on Programmable time clock and elapsed time meter. Analytical balance instruments responsibility of NATA laboratory.
BAM	AS/NZS 3580.9.11	Quarterly	Check: Particle mass and Volumetric flow rate.
		Quarterly	Clean: Routine maintenance includes three-monthly cleaning of PM ₁₀ size selective air inlet and
		Annual	Check and clean: Leak check; Vacuum pump check; Clean air inlet system.
		Annual	Particle mass calibration; Volumetric flow rate calibration; Pressure transducer check and calibration; Temperature sensor check and calibration; Zero check.
		As required	The measurement chamber should be changed after advice from BAM manufacturer (depends on 'dustiness' of ambient conditions).
TEOM	AS/NZS 3580.9.8	6 months	Flow controller software calibration; Flow audit (main and auxiliary).
		Annual	A mass transducer calibration occurs whenever the instrument is relocated to a new site and then annually.
		Annual	Annually: Analog input/output calibration; Flow controller hardware calibration; Ambient pressure and temperature calibrations; Mass calibration verification; Zero air noise level check.

Equipment	Relevant Standard	Calibration frequency	Calibration description
Other real-time dust monitors. E.g. TES Dust Master Pro	ISO12103-1 international standards	Annual	Fully calibrated to ISO12103-1 international standards by supplier before leaving factory. Fully sealed and pre-calibrated field replaceable optics block. Annual factory calibration of replacement optical engine and two new pumps. Additionally, if the laser diode fails or the laser light level falls below a set threshold, then a new optics block is retro-fitted. 37mm filter cartridges used for periodic gravimetric sampling to calibrate site specific 'K-Factor'. A total of 6 different dust/aerosol user-stored, specific calibration factors can be easily switched to optimize measurements of different dusts on different sites/situations.
Meteorological station	AS/NZS 3580.14	As required	Wind sensor orientation to true north at installation/changeover.
		Monthly	Sensor inspection and cleaning (material deposited on the 'upward' facing surface) shall occur no longer than monthly.
		3 months	A site inspection should be conducted at an interval not exceeding three months: review recorded data; physical damage; anemometer zero check; true north alignment
		3 months	Rainfall: The tipping bucket funnel and tipping apparatus shall be checked and cleaned at an interval not exceeding three months.
		6 months	Ambient temperature: Single point <i>in situ</i> every 6 months.

Equipment	Relevant Standard	Calibration frequency	Calibration description
		6 months	<p>Relative humidity.</p> <p>Operational precision check every 6 months.</p>
		6 months	<p>Atmospheric pressure.</p> <p>Electronic barometers shall undergo an initial calibration (certificate at time of installation).</p> <p>An operational precision check shall be carried out at an interval not exceeding six months.</p> <p>This in situ single point precision test can be via using a remote barometer (nearest BoM station adjusted for height) or with a transfer standard barometer.</p>
		Annual	<p>Global solar radiation.</p> <p>Pyranometers shall undergo an initial calibration (certificate at time of installation).</p> <p>Pyranometers shall be recalibrated at an interval not exceeding 12 months. This is performed by returning the sensor to the manufacturer so just swap instruments annually.</p>
		Annual	<p>Ambient temperature: Three point annually.</p>
		Annual	<p>Relative humidity.</p> <p>Three point calibration with test atmosphere annually.</p> <p>Alternatively, swap RH probe on an annual basis with calibration certificate from supplier.</p>

Equipment	Relevant Standard	Calibration frequency	Calibration description
		Annual	Rainfall. An operational precision check upon installation and then annually (by introduction of known volumes of water at a controlled rate).
		2 years	Wind speed and direction. Once an initial calibration has been performed, wind speed and direction sensors shall be checked and recalibrated at an interval not exceeding two years.

4.5 Monitoring program summary

Centennial operate a comprehensive monitoring program in the western region involving numerous dust gauges, HVAS, real-time dust monitors and meteorological stations. This monitoring program allows Centennial to quantify dust impacts from western region operations at sensitive receiver locations for analysis and comparison of the environmental performance against relevant CoA and EPL's. The monitoring program also allows for the effectiveness of environmental management measures to be measured.

The locations of long term dust monitoring locations in relationship to landownership are shown on the plans in **Appendix G**. Where compliance dust monitoring locations are located on Centennial owned land, compliance is determined at that monitoring locations for the relevant sensitive receptors.

A Summary table of all existing dust monitoring undertaken in Centennials western region is provided in **Table 4-3** and shown on **Figure 4**. The values in **Table 4-3** represent the short-term monitoring program. The long term dust monitoring programme is summarised in **Table 4-4** and shown on **Figure 5**.

Table 4-3 - Short term dust monitoring summary – western region

Operation	Dust gauges	HVAS	Real-time monitor	Meteorology station
Airly Mine	4	-	-	1
Angus Place Colliery	8	1	-	2
Clarence Colliery	3	-	1	1
Lidsdale Siding	6	-	1	1
Springvale Mine	2	1	-	1
Western Coal Services	3	-	1	1

Table 4-4 - Long term dust monitoring summary – western region

Operation	Dust gauges	HVAS	Real-time monitor	Meteorology station
Airly Mine	4	1	0	1
Angus Place Colliery	3	1	-	2
Clarence Colliery	3	-	1	1
Lidsdale Siding	5	-	-*	1
Springvale Mine	2	-	1*	1
Western Coal Services	3	-	1	1

*The real-time monitor listed under Springvale Mine has been located to represent regional dust levels, central to Springvale Mine, Lidsdale Siding and to a lesser extent Western Coal Services and Angus Place Colliery.

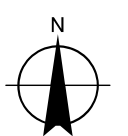
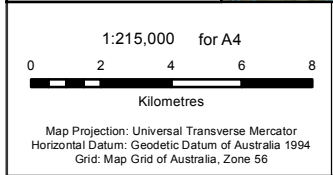
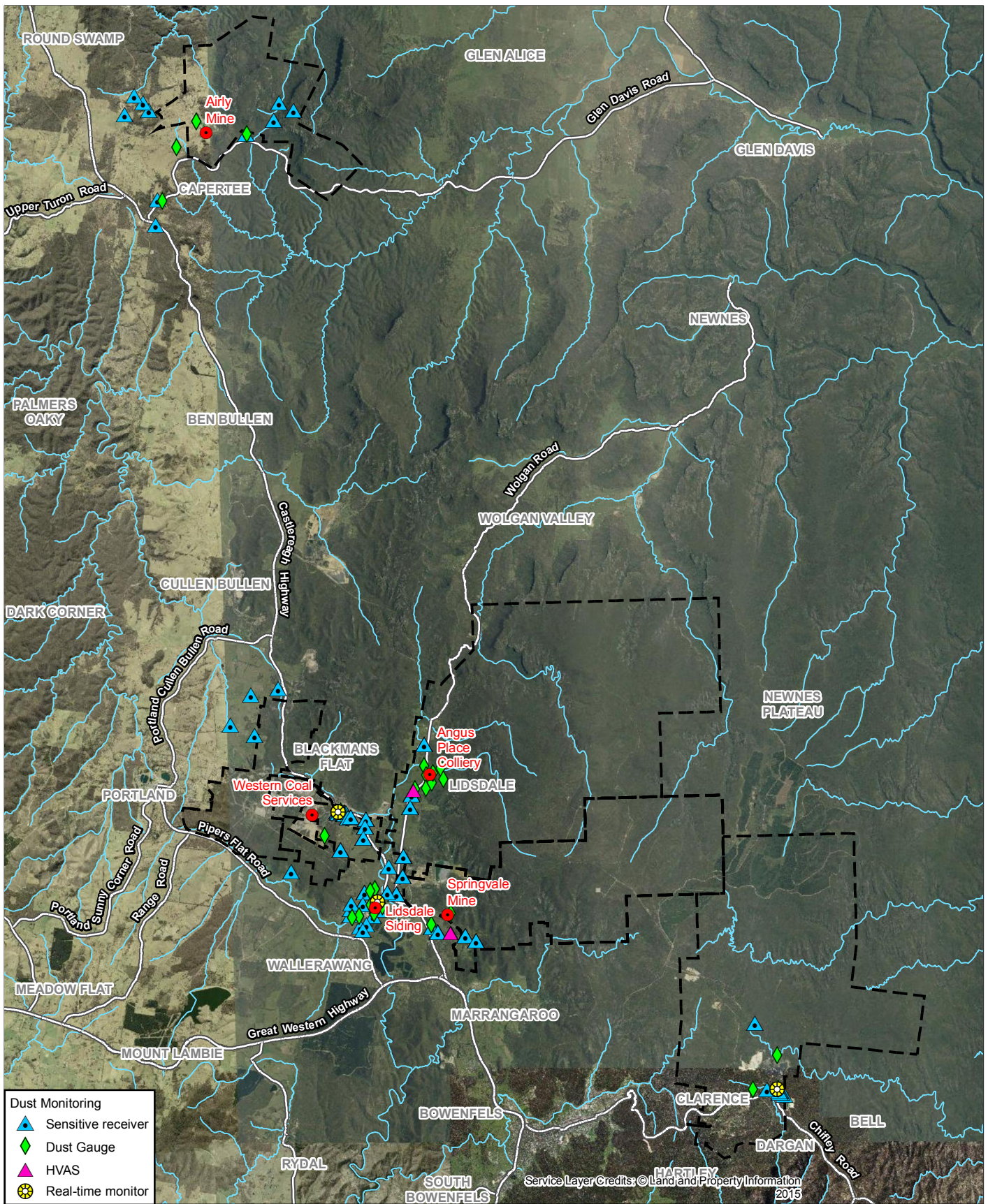

- LEGEND**
- Centennial Site Location
 - Colliery Holding Boundary
 - Watercourse
 - Roads

LOCATION	-
SEAM	NA
DRAWN	F.Mackay
CHECKED	T.G
APPROVED	LH
SCALE	Refer to scalebar

Centennial Western Region
Environmental Monitoring

Overview
Short Term Dust Monitoring

Centennial
Coal

DATE 9/03/2017	Figure 4
----------------	----------

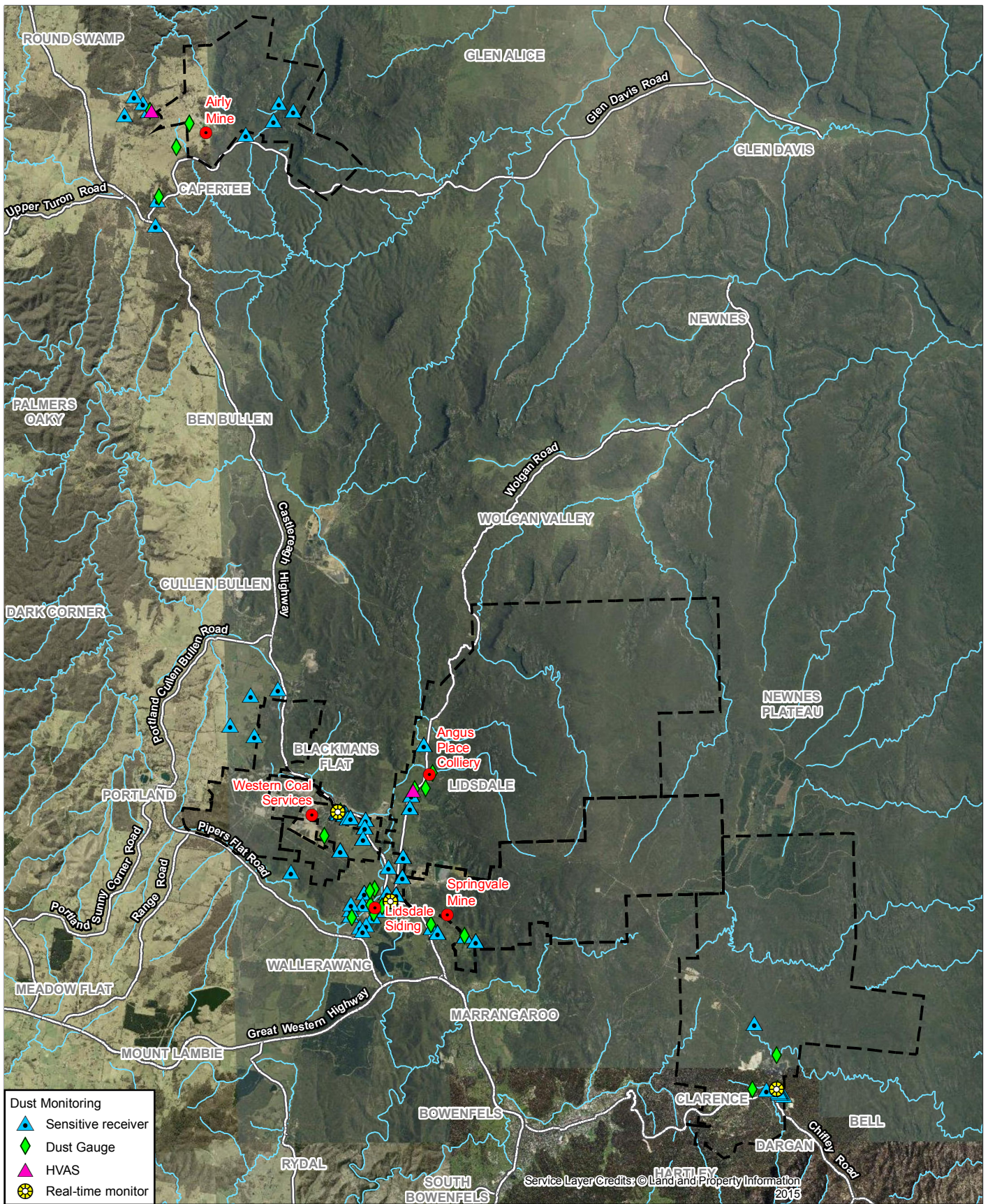

Dust Monitoring

- Sensitive receiver
- Dust Gauge
- HVAS
- Real-time monitor

1:215,000 for A4

Kilometres

Map Projection: Universal Transverse Mercator
Horizontal Datum: Geodetic Datum of Australia 1994
Grid: Map Grid of Australia, Zone 56

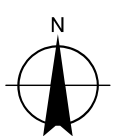

LEGEND

- Centennial Site Location
- Colliery Holding Boundary
- Watercourse
- Roads

LOCATION	-
SEAM	NA
DRAWN	F.Mackay
CHECKED	T.G
APPROVED	LH
SCALE	Refer to scalebar

**Centennial Western Region
Environmental Monitoring**

**Overview
Long Term Dust Monitoring**

**Centennial
Coal**

DATE	9/03/2017	Figure 5
------	-----------	----------

4.6 Reporting

4.6.1 Annual Review

An Annual Review is to be completed in accordance with the requirements of the conditions of approval for each operation. The Annual Review includes:

- information on the development and activities carried out in the past calendar year,
- information on the activities proposed to be carried out over the current calendar year;
- A comprehensive review of the monitoring results and complaint records of the development over the past calendar year;
- A comparison of monitoring results against:
 - the relevant statutory requirements, limits or performance measures/criteria;
 - the monitoring results of previous years; and
 - the relevant predictions in the EIS.
- Information on any non-compliances over the past year, and what actions were (or are being) taken to ensure compliance;
- An identification of any trends in the monitoring data;
- Identification of any discrepancies between the predicted and actual impacts of the development, and an analysis of the potential cause of any significant discrepancies; and
- A description of what measures will be implemented over the next calendar year to improve the environmental performance of the development.

Any dust monitoring undertaken under this management plan, that are not a requirement of the EPL are to be reported annually through the Annual Review. The Annual Review is made available on the Centennial Coal website.

4.6.2 Annual Return

An annual return stating the sites compliance with the conditions of its EPL is completed and submitted to the EPA on an annual basis. This is done in compliance with the EPL conditions and by the due date as stated in the EPL.

4.6.3 NGER reporting

Centennial exceeds the controlling corporation emissions threshold (50,000 CO_{2e}T) and therefore is required to report its greenhouse gas (GHG) emissions, energy used and produced from all facilities in accordance with the NGER Act. This is termed a NGER section 19 Energy and Emissions Report (NGER Report) and is submitted to the Clean Energy Regulator (CER). The NGER Report includes all of the greenhouse emissions from each facility under the operational control of entities of Centennial. GHG emissions are calculated from input data from facilities (mine sites, support services, offices). These

emissions are reported as Scope 1 (direct) and Scope 2 (indirect), giving rise to total GHG emissions, energy consumed and energy produced for each financial year reporting period.

The NGER Report requires submission by 31 October each year.

The CER is required to publish this data on its website.

4.6.4 Sustainability reporting

The progress towards Vision 2020 will be monitored by the Sustainability Steering Committee and reported in the annual published Sustainability Report.

4.6.5 Monthly website environmental monitoring report

A monitoring report is published on the website to satisfy the requirements under the Protection of the Environment Legislation Amendment Act 2011 (POELA Act) to publish or make pollution monitoring data available to members of the public.

4.6.6 Community Consultative Committee

The Community Consultative Committee (CCC) meets on a regular basis. Some of the information reported at the CCC includes:

- operational issues;
- monitoring and environmental performance; and
- community complaints and the response to complaints.

5 Contingency measures

5.1 Managing unpredicted impacts

Unpredicted air quality impacts may include such things as:

- Observed dust plumes moving off-site.
- material spillage e.g. on haul route or public road.
- sudden adverse weather which could generate a sudden increase in dust generation.

When unpredicted impacts are noted, suppression measures would be implemented immediately. These include:

- Increased use of water sprays and dust suppressants
- Reduced vehicle speed on haul/access roads; and/or
- Reduced intensity of dust-generating operations until effective dust control measures can be applied.

The following procedure will be implemented following recognition of an unexpected air quality impact:

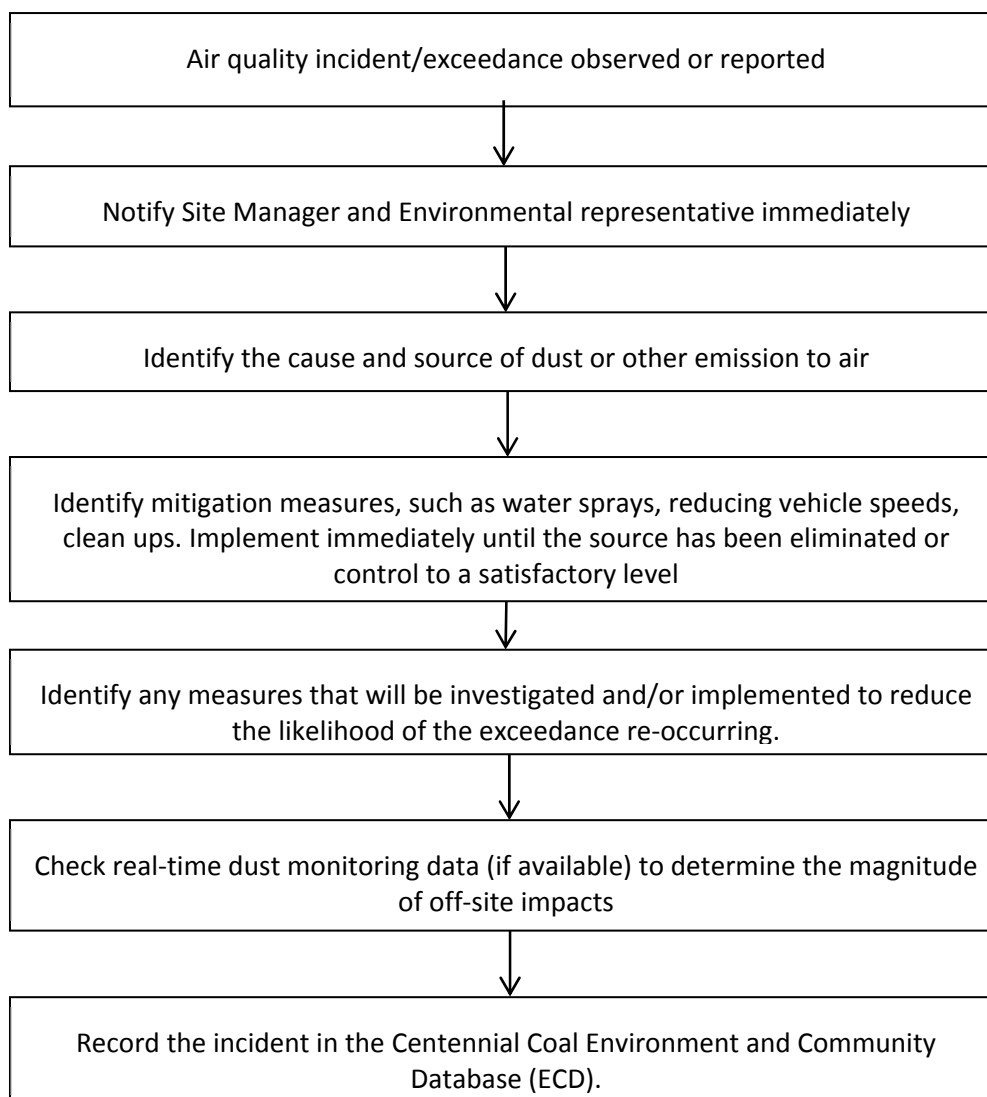

Figure 6 - Procedure for unexpected air quality impacts

5.2 Trigger Action Response Plans

The trigger action response plan (TARP) defines the minimum set of corrective actions that are required by site personnel in response to unpredicted impacts or deviation in the mine conditions from normality.

The TARP defines what is “normal” by way of a set of criteria for a range of aspects and are shown as green in the TARP. Criteria relating to abnormal conditions including trigger values are also defined in the TARP and are rated based on increased risk and potential impact and shown as orange or red. Corresponding corrective actions for each risk level are also clearly defined. The trigger levels are based on previous monitoring, conditions of approval and EPL criteria.

It is important to note that corrective actions do not have to wait until a trigger is exceeded. Site personnel may notice abnormal air quality behaviour and initiate corrective actions earlier than required under the TARP.

Table 5-1 - TARP – Air Quality

Aspect	Condition Green	Condition Orange	Condition Red
PM ₁₀	Trigger	Trigger	Trigger
	Monitoring results within criteria. PM ₁₀ trigger level not exceeded.	<p>Real time monitoring indicates PM₁₀ level exceeds trigger level of 50 µg/m³ over a 1 hour period. (note once tripped, alarms will not reset until back under trigger level)</p> <p style="text-align: center;">OR</p> <p>HVAS Monitoring data exceeds 80% of the PM₁₀ 24-hour air quality criteria (40 µg/m³).</p> <p style="text-align: center;">OR</p> <p>HVAS Annual average exceeds 80% of the PM₁₀ Annual Average air quality criteria (24 µg/m³).</p>	<p>HVAS or Real Time monitoring indicates an exceedance of the PM₁₀ 24-hour air quality criteria of 50 µg/m³.</p> <p style="text-align: center;">OR</p> <p>HVAS Monitoring indicates an exceedance of the PM₁₀ Annual Average criteria of 30 µg/m³ / 25 µg/m³.</p>
	Action	Action	Action
	No response required. Continue monitoring programme	Review operations to reduce dust emissions. Implement any additional mitigation measures as required. Modify operations if applicable.	Complete incident investigation to determine the cause of the exceedance. Review effectiveness of mitigation measures. Modify operations if applicable. Notify relevant government agencies and impacted landowners in accordance with the procedure in the

Aspect	Condition Green	Condition Orange	Condition Red
			Management Plan. Consider review of Management Plan if required.
TSP	Trigger	Trigger	Trigger
	Monitoring results within criteria	Monitoring result exceeds a TSP value of 90 µg/m ³ . OR Monitoring indicates annual average TSP level exceeds 80% of criteria level. (72 µg/m ³).	Monitoring results indicates an exceedance of the TSP Annual Average criteria of 90 µg/m ³ .
	Action	Action	Action
No response required. Continue monitoring programme	Review operations to reduce dust emissions. Implement any additional mitigation measures as required. Modify operations if applicable.	Complete incident investigation to determine the cause of the exceedance. Review effectiveness of mitigation measures. Modify operations if applicable. Notify relevant government agencies and impacted landowners in accordance with the procedure in the Management Plan. Consider review of Management Plan if required.	
	Trigger	Trigger	Trigger

Aspect	Condition Green	Condition Orange	Condition Red
Depositional Dust	Monitoring results within criteria	Monitoring indicates monthly depositional dust level exceeds 4 g/m ² /month. OR Monitoring indicates annual average Dust Depositional level exceeds 80% of criteria level (3.2 g/m ² /month).	Monitoring indicates annual average exceeds 4 g/m ² /month
	Action	Action	Action
	No response required. Continue monitoring programme	Analyse data to determine source of dust. Review operations to reduce dust emissions. Implement any additional mitigation measures as required. Modify operations if applicable.	Complete incident investigation to determine the cause of the exceedance. Review effectiveness of mitigation measures. Modify operations if applicable. Notify relevant government agencies and impacted landowners in accordance with the procedure in the Management Plan. Consider review of Management Plan if required.
Odour	Trigger	Trigger	Trigger
	No complaints or odour reports from site personnel.	On site identification of odour source reported.	External complaint of odour emissions received.
	Action	Action	Action

Aspect	Condition Green	Condition Orange	Condition Red
	No response required.	Analyse information to determine source of odour emissions. Review operations to reduce odour emissions if source of odour emissions determined to be from site.	Analyse information to determine source of odour emissions. Review operations to reduce odour emissions if source of odour emissions determined to be from site. Notify relevant government agencies and report complaint and actions implemented in the Annual Review.

6 Incidents, complaints and exceedances

6.1 Incidents

Non-compliances may be identified through regular reviews of monitoring data and site observations of visible dust plumes. Incidents may arise from an unexpected event such as a spillage or malfunction of equipment.

Any incidents, complaints and non-conformances that occur need to be reported in accordance with the Centennial Incident Reporting Standard (CIMOS-006), logged and corrective and preventable actions identified, including:

- Minor incidents resulting in no off-site impact but requiring immediate mitigation and instigation of any mitigation action(s); and
- Off-site impacts, such those which prompt complaints, requiring notification to the Site Manager or Environment & Community Coordinator.

In the event of an incident or complaint, the following procedure will be followed:

- Investigate the incident including:
 - The likely source of emission including microscopic analysis of dust deposition samples to identify the source of the dust;
 - If the incident is a failure to monitor, then the cause of the failure, for example vandalism or power failure.
- Mitigate the source immediately through:
 - application of mitigation (water sprays), relocate dust generating activities or cease the operation if mitigation is not feasible;
 - Replace broken bottles, investigate other options for power sources etc.
- Log the complaint/incident; and
- Create an incident report, including the corrective actions that were taken and who was involved, that documents preventative actions required to prevent a recurrence of the event and includes a sign-off by an authorised person at the site.

6.2 Community enquiries or complaints

Centennial will record and respond to any community enquiries or complaints received as described in the respective sites Community Complaints and Enquiries Procedure and investigate the nature of the complaint / enquiry.

Complaints will be followed up by the Mine Manager or Environment & Community Coordinator as soon as the outcomes of the investigation have been completed.

All community complaints and enquiries will be recorded in the Centennial Coal Environment and Community Database (ECD).

6.3 Non-compliance notification procedure

The following procedure will be implemented following a measured exceedance of an air quality indicator:

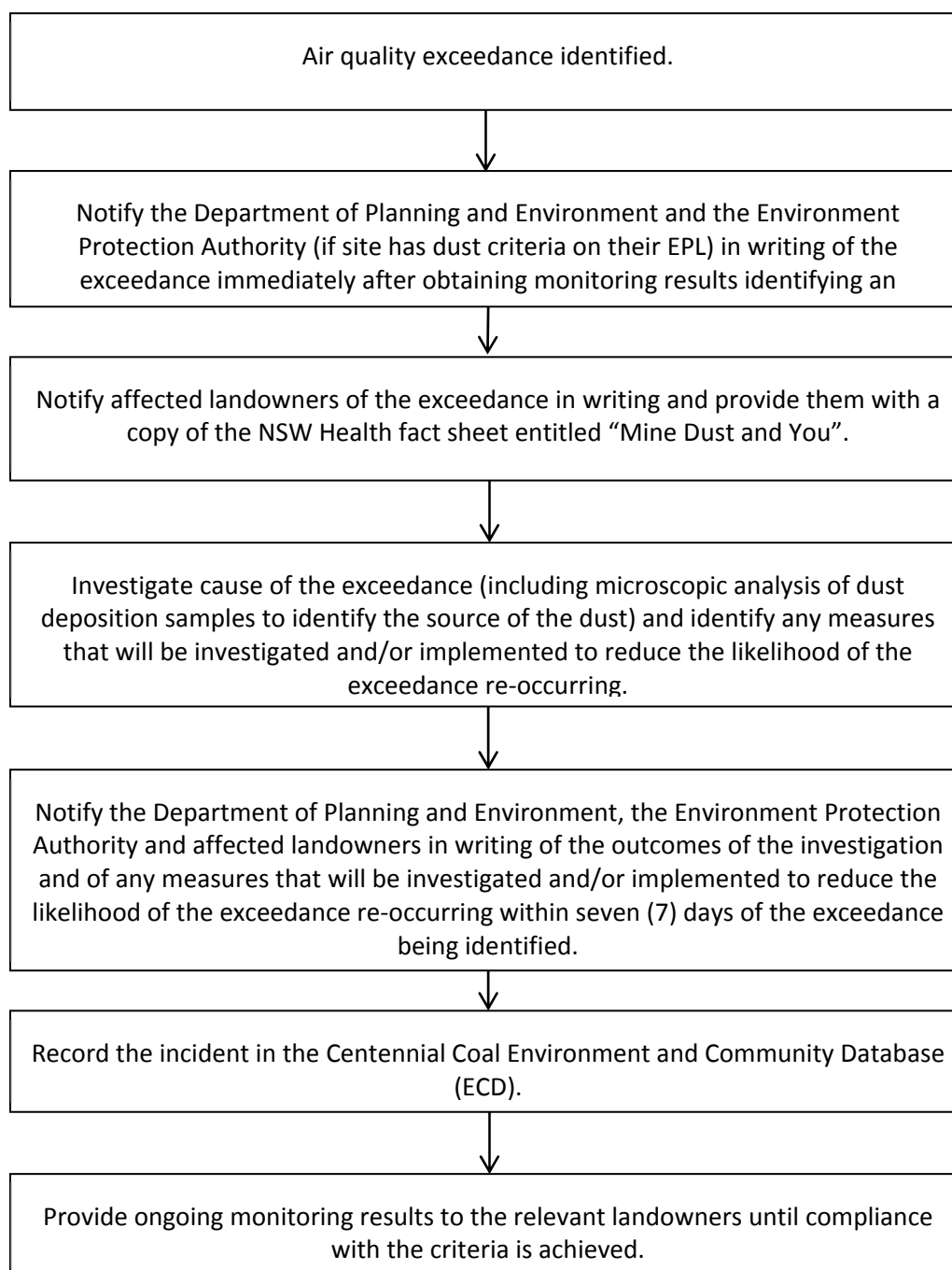

Figure 7 - Procedure for air quality exceedance

7 Roles and responsibilities

Each employee and contactor is responsible for adhering to the Centennial Coal Environmental Policy. Whilst the obligation of complying with the Environmental Policy lies with the entire workforce,

further environmental management responsibilities that are considered as a part of the normal functioning of some positions relevant to the EMS are described as follows:

Mine Manager

- Authorisation of the EMS;
- Responsible for approving environmental and community objectives and targets for the operations Annual Strategic Plan;
- Reporting of significant environmental incidents to external stakeholders as required;
- Promoting compliance with the Environmental Policy and fulfilling relevant requirements of the EMS and this Management Plan;
- Compliance with the requirements of the conditions of approval and EPL;
- Delegation of resources to ensure environmental risk mitigation strategies are implemented; and
- Delegation of duties during the absence of the Environment & Community Coordinator.

Mine/Operations Superintendents

- Maintaining the highest possible environmental standards within their designated areas of responsibility;
- Make use of all resources available to prevent or reduce environmental risks; and
- Immediately reporting environmental incidents and non-compliances to the Environment & Community Coordinator.

Environment & Community Coordinator

- Compliance with the Centennial Environmental Policy;
- Reporting of environmental incidents as required to external stakeholders;
- Development and implementation of environmental strategies, plans, and procedures;
- Regulatory and community consultation;
- Registration of community complaints and regulatory liaison in the Environment & Community Database (ECD);
- Development and implementation of environmental work procedures;
- Development and implementation of environmental training and inductions;
- Auditing the effectiveness of the EMS and this Management Plan; and
- Compliance with all licences and approvals for environmental management of the site.

Employees and Contractors

- Compliance with the Centennial Environmental Policy, standards and procedures;
- Immediately reporting of environmental incidents and community complaints or enquiries to the Environment & Community Coordinator;

- Conducting operations in compliance with the Centennial environmental management plans and procedures; and
- Identifying and implementing appropriate controls for environmental risks from any risk assessments and job safety analysis and communicating these with responsible staff.

Health, Safety, Environment & Community Committee

- Promoting environmental awareness within the workforce and contractors; and
- Raising environmental issues and programs that will improve compliance with the Environmental Policy, standards and procedures at committee meetings for appropriate staff to consider.

Delegation of roles or responsibilities may be determined by the Mine Manager at any time.

8 Training

Training of Centennial staff and contractors may include, but need not be limited to:

- Induction training;
- Environmental and community awareness training; and
- Toolbox training.

8.1 Induction training

All Centennial employees and contractors are inducted prior to commencing work on site. The environmental component of the new employees' induction includes:

- The importance of Centennial's Environmental Policy;
- Regulatory requirements;
- Overview of the framework of Centennial's EMS;
- Roles and responsibilities;
- Significant environmental aspects, impacts and consequences; and
- Environmental procedures.

Additionally, site specific issues are incorporated into the new employee and contractor site inductions and the competency of inducted personnel assessed.

Visitors to Centennial operations will undertake a brief visitor induction, with an awareness section on key environment components.

8.2 Targeted environmental training

Targeted environmental training of key staff, workforce and contractors in environmental procedures and programs will also be conducted. Specific environmental training may be delivered in the form of toolbox talks, training and assessment packages and accredited training programs to update personnel on the Centennial procedures and environmental programs.

8.3 Environmental training competence

The Centennial induction and environmental awareness training incorporates a section to assess the competency of employees and contractors against environmental requirements.

9 Management plan review

Revisions of this AQGHGMP are to be coordinated by the site Environment & Community Coordinator or delegate. The outcomes of a review will be documented by updating sections of these documents where required. Revised documents will be approved by the Group Environment Manager and submitted to DPE for approval. Once approved, the revised Management Plan will be placed on the Centennial Coal Website.

9.1 Review following an environmental audit

Audits can provide an assessment of compliance with conditions of approval, the EMS and management plans. They also allow for continual improvement and resource allocation.

The objectives of an audit are to:

- Identify compliance with the statutory requirements; and
- To identify opportunities for improvement.

This Management Plan will be reviewed following the completion of an environment audit.

9.2 Review following non compliance

Non-compliances may become evident as a result of inspections, monitoring, through audit findings or complaints. Non-compliances identified shall be investigated and consider:

- the cause of the non-conformance;
- a review of existing controls to identify modifications required to avoid repetition of the non-conformance; and
- identification of the appropriate corrective or preventative action.

This Management Plan will be reviewed following the completion of any non-compliance investigation.

9.3 Event based review

Other events which will trigger a review of this Management Plan include:

- Modifications / improvements to the system;
- Changes in the operation;
- New approvals, guidelines or codes of practice that require a review of the strategy; and
- or as otherwise directed by the Secretary.

Appendix A – Airly Mine

Conditions of Consent – Airly Mine (SSD 5581)

This Air Quality and Greenhouse Gas Management Plan has been prepared to satisfy the conditions of consent for the Airly Mine (SSD 5581). The conditions of consent that relate to this Air Quality and Greenhouse Gas Management Plan and where they have been addressed is provided below.

Table 1 - Conditions of Consent – Airly Mine

Condition No.	Condition of Consent	Where addressed
Schedule 4 Condition 6	The Applicant must:	
Schedule 4 Condition 6 (a)	Implement all reasonable and feasible measures to minimise the: <ul style="list-style-type: none"> • Odour, fume and dust emissions from the development; • Release of greenhouse gas emissions from the development; 	Section 3
Schedule 4 Condition 6 (b)	Minimise any visible air pollution generated by the development;	Section 5
Schedule 4 Condition 6 (c)	Minimise the surface disturbance of the site generated by the development; and	Section 3
Schedule 4 Condition 6 (d)	Minimise the air quality impacts of the development during adverse meteorological conditions and extraordinary events (see note d to Table 5). To the satisfaction of the Secretary	Section 5
Schedule 4 Condition 7	Prior to carrying out any development under this consent, unless the Secretary agrees otherwise, the Applicant must prepare an Air Quality Management Plan for the development to the satisfaction of the Secretary.	Development commenced 31 January 2017. Request for an extension of time to submit the Management Plan from DPE, which was approved until 30 April 2017.

Condition No.	Condition of Consent	Where addressed
		The Management Plan was submitted to DPE for approval on 28 April 2017.
Schedule 4 Condition 7(a)	This plan must: be prepared in consultation with the EPA;	This Air Quality and Greenhouse Gas Management Plan was prepared in consultation with the EPA. A consultation log is provided as Appendix H.
Schedule 4 Condition 7(b)	describe all reasonable and feasible measures which would be implemented to ensure compliance with the air quality criteria and operating conditions of this consent;	Section 3.1 Appendix A
Schedule 4 Condition 7(c)	describe the air quality management system in detail;	Section 3
Schedule 4 Condition 7(d)	include an air quality monitoring program that:	
	uses monitors to evaluate the performance of the development against the air quality criteria in this consent;	Section 4
	adequately supports the air quality management system;	Section 4 Section 4.5
	evaluates and reports on:	
	the effectiveness of the air quality management system; and	Section 4.5
	compliance with the air quality criteria and operating conditions in condition 6 above;	Section 4.5
	defines what constitutes an air quality incident, and includes a protocol for identifying and notifying the Department and relevant stakeholders of any air quality incidents.	Section 6

Condition No.	Condition of Consent	Where addressed
Schedule 4 Condition 7	The Applicant must implement the approved Air Quality Management Plan for the development	This Management Plan

Overview

The sections below provide site specific information which supplements the information provided in the AQGHGMP around 'common' dust sources, mitigation and management measures.

Site specific sources of dust are identified. Dust mitigation and management measures which are specific to Airly Mine operations are also outlined and discussed.

The dust monitoring network around Airly Mine is also outlined. As discussed in the AQGHGMP, a short term and long term approach has been taken when preparing the dust monitoring program for Centennial operations. The short term monitoring has been prepared to satisfy the existing regulatory requirements for Airly Mine. The long term program has been prepared as part of the regional management plan and may require a transitional period where changes from short term and long term are discussed with the relevant authorities, finalised and implemented.

As the timing for the commencement of construction activities associated with the Airly Mine Extension Project is uncertain, this Management Plan addresses the operational aspects of the Airly Mine Extension Project only. Once construction activities and timing has been confirmed, this Management Plan will need to be updated to include construction specific monitoring and management measures and re-submitted for approval. Approval of the management plan with the construction activities included will be sought prior to the construction activities commencing.

Site specific dust sources

The following identified sources of dust emissions in the AQGHGMP are relevant for Airly Mine operations:

- Wind erosion from coal stockpiles
- Wind erosion from disturbed areas and coal stockpiles
- Wheel generated dust from vehicle movements
- Fugitive emissions from coal handling and processing
- Fugitive emissions through mine ventilation fans as a result of underground mining operations
- Rail loading operations
- Coal transporting activities (conveyor, truck, rail)
- Operation of mobile equipment.

There are no additional sources of dust specifically identified for Airly Mine operations.

Site specific dust mitigation and management measures

Airly Mine implements dust mitigation in accordance with the mitigation measures outlined in **Section 3.1** of the AQGHGMP.

Key dust mitigation measures for Airly Mine operations include:

- Signage to display speed limits on all unsealed roads in the surface facilities area;
- Water sprays on unsealed areas during use or windy conditions; and
- Water sprays (sprinkler system) on the coal product stockpile during dry and windy conditions.

All mitigation measures identified in the AQGHGMP are utilised as required and implementation of appropriate dust controls are triggered by a range of methods, including:

- Dust monitoring results, indicating an elevated level of dust fall out;
- Site inspections and observation of visible dust plumes; and
- Meteorological data from the Airly Homestead weather station.

Airly Mine operates in accordance with the Trigger Action Response Plan (TARP) provided in **Section 5.2** of the AQGHGMP.

Dust monitoring

Airly Mine has operated a dust monitoring program for several years, which consists of four dust deposition gauges, collected monthly, located within and around the mining operations. A review of this dust monitoring network was undertaken following issue of the Draft Conditions of Approval (SSD_5581) for the Airly Mine Extension Project in 2015. The aim of this review was to identify methods to improve the efficiency and value provided from the dust monitoring network. The review considered:

- changes in the regulatory requirements since the previous Consent and EPL;
- changes in operations and predicted dust impacts from environmental assessments;
- long term trends in monitoring data from Annual Reviews and monthly monitoring reports; and
- complaints relating to air quality.

A detailed discussion around the rationalisation of the dust monitoring network is provided in *Centennial Western Region Environmental Monitoring Rationalisation, Review and Recommendations* (GHD 2015).

The short term and long term monitoring programs are outlined below. The timing to implement the long term monitoring program depends on many factors, such as regulatory approvals, landholder consultation, procurement of equipment and installation.

Short term

Consent SSD_5581 does not specify dust monitoring locations. The short term monitoring program consists of four dust deposition gauges:

- Dust gauge DG1 is located south of the operations and nearby a sensitive receiver location designated as A7 (isolated rural residence)). This site was predicted to have very low impacts at this location and has not received complaints relating to dust. As this is a very low risk site it is suggested that this site be a background site.
- Dust gauge DG2 is located near sensitive receiver A1. This receiver is not predicted¹ to be adversely impacted by dust generation from mining operations.
- Dust gauge DG3 is not at a sensitive receiver but is close by to mine operations.
- Dust gauge DG4 is located on mine-owned land to the southwest of the surface facilities. This location is upwind of the prevailing south-westerly winds, however will be utilised to determine impacts in the south westerly direction.

The short term dust monitoring network is shown in **Figure 1**

Long term

The long term dust monitoring locations have been selected based on the rationalisation of the short term monitoring network. Changes to the long term monitoring program include the following:

- Monitoring at DG2 will be removed from A1, based on:
 - Long term compliance with dust criteria from historical monitoring;
 - Low predicted impacts; and
 - Lack of complaints relating to dust.
- DG2 will be relocated to sensitive receiver A2, to represent sensitive receivers A2 to A5 in the long term. Sensitive receiver A2 is where modelling predicted the (relatively) highest impacts, and this site also receives impacts from mine operations inclusive of the rail loop and reject emplacement area. The final location of DG2 will be dependent on agreement being reached with the resident, and an access agreement being achieved.
- Dust gauge DG3 which is close by to mine operations will be relocated in the long term closer towards sensitive receivers A2 to A5. This DG however will still remain on mine owned land.
- The installation of PM₁₀ & TSP monitoring at DG2.

The long term dust monitoring network will therefore continue to consist of four dust deposition gauges and HVAS monitors for PM₁₀ and TSP. The PM₁₀ and TSP monitoring site is to be located to determine the dust impacts on the sensitive receivers A2 to A5. The final location of this monitoring is proposed to be with DG2, and will be dependent on agreement being reached with the resident,

¹ Airly Mine Extension Project, Air Quality Impact Assessment and Greenhouse Gas Assessment (SLR, 2014).

and an access agreement being achieved. The long term dust monitoring network is shown in **Figure 2**.

This Management Plan forms part of the consultation process for moving from the short term monitoring program to the long term monitoring program. This management plan will need to be approved prior to the site moving to the long term monitoring program and will be subject to agreement with landowners. If the Long term monitoring program is different to what is detailed in an EPL, then an EPL variation will also be sought prior to moving to the long term monitoring program.

A summary of the dust monitoring to be undertaken at Airly Mine is provided in **Table 2** and **Table 3**.

Table 2 - Airly Mine short term dust monitoring locations

Site ID	X (m)	Y (m)	Parameter	Instrument	Frequency	Purpose
DG1	778975*	6329348	Dust deposition	DDG	Monthly	Background
DG2	222565	6332059	Dust deposition	DDG	Monthly	Compliance
DG3	220642	6332514	Dust deposition	DDG	Monthly	Compliance
DG4	219846	6331486	Dust deposition	DDG	Monthly	Compliance

Notes:

Background – the monitoring site is representative of ‘background’ levels since it is remote from dust generating activities.

Compliance – the monitoring site is at a sensitive receptor location and therefore used for compliance purposes.

* MGA55. All others are MGA56.

Table 3 - Airly Mine long term dust monitoring locations

Site ID	X (m)	Y (m)	Parameter	Instrument	Frequency	Purpose
DG1	778872*	632950	Dust deposition	DDG	Monthly	Background
DG2	218907	633294	Dust deposition	DDG	Monthly	Compliance

Site ID	X (m)	Y (m)	Parameter	Instrument	Frequency	Purpose
DG3	220376	633243	Dust deposition	DDG	Monthly	Compliance
DG4	219846	633148	Dust deposition	DDG	Monthly	Compliance
PM ₁₀ & TSP Monitor	218907	633294	PM10 & TSP	To be determined	Every 6 Days	Compliance

Notes:

Background – the monitoring site is representative of ‘background’ levels since it is remote from dust generating activities.

Compliance – the monitoring site is at a sensitive receptor location and therefore used for compliance purposes.

* MGA55. All others are MGA56.

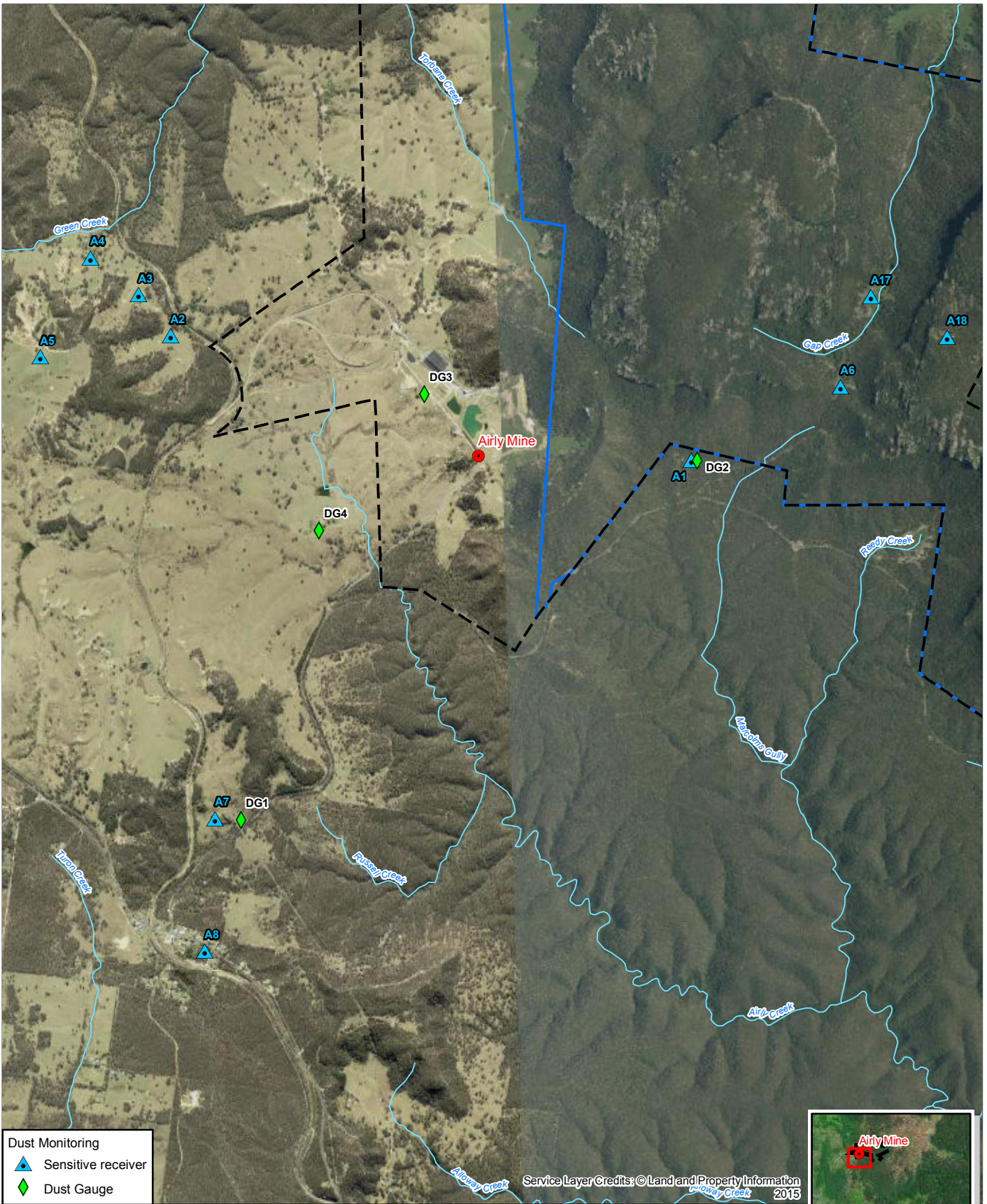

Dust Monitoring

- Sensitive receiver
- Dust Gauge

Service Layer Credits: © Land and Property Information 2015

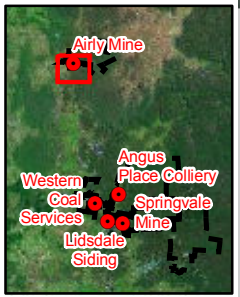

1:40,000 for A4

0 0.35 0.7 1.05 1.4

Kilometres

Map Projection: Universal Transverse Mercator
Horizontal Datum: Geodetic Datum of Australia 1994
Grid: Map Grid of Australia, Zone 56

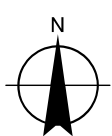

LEGEND

- Centennial Site Location
- ML1331 Boundary
- A232 Boundary
- Watercourse

LOCATION	-
SEAM	NA
DRAWN	F.Mackay
CHECKED	T.G
APPROVED	LH
SCALE	Refer to scalebar

**Centennial Western Region
Environmental Monitoring**

**Airly
Short Term Dust Monitoring**

**Centennial
Coal**

DATE 9/03/2017	Figure 1
----------------	----------

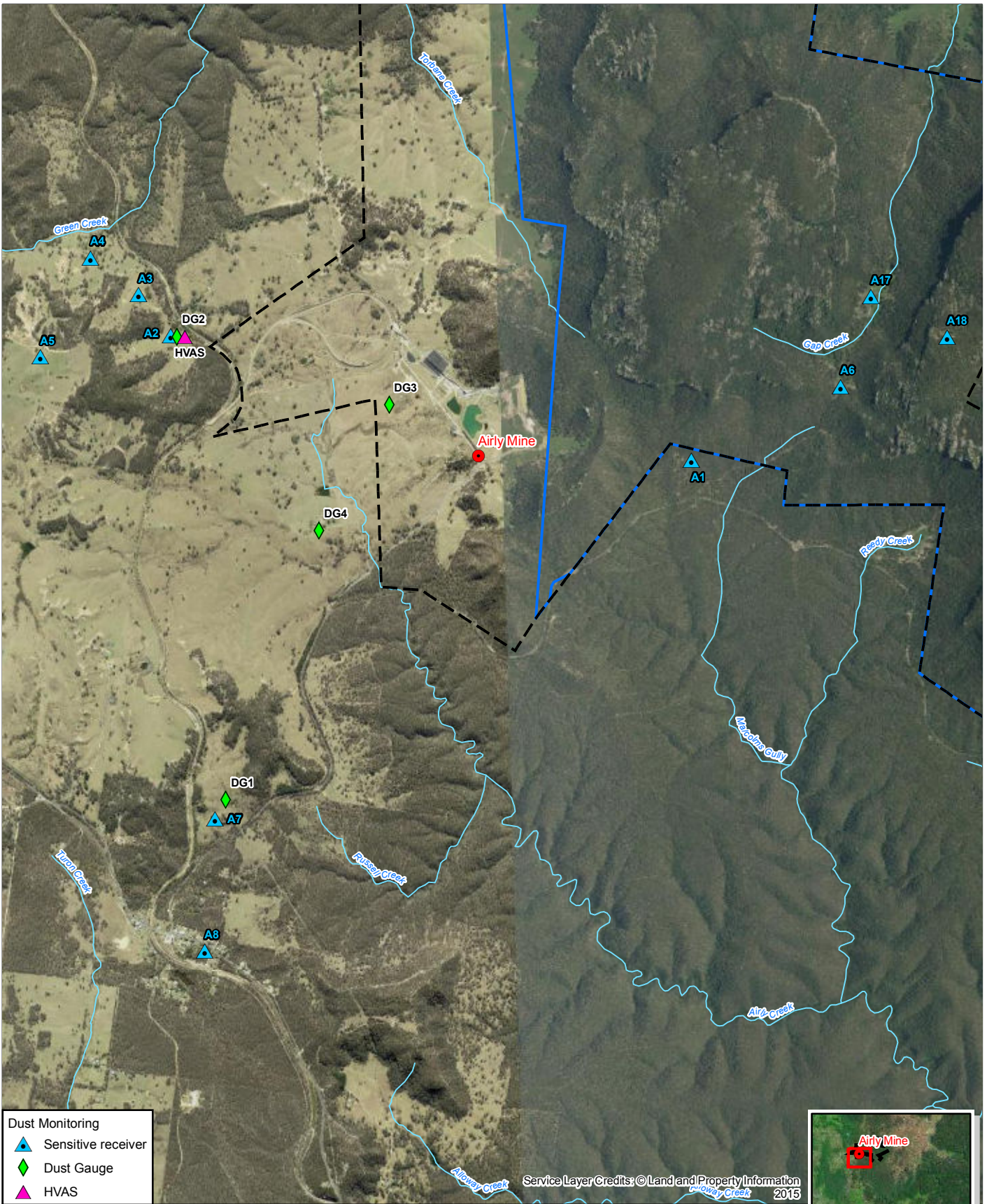

Dust Monitoring

- Sensitive receiver
- Dust Gauge
- HVAS

1:40,000 for A4

0 0.35 0.7 1.05 1.4

Kilometres

Map Projection: Universal Transverse Mercator
Horizontal Datum: Geodetic Datum of Australia 1994
Grid: Map Grid of Australia, Zone 56

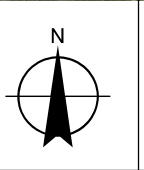

LEGEND

- Centennial Site Location
- ML1331 Boundary
- A232 Boundary
- Watercourse

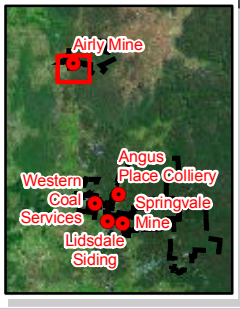

<small>© 2017. Whilst every care has been taken to prepare this map, GHD, NSW Office of Water and ESRI make no representations or warranties about its accuracy, reliability, completeness or suitability for any particular purpose and cannot accept liability and responsibility of any kind (whether in contract, tort or otherwise) for any expenses, losses, damages and/or costs (including indirect or consequential damage) which are or may be incurred by any party as a result of the map being inaccurate, incomplete or unsuitable in any way and for any reason.</small>	LOCATION	-
	SEAM	NA
	DRAWN	F.Mackay
	CHECKED	T.G
	APPROVED	LH
	SCALE	Refer to scalebar

**Centennial Western Region
Environmental Monitoring**

**Airly
Long Term Dust Monitoring**

**Centennial
Coal**

DATE	9/03/2017	Figure 2
------	-----------	----------

Meteorological monitoring

In accordance with Condition 8 of the conditions of approval, meteorological data for Airly Mine is measured from Airly Homestead weather station.

The weather station continuously monitors weather parameters. Supplementary weather data could be obtained from the on-site meteorological monitoring station at Charbon Colliery or from the Running Stream (Brooklyn) Bureau of Meteorology station number 063012. Monitoring parameter are summarised in **Table 4**.

Table 4 - Airly Mine meteorological monitoring

Site ID	X (m)	Y (m)	Parameter	Instrument	Frequency	Purpose
Airly Homestead AWS	219674	6330929	Temperature Humidity Barometric Pressure Wind – speed and direction Rainfall Solar radiation	Automatic weather station	10 minute data intervals	Proactive monitoring Weather analysis during noise monitoring Rainfall information

Greenhouse Gas

GHG management and monitoring procedures are documented in **Section 3.2.2** of the AQGHGMP.

There are no specific management or monitoring requirements for GHG at Airly Mine.

Appendix B – Angus Place Colliery

Conditions of Consent – Angus Place (MP 06_0021)

This Air Quality and Greenhouse Gas Management Plan has been prepared to satisfy the conditions of consent for the Angus Place Colliery (MP 06_0021). The conditions of consent that relate to this Air Quality and Greenhouse Gas Management Plan and where they have been addressed is provided below.

Table 1 - Conditions of Consent – Angus Place Colliery

Condition No.	Condition of Consent	Where addressed
Schedule 3 Condition 16	The Proponent shall prepare (and following approval implement) an Air Quality Monitoring Program for the project, to the satisfaction of the Secretary.	The original Air Quality Monitoring Program was approved by the Secretary on 21 March 2007. A revised Air Quality Monitoring Program was approved 22 October 2013. This Air Quality and Greenhouse Gas Management Plan was originally submitted to the DPE on 11 February 2016 and approved by the Secretary on 22 July 2016. The Management Plan was revised and resubmitted to the DPE on 28 April 2017.
	The program must include an air monitoring protocol for evaluating compliance with the air quality criteria in this approval.	Section 4 Appendix B
	The program shall be prepared in consultation with EPA, and be submitted to the Secretary within 6 months of the date of this approval.	This Air Quality and Greenhouse Gas Management Plan was prepared in consultation with the EPA. A consultation log is provided as Appendix H.

Condition No.	Condition of Consent	Where addressed
		<p>This Air Quality and Greenhouse Gas Management Plan was originally submitted to the DPE on 11 February 2016 and approved by the Secretary on 22 July 2016.</p> <p>The Management Plan was revised and resubmitted to the DPE on 28 April 2017.</p>

Overview

The sections below provide site specific information which supplements the information provided in the AQGHGMP around 'common' dust sources, mitigation and management measures.

Site specific sources of dust are identified. Dust mitigation and management measures which are specific to Angus Place Colliery operations are also outlined and discussed.

The dust monitoring network around Angus Place Colliery is also outlined. As discussed in the AQGHGMP, a short term and long term approach has been taken when preparing the dust monitoring program for Centennial operations. The short term monitoring has been prepared to satisfy the existing regulatory requirements for Angus Place Colliery. The long term program has been prepared as part of the regional management plan and may require a transitional period where changes from short term and long term are discussed with the relevant authorities, finalised and implemented.

Site specific dust sources

The following identified sources of dust emissions in the AQGHGMP are relevant for Angus Place Colliery operations:

- Wind erosion from coal stockpiles
- Wind erosion from disturbed areas and coal stockpiles
- Wheel generated dust from vehicle movements
- Fugitive emissions from coal handling and processing
- Fugitive emissions through mine ventilation fans as a result of underground mining operations
- Coal transporting activities (haul road)
- Operation of mobile equipment.

There are no additional sources of dust specifically identified for Angus Place Colliery operations.

Site specific dust mitigation and management measures

Angus Place Colliery implements dust mitigation in accordance with the mitigation measures outlined in Section 3.1 of the AQGHGMP.

Key dust mitigation measures for Angus Place Colliery operations include:

- Signage to display speed limits on all unsealed roads in the surface facilities area
- Water sprays on unsealed areas during use or windy conditions
- Water sprays (sprinkler system) on the coal product stockpile during dry and windy conditions.

All mitigation measures identified in the AQGHGMP are utilised as required and implementation of appropriate dust controls are triggered by a range of methods, including:

- Dust monitoring results, indicating an elevated level of dust beyond the site boundary
- Site inspections and observation of visible dust plumes
- Meteorological data from the Angus Place AWS.

Angus Place Colliery operates in accordance with the Trigger Action Response Plan (TARP) provided in Section 5.2 of the AQGHGMP.

Dust monitoring

Approval 06_0021 specifies dust criteria for Angus Place Colliery but does not nominate dust monitoring locations.

Angus Place Colliery has operated this dust monitoring program for several years. A review of this dust monitoring network was undertaken in 2015. The aim of this review was to identify methods to improve the efficiency and value provided from the dust monitoring network. The review considered:

- changes in the regulatory requirements
- changes in operations and predicted dust impacts from environmental assessments
- long term trends in monitoring data from Annual Reviews and monthly monitoring reports
- complaints relating to air quality.

A detailed discussion around the rationalisation of the dust monitoring network is provided in *Centennial Western Region Environmental Monitoring Rationalisation, Review and Recommendations* (GHD 2015).

The short term and long term monitoring programs are outlined below. The timing to implement the long term monitoring program depends on many factors, such as regulatory approvals, landholder consultation, procurement of equipment and installation.

Short term

The short term monitoring program will remain unchanged from what is currently undertaken. Angus Place Colliery has eight depositional dust gauges, all located on Centennial-owned land in vicinity of the surface operations. These dust gauges have been operational since January 2001.

High Volume Air Sampling (HVAS) equipment, used to measure PM₁₀ and TSP, was installed in May 2009 at one location to the southwest of the Pit Top, in the vicinity of the nearest neighbour. The HVAS monitoring equipment operates on a one in six day cycle to record ambient concentrations of PM₁₀ and TSP.

The short term dust monitoring network is shown in **Figure 1**.

Long term

The long term dust monitoring locations have been selected based on the rationalisation of the short term monitoring network.

A number of dust gauges were determined to add little value to the dust monitoring network and their ability to determine compliance at sensitive receptor locations were limited. These gauges will be removed from the dust monitoring network in the long term due to the lack of value they provide. The long term dust gauge network is reduced to three. The ability to assess compliance at the nearest sensitive receptors has not been compromised.

Concerning the co-located TSP and PM₁₀ HVAS monitoring:

- Historical data for daily PM₁₀ monitoring is consistently well below the criterion
- The annual average TSP is consistently well below the criterion. Monitoring and modelling data indicates that the risk of the TSP criterion being exceeded is extremely low.
- Having established a consistent TSP to PM₁₀ ratio over several annual cycles, the TSP measurements may be removed.
- The ratio between TSP and PM₁₀ concentrations has been calculated from long term monitoring data to be 0.44. The measured PM₁₀ annual average would therefore be divided by 0.44 to estimate the annual average TSP concentration².

The long term dust monitoring network will therefore consist of three dust deposition gauges (DG2, DG5 and DG6) and one HVAS with PM₁₀ inlet.

The long term dust monitoring network is shown in **Figure 2**.

This Management Plan forms part of the consultation process for moving from the short term monitoring program to the long term monitoring program. This management plan will need to be approved prior to the site moving to the long term monitoring program. If the Long term monitoring program is different to what is detailed in an EPL, then an EPL variation will also be sought prior to moving to the long term monitoring program.

² Average ratio of PM₁₀ to TSP calculated over monitoring data from annual summary 2013 and 2014.

A summary of the dust monitoring to be undertaken at Angus Place Colliery is provided in **Table 2** and **Table 3**.

Table 2 - Angus Place Colliery short term dust monitoring locations

Site ID	X (m)	Y (m)	Parameter	Instrument	Frequency	Purpose
DG1	229903	6306294	Dust deposition	DDG	Monthly	Ambient
DG2	230587	6306214	Dust deposition	DDG	Monthly	Background
DG3	230272	3606010	Dust deposition	DDG	Monthly	Background
DG4	229996	6305908	Dust deposition	DDG	Monthly	Ambient
DG5	229535	6305348	Dust deposition	DDG	Monthly	Compliance
DG6	229978	6305391	Dust deposition	DDG	Monthly	Ambient
DG7	230218	3605618	Dust deposition	DDG	Monthly	Compliance
DG8	230688	6305776	Dust deposition	DDG	Monthly	Ambient
HVAS	229903	6305303	PM ₁₀	HVAS	Special Frequency 1	Compliance
HVAS	230587	6305303	TSP	HVAS	Special Frequency 1	Compliance

Notes:

Ambient – the monitoring equipment is not at a sensitive receptor location. This monitoring location was selected to provide information regarding dust levels close to sources such as haul roads, ventilation fans or surface operations.

Background – the monitoring site is representative of ‘background’ levels since it is remote from dust generating activities.

Compliance – the monitoring site is at a sensitive receptor location and therefore used for compliance purposes.

Special Frequency 1 - means the collection of samples over 2 months per year (a total of 10 x 6 day sampling periods).

Table 2 - Angus Place Colliery long term dust monitoring locations

Site ID	X (m)	Y (m)	Parameter	Instrument	Frequency	Purpose
DG3	230272	3606010	Dust deposition	DDG	Monthly	Background
DG5	229535	6305348	Dust deposition	DDG	Monthly	Compliance
DG6	229978	6305391	Dust deposition	DDG	Monthly	Ambient
HVAS	229464	6305303	PM ₁₀	HVAS	1-in-6 day	Compliance

Notes:

Ambient – the monitoring equipment is not at a sensitive receptor location. This monitoring location was selected to provide information regarding dust levels close to sources such as haul roads, ventilation fans or surface operations.

Background – the monitoring site is representative of ‘background’ levels since it is remote from dust generating activities.

Compliance – the monitoring site is at a sensitive receptor location and therefore used for compliance purposes.

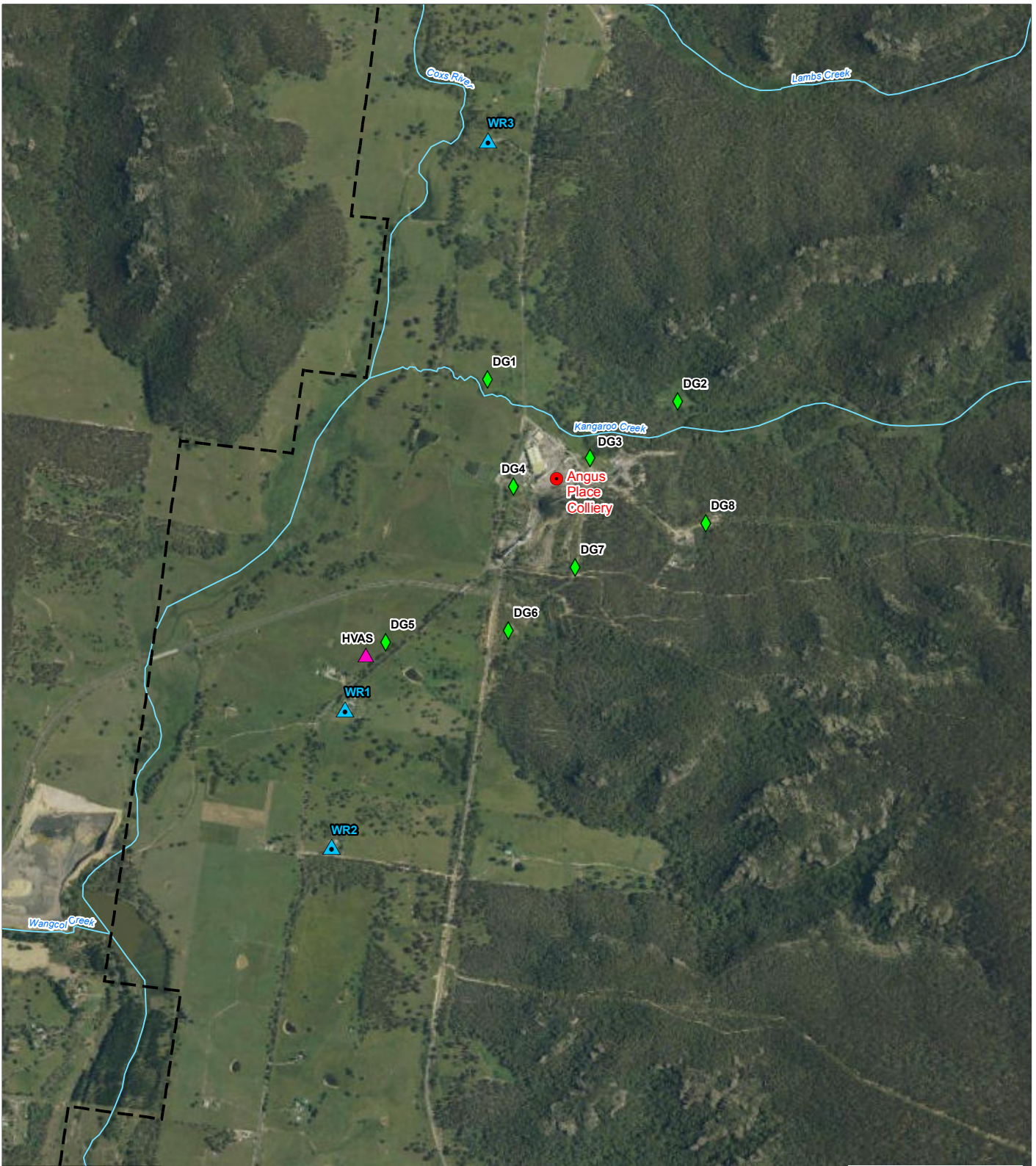

Service Layer Credits: © Land and Property Information 2015

Dust Monitoring

- Sensitive receiver
- Dust Gauge
- HVAS

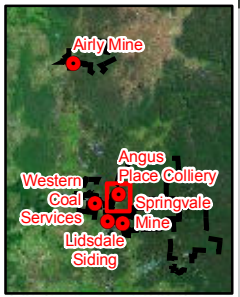

1:20,000 for A4

0 0.15 0.3 0.45 0.6
Kilometres

Map Projection: Universal Transverse Mercator
Horizontal Datum: Geodetic Datum of Australia 1994
Grid: Map Grid of Australia, Zone 56

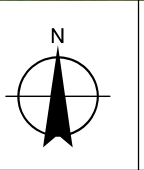

LEGEND

- Centennial Site Location
- Colliery Holding Boundary
- Watercourse

© 2017. Whilst every care has been taken to prepare this map, GHD, NSW Office of Water and ESRI make no representations or warranties about its accuracy, reliability, completeness or suitability for any particular purpose and cannot accept liability and responsibility of any kind (whether in contract, tort or otherwise) for any expenses, losses, damages and/or costs (including indirect or consequential damage) which are or may be incurred by any party as a result of the map being inaccurate, incomplete or unsuitable in any way and for any reason.

LOCATION	-
SEAM	NA
DRAWN	F.Mackay
CHECKED	T.G
APPROVED	LH
SCALE	Refer to scalebar

**Centennial Western Region
Environmental Monitoring**

**Angus Place
Short Term Dust Monitoring**



**Centennial
Coal**

DATE	9/03/2017	Figure 1
------	-----------	----------

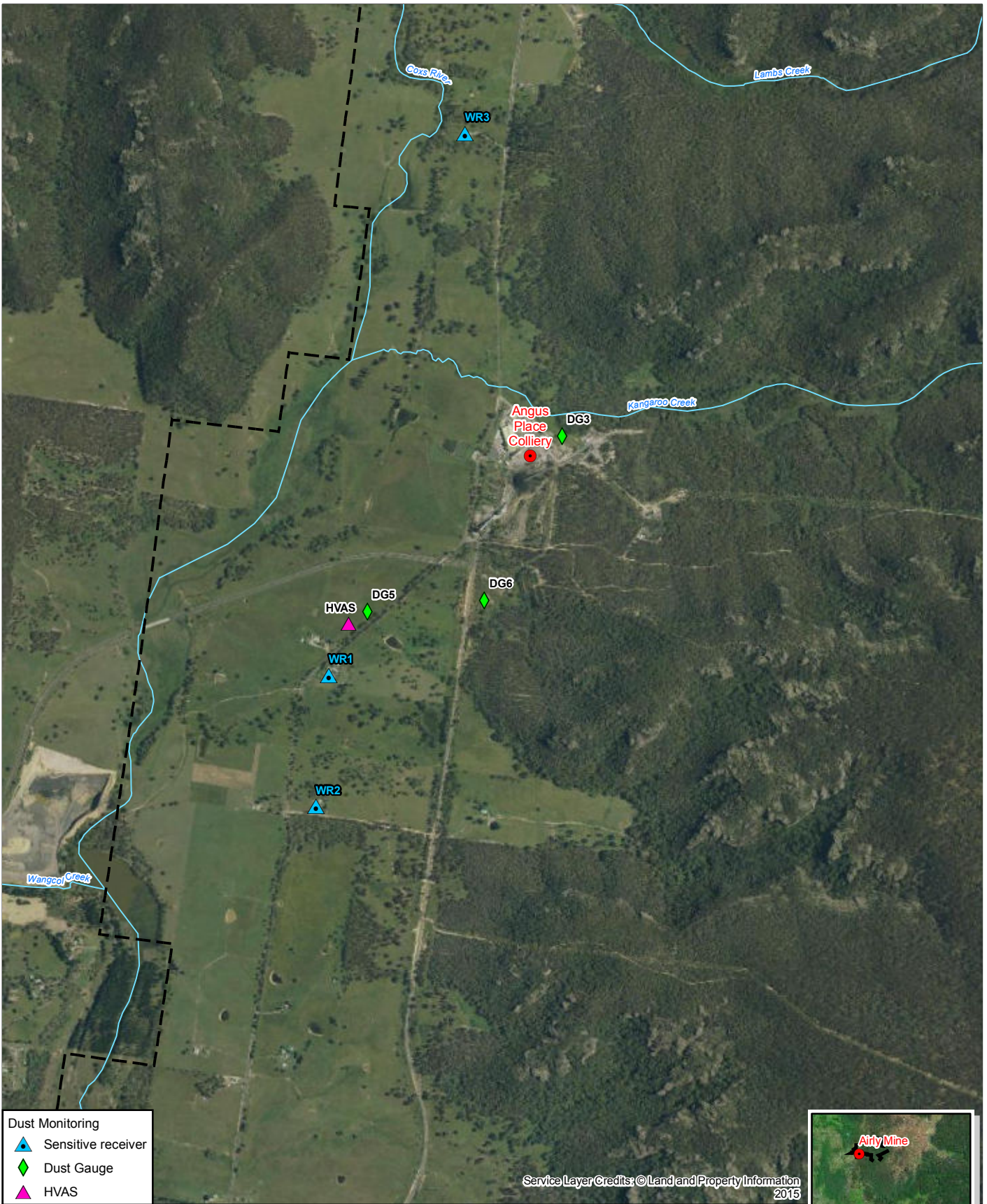

Service Layer Credits: © Land and Property Information 2015

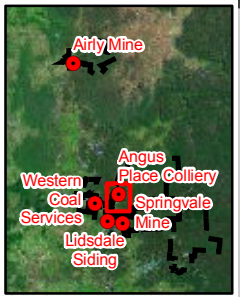

Dust Monitoring	
	Sensitive receiver
	Dust Gauge
	HVAS

1:20,000 for A4

Map Projection: Universal Transverse Mercator
Horizontal Datum: Geodetic Datum of Australia 1994
Grid: Map Grid of Australia, Zone 56

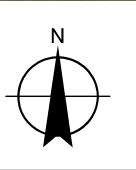

LEGEND

- Centennial Site Location
- Colliery Holding Boundary
- Watercourse

<small>© 2017. Whilst every care has been taken to prepare this map, GHD, NSW Office of Water and ESRI make no representations or warranties about its accuracy, reliability, completeness or suitability for any particular purpose and cannot accept liability and responsibility of any kind (whether in contract, tort or otherwise) for any expenses, losses, damages and/or costs (including indirect or consequential damage) which are or may be incurred by any party as a result of the map being inaccurate, incomplete or unsuitable in any way and for any reason.</small>	LOCATION	-
	SEAM	NA
	DRAWN	F.Mackay
	CHECKED	T.G
	APPROVED	LH
	SCALE	Refer to scalebar

**Centennial Western Region
Environmental Monitoring**

**Angus Place
Long Term Dust Monitoring**

**Centennial
Coal**

DATE	9/03/2017	Figure 2
------	-----------	----------

Meteorological monitoring

Meteorological data for Angus Place Colliery is measured at two locations, from Angus Place AWS and Angus Place Vent Facility AWS.

The weather stations continuously monitor weather parameters.

Table 4 - Angus Place meteorological monitoring

Site ID	X (m)	Y (m)	Parameter	Instrument	Frequency	Purpose
Angus Place AWS	229846	6306001	Temperature Humidity Barometric Pressure	Automatic weather station	10 minute data intervals	Proactive monitoring Weather analysis during noise monitoring Rainfall information
Angus Place Vent Facility AWS	237198	6305700	Wind – speed and direction Rainfall Solar radiation Sigma-theta			

Greenhouse Gas

GHG management and monitoring procedures are documented in **Section 3.2.2** of the AQGHGMP.

There are no specific management or monitoring requirements for GHG at Angus Place Colliery.

Appendix C - Clarence Colliery

Conditions of Consent – Clarence Colliery (DA 504-00)

This Air Quality and Greenhouse Gas Management Plan has been prepared to satisfy the conditions of consent for the Clarence Colliery (DA 504-00). The conditions of consent that relate to this Air Quality and Greenhouse Gas Management Plan and where they have been addressed is provided below.

Table 1 - Conditions of Consent – Clarence Colliery

Condition No.	Condition of Consent	Where addressed
<p>Schedule 3 Condition 14</p>	<p>Within 6 months of the date of this consent, the Applicant shall prepare and subsequently implement an Air Quality Monitoring Program for the development, in consultation with EPA, and to the satisfaction of the Secretary</p>	<p>This Air Quality and Greenhouse Gas Management Plan was prepared in consultation with the EPA. A consultation log is provided as Appendix H.</p> <p>The original Air Quality Monitoring Program was approved by the Secretary on 20 August 2007. A revised Air Quality Monitoring Program was submitted to the DPE on the 18th July 2014. No formal approval of this Monitoring Programme was received.</p> <p>This Air Quality and Greenhouse Gas Management Plan was submitted to the DPE on 11 February 2016 and approved by the Secretary on 22 July 2016.</p> <p>The Management Plan was revised and resubmitted to the DPE on 28 April 2017.</p>

Condition No.	Condition of Consent	Where addressed
	This program must include an air monitoring protocol for evaluating compliance with the air quality criteria in this consent.	Section 4 Appendix C

Overview

The purpose of this Management Plan is to provide methods of monitoring environmental dust generated from Clarence Colliery and demonstrate compliance with DA 504-00 and Environmental Protection Licence 726. This Management Plan forms a part of the Clarence Colliery Occupational Health, Safety and Environment Management System.

The sections below provide site specific information which supplements the information provided in the AQGHGMP around 'common' dust sources, mitigation and management measures.

Site specific sources of dust are identified. Dust mitigation and management measures which are specific to Clarence Colliery operations are also outlined and discussed.

The dust monitoring network around Clarence Colliery is also outlined. As discussed in the AQGHGMP, a short term and long term approach has been taken when preparing the dust monitoring program for Centennial operations. The short term monitoring has been prepared to satisfy the existing regulatory requirements for Clarence Colliery. The long term program has been prepared as part of the regional management plan and may require a transitional period where changes from short term and long term are discussed with the relevant authorities, finalised and implemented.

Site specific dust sources

The following identified sources of dust emissions in the AQGHGMP are relevant for Clarence Colliery operations:

- Wind erosion from coal stockpiles;
- Wind erosion from disturbed areas and coal stockpiles;
- Wheel generated dust from vehicle movements;
- Fugitive emissions from coal handling and processing;
- Fugitive emissions through mine ventilation fans as a result of underground mining operations;
- Coal transporting activities (haul road); and
- Operation of mobile equipment.

There are no additional sources of dust specifically identified for Clarence Colliery operations.

Site specific dust mitigation and management measures

Clarence Colliery implements dust mitigation in accordance with the mitigation measures outlined in **Section 3.1** of the AQGHGMP.

Key dust mitigation measures for Clarence Colliery operations include:

- Signage to display speed limits on all unsealed roads in the surface facilities area;
- Water sprays on unsealed areas during use or windy conditions; and
- Water sprays (sprinkler system) on the coal product stockpile during dry and windy conditions.

All mitigation measures identified in the AQGHGMP are utilised as required and implementation of appropriate dust controls are triggered by a range of methods, including:

- Dust monitoring results, indicating an elevated level of dust beyond the site boundary;
- Site inspections and observation of visible dust plumes; and
- Meteorological data from the Pit Top weather station.

Clarence Colliery operates in accordance with the Trigger Action Response Plan (TARP) provided in **Section 5.2** of the AQGHGMP.

Dust monitoring

DA 504-00 specifies dust criteria for Clarence Colliery but does not nominate dust monitoring locations. Condition M2.2 of EPL 726 specifies the monitoring requirements. Current dust monitoring consists of:

- three dust deposition gauges, collected monthly; and
- Co-located PM₁₀ and TSP real-time monitors, operating over two months of a calendar year.

Clarence Colliery has operated this dust monitoring program for several years. A review of this dust monitoring network was undertaken in 2015. The aim of this review was to identify methods to improve the efficiency and value provided from the dust monitoring network. The review considered:

- changes in the regulatory requirements;
- changes in operations and predicted dust impacts from environmental assessments;
- long term trends in monitoring data from Annual Reviews and monthly monitoring reports; and
- complaints relating to air quality.

A detailed discussion around the rationalisation of the dust monitoring network is provided in *Centennial Western Region Environmental Monitoring Rationalisation, Review and Recommendations* (GHD 2015).

The short term and long term monitoring programs are outlined below. The timing to implement the long term monitoring program depends on many factors, such as regulatory approvals, landholder consultation, procurement of equipment and installation.

Short term

The short term monitoring program will remain unchanged from what is currently undertaken. Clarence Colliery has three depositional dust gauges, all located on Centennial-owned land in vicinity of the surface operations. These dust gauges have been operational since 2005.

Real-time monitoring, used to measure PM₁₀ and TSP, commenced in 2010 at a location representative of the nearest neighbour. The Thomson Environmental System (TES) monitoring equipment is a portable unit that operates over two month-long sampling campaigns, separated by at least three months throughout the year. The TES systems record ambient concentrations of PM₁₀ and TSP.

The short term dust monitoring network is shown in **Figure 1**.

Long term

The long term dust monitoring locations remain unchanged from current locations.

No change is made for dust deposition gauges.

Concerning the co-located TSP and PM₁₀ monitoring:

- Historical data for daily PM₁₀ monitoring is consistently well below the criterion.
- The annual average TSP is consistently well below the criterion. Monitoring and modelling data indicates that the risk of the TSP criterion being exceeded is extremely low.
- Having established a consistent TSP to PM₁₀ ratio over several annual cycles, the TSP measurements may be removed.
- The ratio between TSP and PM₁₀ concentrations has been calculated from long term monitoring data to be **0.4**. The measured PM₁₀ annual average would therefore be divided by **0.4** to estimate the annual average TSP concentration³.

The long term dust monitoring network will therefore consist of three dust deposition gauges and one real-time unit with PM₁₀ inlet.

This PM₁₀ real-time unit will be configured to operate continuously (rather than for only two months of the year), in line with the overall strategy to better utilise real-time monitoring for dust management.

The long term dust monitoring network is shown in **Figure 2**.

This Management Plan forms part of the consultation process for moving from the short term monitoring program to the long term monitoring program. This management plan will need to be approved prior to the site moving to the long term monitoring program. If the long term monitoring program is different to what is detailed in an EPL. Then an EPL variation will also be sought prior to moving to the long term monitoring program.

A summary of the dust monitoring to be undertaken at Clarence Colliery is provided in **Table 2** and **Table 3**.

³ Average ratio of PM₁₀ to TSP calculated over monitoring data from annual summary 2010 to 2015.

Table 2 - Clarence Colliery short term dust monitoring locations

Site ID	X (m)	Y (m)	Parameter	Instrument	Frequency	Purpose
DG1	244276	6293167	Dust deposition	DDG	Monthly	Compliance
DG2	244270	6294532	Dust deposition	DDG	Monthly	Background
DG3	243727	6293408	Dust deposition	DDG	Monthly	Compliance
Real-time	244276	6293167	PM ₁₀	TES	2 x month-long sampling campaigns.	Compliance
Real-time	244276	6293167	TSP	TES	2 x month-long sampling campaigns.	Compliance

Notes:

Background – the monitoring site is representative of ‘background’ levels since it is remote from dust generating activities.

Compliance – the monitoring site is at a sensitive receiver location and therefore used for compliance purposes.

Table 3 - Clarence Colliery long term dust monitoring locations

Site ID	X (m)	Y (m)	Parameter	Instrument	Frequency	Purpose
DG1	244276	6293167	Dust deposition	DDG	Monthly	Compliance
DG2	244270	6294532	Dust deposition	DDG	Monthly	Background
DG3	243727	6293408	Dust deposition	DDG	Monthly	Compliance
Real-time	244276	6293167	PM ₁₀	Real-time monitor	Continuous	Compliance

Notes:

Background – the monitoring site is representative of ‘background’ levels since it is remote from dust generating activities. Compliance – the monitoring site is at a sensitive receiver location and therefore used for compliance purposes.

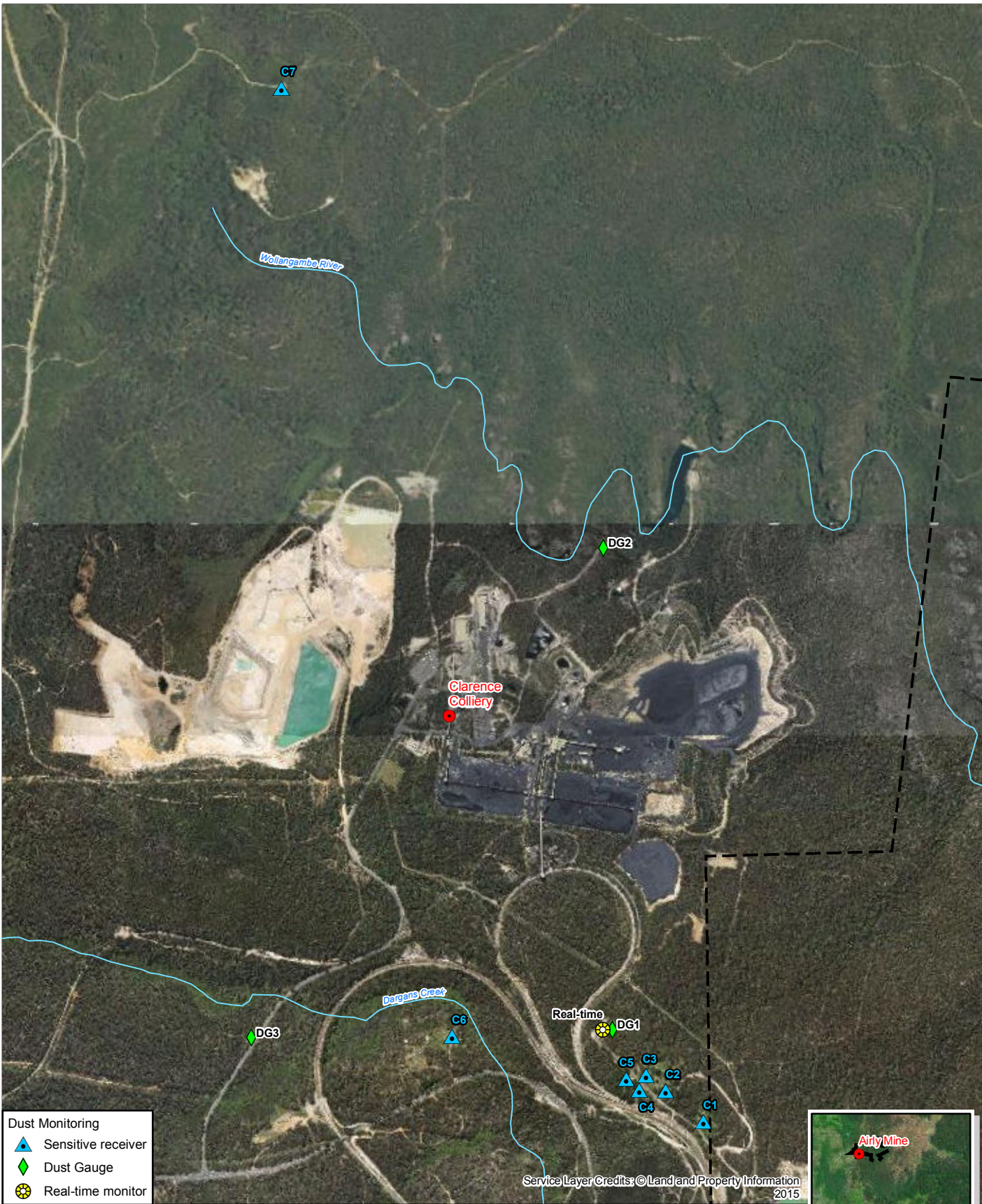

Dust Monitoring	
	Sensitive receiver
	Dust Gauge
	Real-time monitor

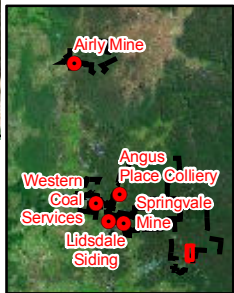

1:15,000 for A4
 0 0.1 0.2 0.3 0.4
 Kilometres
 Map Projection: Universal Transverse Mercator
 Horizontal Datum: Geodetic Datum of Australia 1994
 Grid: Map Grid of Australia, Zone 56

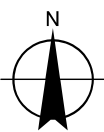

LEGEND
 Centennial Site Location
 Colliery Holding Boundary
 Watercourse

<small>© 2017. Whilst every care has been taken to prepare this map, GHD, NSW Office of Water and ESRI make no representations or warranties about its accuracy, reliability, completeness or suitability for any particular purpose and cannot accept liability and responsibility of any kind (whether in contract, tort or otherwise) for any expenses, losses, damages and/or costs (including indirect or consequential damage) which are or may be incurred by any party as a result of the map being inaccurate, incomplete or unsuitable in any way and for any reason.</small>	LOCATION	-
	SEAM	NA
	DRAWN	F.Mackay
	CHECKED	T.G
	APPROVED	LH
	SCALE	Refer to scalebar

**Centennial Western Region
 Environmental Monitoring**
**Clarence
 Short Term Dust Monitoring**



**Centennial
 Coal**

DATE 9/03/2017

Figure 1



Dust Monitoring	
	Sensitive receiver
	Dust Gauge
	Real-time monitor

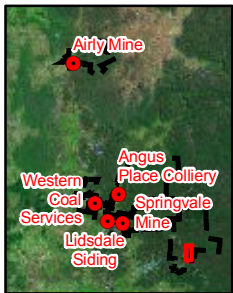

1:15,000 for A4
 0 0.1 0.2 0.3 0.4
 Kilometres
 Map Projection: Universal Transverse Mercator
 Horizontal Datum: Geodetic Datum of Australia 1994
 Grid: Map Grid of Australia, Zone 56

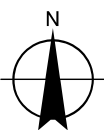

- LEGEND**
- Centennial Site Location
 - Colliery Holding Boundary
 - Watercourse

<small>© 2017. Whilst every care has been taken to prepare this map, GHD, NSW Office of Water and ESRI make no representations or warranties about its accuracy, reliability, completeness or suitability for any particular purpose and cannot accept liability and responsibility of any kind (whether in contract, tort or otherwise) for any expenses, losses, damages and/or costs (including indirect or consequential damage) which are or may be incurred by any party as a result of the map being inaccurate, incomplete or unsuitable in any way and for any reason.</small>	LOCATION	-
	SEAM	NA
	DRAWN	F.Mackay
	CHECKED	T.G
	APPROVED	LH
	SCALE	Refer to scalebar

**Centennial Western Region
 Environmental Monitoring**

**Clarence
 Long Term Dust Monitoring**



**Centennial
 Coal**

DATE 9/03/2017 Figure 2

Meteorological monitoring

Meteorological data for Clarence Colliery is measured from the Pit Top weather station in accordance with EPL 726.

The following parameters are required to be monitored:

- Temperature;
- wind speed and direction;
- Sigma-theta; and
- rainfall/humidity.

The ALS Global web portal has a link to “CLAWS001 Clarence Colliery WS”. The required parameters are measured with addition of pressure, solar radiation and a secondary temperature at 10 m. Derived parameters make use of the data logger capability (Campbell Scientific CR1000) for sigma-theta and evapo-transpiration estimate “ETo ASCE calc”.

Monitoring parameter are summarised in **Table 4**.

Table 4 - Clarence Colliery meteorological monitoring

Site ID	X (m)	Y (m)	Parameter	Instrument	Frequency	Purpose
Clarence Colliery Pit Top	243874	6294261	Temperature Humidity Barometric Pressure Wind – speed and direction Rainfall Solar radiation Sigma-theta	Automatic weather station	10 minute data intervals	Proactive monitoring Weather analysis during noise monitoring Rainfall information

Greenhouse Gas

GHG management and monitoring procedures are documented in **Section 3.2.2** of the AQGHGMP. There are no specific management or monitoring requirements for GHG at Clarence Colliery.

Appendix D – Lidsdale Siding

Conditions of Consent – Lidsdale Siding (MP 08_0223)

This Air Quality and Greenhouse Gas Management Plan has been prepared to satisfy the conditions of consent for the Lidsdale Siding (PA 08_0223). The conditions of consent that relate to this Air Quality and Greenhouse Gas Management Plan and where they have been addressed is provided below.

Table 1 - Conditions of Consent – Lidsdale Siding

Condition No.	Condition of Consent	Where Addressed
Schedule 3 Condition 9	The proponent shall:	
Schedule 3 Condition 9 (a)	Implement best practice air quality management on site, including all reasonable and feasible measures to minimise any visible air pollution generated by the project;	Section 3.1 Appendix D
Schedule 3 Condition 9 (b)	Minimise any visible air pollution generated by the project	Section 3.1 Appendix D
Schedule 3 Condition 9 (c)	Install and operate equipment capable of applying water to the surface of coal loaded onto trains prior to leaving the site;	Appendix D
Schedule 3 Condition 9 (d)	Regularly assess the air quality monitoring results to ensure compliance with the relevant conditions of this approval; To the satisfaction of the Director-General	Section 4.6
Schedule 3 Condition 10	The Proponent shall prepare and implement an Air Quality & Greenhouse Gas Management Plan for the project to the satisfaction of the Director-General.	This Air Quality and Greenhouse Gas Management Plan was originally submitted to the DPE on 11 February 2016 and approved by the Secretary on 22 July 2016. The Management Plan was revised and resubmitted to the DPE on 28 April 2017.
	This plan must:	

Condition No.	Condition of Consent	Where Addressed
Schedule 3 Condition 10(a)	be prepared in consultation with the EPA, and submitted to the Director-General within 6 months of the date of this Approval;	<p>This Air Quality and Greenhouse Gas Management Plan was prepared in consultation with the EPA. A consultation log is provided as Appendix H.</p> <p>This Air Quality and Greenhouse Gas Management Plan was originally submitted to the DPE on 11 February 2016 and approved by the Secretary on 22 July 2016.</p> <p>The Management Plan was revised and resubmitted to the DPE on 28 April 2017.</p>
Schedule 3 Condition 10(b)	describe the measures that would be implemented to ensure compliance with the relevant conditions of this approval;	Section 3.1 Appendix D
Schedule 3 Condition 10(c)	include an air quality monitoring program that:	
	uses a combination of volumetric sampling and dust deposition gauges to evaluate the performance of the project;	Appendix D
	monitors greenhouse gas emissions, and	Section 3.2.2
	includes a protocol for determining exceedances with the relevant conditions of this approval;	Section 4.5
Schedule 3 Condition 10(d)	describe the measures that would be implemented to minimise the release of greenhouse gas emissions from the site.	Section 3.1.2

Overview

The sections below provide site specific information which supplements the information provided in the AQGHGMP around 'common' dust sources, mitigation and management measures.

Site specific sources of dust are identified. Dust mitigation and management measures which are specific to Lidsdale Siding operations are also outlined and discussed.

The dust monitoring network around Lidsdale Siding is also outlined. As discussed in the AQGHGMP, a short term and long term approach has been taken when preparing the dust monitoring program for Centennial operations. The short term monitoring has been prepared to satisfy the existing regulatory requirements for Lidsdale Siding. The long term program has been prepared as part of the regional management plan and may require a transitional period where changes from short term and long term are discussed with the relevant authorities, finalised and implemented.

Site specific dust sources

The following identified sources of dust emissions in the AQGHGMP are relevant for Lidsdale Siding operations:

- Wind erosion from coal stockpiles;
- Wind erosion from disturbed areas and coal stockpiles;
- Wheel generated dust from vehicle movements;
- Fugitive emissions from coal handling and processing
- Fugitive emissions during train loading operations.
- Coal transporting activities (i.e. conveyors and trains).
- Operation of mobile equipment.

There are no additional sources of dust specifically identified for Lidsdale Siding operations.

Site specific dust mitigation and management measures

Lidsdale Siding implements dust mitigation in accordance with the mitigation measures outlined in **Section 3.1** of the AQGHGMP.

Key dust mitigation measures for Lidsdale Siding operations include:

- Signage to display speed limits on all unsealed roads in the surface facilities area;
- Water sprays on unsealed areas during use or windy conditions;
- Water sprays (sprinkler system) on the coal product stockpile during dry and windy conditions; and
- Maintaining enclosures on conveyor systems.

All mitigation measures identified in the AQGHGMP are utilised as required and implementation of appropriate dust controls are triggered by a range of methods, including:

- Dust monitoring results, indicating an elevated level of dust beyond the site boundary;
 - Site inspections and observation of visible dust plumes; and
-

- Meteorological data from the Lidsdale Siding weather station, indicating a high wind event.

Lidsdale Siding operates in accordance with the Trigger Action Response Plan (TARP) provided in **Section 5.2** of the AQGHGMP.

Dust monitoring

The Condition of Consent specifies dust criteria for Lidsdale Siding but does not nominate dust monitoring locations. Condition P1.1 of EPL 5129 specifies monitoring locations.

The existing dust monitoring network at Lidsdale Siding consists of:

- Seven dust deposition gauges, collected monthly; and
- One real-time PM₁₀ monitor, operating continuously (shared with Springvale Mine as a 'regional' monitor).

Lidsdale Siding has operated this dust monitoring program for several years. Significant changes to site operations occurred during 2014 when operations became automated. This generally resulted in a reduction of dust generation from site.

A review of the dust monitoring network was undertaken in 2015. The aim of this review was to identify methods to improve the efficiency and value provided from the dust monitoring network. The review considered:

- changes in the regulatory requirements;
- changes in operations and predicted dust impacts from environmental assessments;
- long term trends in monitoring data from Annual Reviews and monthly monitoring reports; and
- complaints relating to air quality.

A detailed discussion around the rationalisation of the dust monitoring network is provided in *Centennial Western Region Environmental Monitoring Rationalisation, Review and Recommendations* (GHD 2015).

The short term and long term monitoring programs are outlined below. The timing to implement the long term monitoring program depends on many factors, such as regulatory approvals, landholder consultation, procurement of equipment and installation.

Short term

The short term monitoring program will remain unchanged from what is currently undertaken, with the exception of removing D11.

Six dust deposition gauges will be used, located within and around the site. Dust gauges are typically located at, or in the direction of sensitive receivers in order to demonstrate compliance with the dust deposition criterion.

DG11 was determined to not add value over DG10 and is not required on EPL 5129, and therefore has been removed from the network.

The short term dust monitoring network is shown in **Figure 1**.

Long term

The long term dust monitoring locations have been selected based on the rationalisation of the short term monitoring network.

Dust gauge DG1 was determined to add little value to the dust monitoring network and did not have ability to determine compliance at a sensitive receptor location. This gauge will be removed.

The long term dust monitoring network will therefore consist of five dust deposition gauges (DG6, DG7, DG8, DG9 and DG10). A real-time PM₁₀ monitoring station will be relocated to the northeast of Lidsdale Siding (near DG9) as part of the Springvale Mine monitoring network.

The long term dust monitoring network is shown in **Figure 2**.

This Management Plan forms part of the consultation process for moving from the short term monitoring program to the long term monitoring program. This management plan will need to be approved prior to the site moving to the long term monitoring program. If the Long term monitoring program is different to what is detailed in an EPL, then an EPL variation will also be sought prior to moving to the long term monitoring program.

A summary of the dust monitoring to be undertaken at Lidsdale Siding is provided in **Table 2** and **Table 3**.

Table 2 - Lidsdale Siding short term dust monitoring locations

Site ID	X (m)	Y (m)	Parameter	Instrument	Frequency	Purpose
DG1	227359	6300158	Dust deposition	DDG	Monthly	Ambient
DG6	227868	6300339	Dust deposition	DDG	Monthly	Ambient
DG7	227763	6300645	Dust deposition	DDG	Monthly	Ambient
DG8	228162	6300585	Dust deposition	DDG	Monthly	Ambient
DG9	228351	6301038	Dust deposition	DDG	Monthly	Compliance
DG10	226969	6300072	Dust deposition	DDG	Monthly	Compliance/ background
Real-time	228021	6300767	PM ₁₀	Real-time monitor	Continuous	Compliance and Proactive management

Notes:

Ambient – the monitoring equipment is not at a sensitive receptor location. This monitoring location was selected to provide information regarding dust levels close to sources such as haul roads, ventilation fans or surface operations.

Background – the monitoring site is representative of ‘background’ levels since it is remote from dust generating activities.

Compliance – the monitoring site is at a sensitive receptor location and therefore used for compliance purposes.

Table 3 - Lidsdale Siding long term dust monitoring locations

Site ID	X (m)	Y (m)	Parameter	Instrument	Frequency	Purpose
DG6	227868	6300339	Dust deposition	DDG	Monthly	Ambient
DG7	227763	6300645	Dust deposition	DDG	Monthly	Ambient
DG8	228162	6300585	Dust deposition	DDG	Monthly	Ambient
DG9	228351	6301038	Dust deposition	DDG	Monthly	Compliance
DG10	226969	6300072	Dust deposition	DDG	Monthly	Compliance/ background

Notes:

Ambient – the monitoring equipment is not at a sensitive receptor location. This monitoring location was selected to provide information regarding dust levels close to sources such as haul roads, ventilation fans or surface operations.

Background – the monitoring site is representative of ‘background’ levels since it is remote from dust generating activities.

Compliance – the monitoring site is at a sensitive receptor location and therefore used for compliance purposes.



Dust Monitoring

- Sensitive receiver
- Dust Gauge
- Real-time monitor

Service Layer Credits: © Land and Property Information 2015

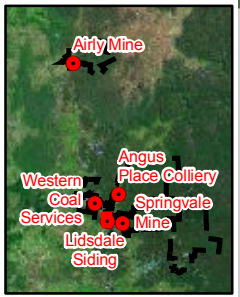

1:12,000 for A4

0 0.1 0.2 0.3 0.4
Kilometres

Map Projection: Universal Transverse Mercator
Horizontal Datum: Geodetic Datum of Australia 1994
Grid: Map Grid of Australia, Zone 56

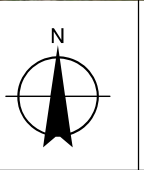

LEGEND

- Centennial Site Location
- Watercourse

LOCATION	-
SEAM	NA
DRAWN	F.Mackay
CHECKED	T.G
APPROVED	LH
SCALE	Refer to scalebar

**Centennial Western Region
Environmental Monitoring**

**Lidsdale Siding
Short Term Dust Monitoring**



**Centennial
Coal**

DATE	9/03/2017	Figure 1
------	-----------	----------



Dust Monitoring

- Sensitive receiver
- Dust Gauge
- Real-time monitor

Service Layer Credits: © Land and Property Information 2015

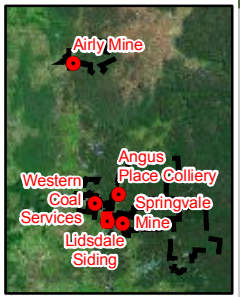

1:12,000 for A4

0 0.1 0.2 0.3 0.4
Kilometres

Map Projection: Universal Transverse Mercator
Horizontal Datum: Geodetic Datum of Australia 1994
Grid: Map Grid of Australia, Zone 56

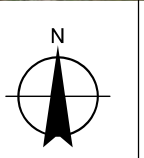

LEGEND

- Centennial Site Location
- Watercourse

LOCATION	-
SEAM	NA
DRAWN	F.Mackay
CHECKED	T.G
APPROVED	LH
SCALE	Refer to scalebar

**Centennial Western Region
Environmental Monitoring**

**Lidsdale Siding
Long Term Dust Monitoring**



DATE	9/03/2017	Figure 2
------	-----------	----------

Meteorological monitoring

Meteorological data for Lidsdale Siding is managed by contractor and available through the ALS Global web portal as 'LSAWS001 AWS at Lidsdale'.

The weather stations continuously monitor weather parameters.

Table 4 - Lidsdale Siding meteorological monitoring

Site ID	X (m)	Y (m)	Parameter	Instrument	Frequency	Purpose
Lidsdale AWS	228019	6300768	Temperature – 2 m and 10 m Wind – speed and direction Rainfall Relative humidity	Automatic weather station	10 minute data intervals	Proactive monitoring. Weather analysis during noise monitoring. Rainfall information

Greenhouse Gas

GHG management and monitoring procedures are documented in **Section 3.2.2** of the AQGHGMP.

There are no specific management or monitoring requirements for GHG at Lidsdale Siding.

Appendix E – Springvale Mine

Conditions of Consent – Springvale Mine (SSD 5594)

This Air Quality and Greenhouse Gas Management Plan has been prepared to satisfy the conditions of consent for the Springvale Mine (SSD 5594). The conditions of consent that relate to this Air Quality and Greenhouse Gas Management Plan and where they have been addressed is provided below.

Table 1 - Conditions of Consent – Springvale Mine

Condition No.	Condition of Consent	Where Addressed
Schedule 4 Condition 7	The Applicant shall prepare and implement an Air Quality Management Plan for the development to the satisfaction of the Secretary.	This Air Quality and Greenhouse Gas Management Plan was approved by the Secretary on 22 July 2016.
	This plan must:	
Schedule 4 Condition 7(a)	be prepared in consultation with the EPA, and submitted to the Secretary within three months of the date of this consent, unless otherwise agreed by the Secretary;	<p>This Air Quality and Greenhouse Gas Management Plan was prepared in consultation with the EPA. A consultation log is provided as Appendix H.</p> <p>This Air Quality and Greenhouse Gas Management Plan was originally submitted to the DPE on 11 February 2016 and approved by the Secretary on 22 July 2016.</p> <p>The Management Plan was revised and resubmitted to the DPE on 28 April 2017.</p>
Schedule 4 Condition 7(b)	describe all reasonable and feasible measures which would be implemented to ensure compliance with the air quality criteria and operating conditions of this consent;	Section 3.1 Appendix E

Condition No.	Condition of Consent	Where Addressed
Schedule 4 Condition 7(c)	describe the air quality management system in detail;	Section 3
Schedule 4 Condition 7(d)	include an air quality monitoring program that:	
	uses monitors to evaluate the performance of the development against the air quality criteria in this consent;	Section 4
	adequately supports the air quality management system;	Section 4 Section 4.5
	evaluates and reports on:	
	the effectiveness of the air quality management system; and	Section 4.5
	compliance with the air quality criteria and operating conditions in condition 6 above;	Section 4.5
	defines what constitutes an air quality incident, and includes a protocol for identifying and notifying the Department and relevant stakeholders of any air quality incidents.	Section 6

Overview

The sections below provide site specific information which supplements the information provided in the AQGHGMP around 'common' dust sources, mitigation and management measures.

Site specific sources of dust are identified. Dust mitigation and management measures which are specific to Springvale Mine operations are also outlined and discussed.

The dust monitoring network around Springvale Mine is also outlined. As discussed in the AQGHGMP, a short term and long term approach has been taken when preparing the dust monitoring program for Centennial operations. The short term monitoring has been prepared to satisfy the existing regulatory requirements for Springvale Mine. The long term program has been prepared as part of the regional management plan and may require a transitional period where changes from short term and long term are discussed with the relevant authorities, finalised and implemented.

Site specific dust sources

The following identified sources of dust emissions in the AQGHGMP are relevant for Springvale Mine operations:

- Wind erosion from coal stockpiles;
- Wind erosion from disturbed areas and coal stockpiles;
- Wheel generated dust from vehicle movements;
- Fugitive emissions from coal handling and processing;
- Fugitive emissions through mine ventilation fans as a result of underground mining operations;
- Coal transporting activities; and
- Operation of mobile equipment.

There are no additional sources of dust specifically identified for Springvale Mine operations.

Site specific dust mitigation and management measures

Springvale Mine implements dust mitigation in accordance with the mitigation measures outlined in **Section 3.1** of the AQGHGMP.

Key dust mitigation measures for Springvale Mine operations include:

- Signage to display speed limits on all unsealed roads in the surface facilities area;
- Water sprays on unsealed areas during use or windy conditions; and
- Water sprays (sprinkler system) on the coal product stockpile as required.

All mitigation measures identified in the AQGHGMP are utilised as required and implementation of appropriate dust controls are triggered by a range of methods, including:

- Dust monitoring results, indicating an elevated level of dust beyond the site boundary;
- Site inspections and observation of visible dust plumes; and
- Meteorological data from the Springvale Mine, indicating a high wind event.

Springvale Mine operates in accordance with the Trigger Action Response Plan (TARP) provided in **Section 5.2** of the AQGHGMP.

Dust monitoring

The Condition of Consent specifies dust criteria for Springvale Mine but does not nominate dust monitoring locations. Condition P1.1 of EPL 3607 specifies a single monitoring location.

The existing dust monitoring network at Springvale Mine consists of:

- Two dust deposition gauges, collected monthly; and
-

- Co-located PM₁₀ and TSP High-Volume monitoring, operating every sixth day.

Springvale Mine has operated this dust monitoring program for several years. A review of this dust monitoring network was undertaken in 2015. The aim of this review was to identify methods to improve the efficiency and value provided from the dust monitoring network. The review considered:

- changes in the regulatory requirements;
- changes in operations and predicted dust impacts from environmental assessments;
- long term trends in monitoring data from Annual Reviews and monthly monitoring reports; and
- complaints relating to air quality.

A detailed discussion around the rationalisation of the dust monitoring network is provided in *Centennial Western Region Environmental Monitoring Rationalisation, Review and Recommendations* (GHD 2015).

The short term and long term monitoring programs are outlined below. The timing to implement the long term monitoring program depends on many factors, such as regulatory approvals, landholder consultation, procurement of equipment and installation.

Short term

The short term monitoring program will remain unchanged from what is currently undertaken. Two dust deposition gauges will be used, one located at the nearest sensitive receiver (S1) and one located near the pit top.

High Volume Air Sampling (HVAS) equipment, used to measure PM₁₀ and TSP, was installed in 2010 at one location to the southwest of the pit top, in the vicinity of the nearest sensitive receiver (S1). The HVAS monitoring equipment operates on a one in six day cycle to record ambient concentrations of PM₁₀ and TSP.

A real-time dust monitor is also in operation, in line with the trend to better utilise real-time monitoring data to enable immediate response and dust mitigation should elevated dust levels be detected.

The real-time monitoring location has been selected to assist in the assessment and management of regional-scale dust impacts.

The short term dust monitoring network is shown in **Figure 1**.

Long term

The long term dust monitoring locations have been selected based on the rationalisation of the short term monitoring network.

Dust gauge DG1 was determined to add little value to the dust monitoring network and did not have ability to determine compliance at a sensitive receptor location. This gauge will be moved to a

sensitive receiver location, where it will also be used to determine compliance and provide information regarding background dust levels at sensitive receiver S4.

Concerning the co-located TSP and PM₁₀ HVAS monitoring:

- Historical data for daily PM10 monitoring is consistently well below the criterion.
- The annual average TSP is consistently well below the criterion. Monitoring and modelling data indicates that the risk of the TSP criterion being exceeded is very low.
- Based on an established low risk of impact, the HVAS equipment will be removed. Short-term dust concentrations will be monitored and management through the real-time monitoring station.
- A consistent TSP to PM10 ratio has been established using HVAS data over several annual cycles. This ratio will be used to estimate the TSP concentration, based on measured PM10 concentrations. The ratio between TSP and PM10 concentrations has been calculated from long term monitoring data to be **0.45**. The measured PM10 annual average would therefore be divided by **0.45** to estimate the annual average TSP concentration⁴.

The long term dust monitoring network will therefore consist of two dust deposition gauges (DG1 and DG2) and one real-time PM₁₀ monitoring station.

The long term dust monitoring network is shown in **Figure 2**.

This Management Plan forms part of the consultation process for moving from the short term monitoring program to the long term monitoring program. This management plan will need to be approved prior to the site moving to the long term monitoring program. If the Long term monitoring program is different to what is detailed in an EPL. Then an EPL variation will also be sought prior to moving to the long term monitoring program.

A summary of the dust monitoring to be undertaken at Springvale Mine is provided in **Table 2** and **Table 3**.

Table 2 - Springvale Mine short term dust monitoring locations

Site ID	X (m)	Y (m)	Parameter	Instrument	Frequency	Purpose
DG1	231004	6300315	Dust deposition	DDG	Monthly	Background
DG2	230197	6299828	Dust deposition	DDG	Monthly	Compliance
HVAS	231002	6299489	PM ₁₀	HVAS	1-in-6 day	Compliance
HVAS	231002	6299489	TSP	HVAS	1-in-6 day	Compliance

⁴ Average ratio of PM₁₀ to TSP calculated over monitoring data from annual summary 2012 to 2015.

Notes:

Background – the monitoring site is representative of ‘background’ levels since it is remote from dust generating activities.

Compliance – the monitoring site is at a sensitive receptor location and therefore used for compliance purposes.

Table 3 - Springvale Mine long term dust monitoring locations

Site ID	X (m)	Y (m)	Parameter	Instrument	Frequency	Purpose
DG1	231589	6299387	Dust deposition	DDG	Monthly	Compliance/ Background
DG2	230240	6299928	Dust deposition	DDG	Monthly	Compliance
Real-time	228553	6300807	PM ₁₀	Real-time monitor	Continuous	Compliance and Proactive management

Notes:

Background – the monitoring site is representative of ‘background’ levels since it is remote from dust generating activities.

Compliance – the monitoring site is at a sensitive receptor location and therefore used for compliance purposes.

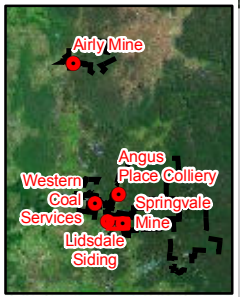

Dust Monitoring	
	Sensitive receiver
	Dust Gauge
	HVAS

1:24,000 for A4

0 0.2 0.4 0.6 0.8
Kilometres

Map Projection: Universal Transverse Mercator
Horizontal Datum: Geodetic Datum of Australia 1994
Grid: Map Grid of Australia, Zone 56

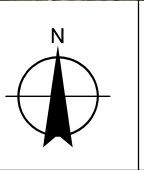

GHD

LEGEND

- Centennial Site Location
- Colliery Holding Boundary
- Watercourse

<small>© 2017. Whilst every care has been taken to prepare this map, GHD, NSW Office of Water and ESRI make no representations or warranties about its accuracy, reliability, completeness or suitability for any particular purpose and cannot accept liability and responsibility of any kind (whether in contract, tort or otherwise) for any expenses, losses, damages and/or costs (including indirect or consequential damage) which are or may be incurred by any party as a result of the map being inaccurate, incomplete or unsuitable in any way and for any reason.</small>	LOCATION	-
	SEAM	NA
	DRAWN	F.Mackay
	CHECKED	T.G
	APPROVED	LH
	SCALE	Refer to scalebar

Centennial Western Region
Environmental Monitoring
Springvale
Short Term Dust Monitoring

Centennial Coal

DATE	9/03/2017	Figure 1
------	-----------	----------



Service Layer Credits: © Land and Property Information 2015

Dust Monitoring

- Sensitive receiver
- Dust Gauge
- Real-time monitor

1:24,000 for A4

0 0.2 0.4 0.6 0.8
Kilometres

Map Projection: Universal Transverse Mercator
Horizontal Datum: Geodetic Datum of Australia 1994
Grid: Map Grid of Australia, Zone 56

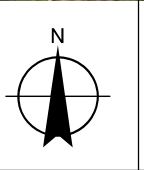

GHD

LEGEND

- Centennial Site Location
- Colliery Holding Boundary
- Watercourse

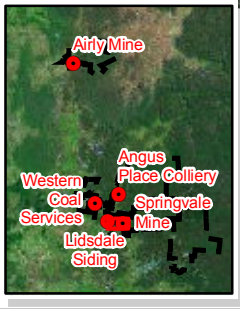

<small>© 2017. Whilst every care has been taken to prepare this map, GHD, NSW Office of Water and ESRI make no representations or warranties about its accuracy, reliability, completeness or suitability for any particular purpose and cannot accept liability and responsibility of any kind (whether in contract, tort or otherwise) for any expenses, losses, damages and/or costs (including indirect or consequential damage) which are or may be incurred by any party as a result of the map being inaccurate, incomplete or unsuitable in any way and for any reason.</small>	LOCATION	-
	SEAM	NA
	DRAWN	F.Mackay
	CHECKED	T.G
	APPROVED	LH
	SCALE	Refer to scalebar

**Centennial Western Region
Environmental Monitoring**

**Springvale
Long Term Dust Monitoring**

Centennial Coal

DATE	9/03/2017	Figure 2
------	-----------	----------

Meteorological monitoring

Meteorological data for Springvale Mine is measured at Springvale AWS, located near the pit top. The weather stations monitors weather parameters summarised in **Table 4**.

In addition, the weather station will be capable of continuous real-time measurement of the atmospheric stability category determined by the sigma theta method in accordance with the NSW Industrial Noise Policy.

Table 4 – Springvale meteorological monitoring

Site ID	X (m)	Y (m)	Parameter	Instrument	Frequency	Purpose
Springvale AWS	230746	6300147	Temperature Wind – speed and direction Rainfall Relative humidity Evaporation	Automatic weather station	10 minute data intervals	Proactive monitoring. Weather analysis during noise monitoring. Rainfall information

Greenhouse Gas

GHG management and monitoring procedures are documented in **Section 3.2.2** of the AQGHGMP.

There are no specific management or monitoring requirements for GHG at Springvale Mine.

Appendix F – Western Coal Services

Conditions of Consent – Western Coal Services (SSD 5579)

This Air Quality and Greenhouse Gas Management Plan has been prepared to satisfy the conditions of consent for the Western Coal Services (SSD 5579). The conditions of consent that relate to this Air Quality and Greenhouse Gas Management Plan and where they have been addressed is provided below.

Table 1 - Conditions of Consent – Western Coal Services

Condition No.	Condition of Consent	Where Addressed
Schedule 3 Condition 15	If particulate matter emissions generated by the development exceed the criteria, or contribute to an exceedance of the relevant cumulative criteria, in Tables 7, 8 or 9, at any residence on privately-owned land, then upon receiving a written request for acquisition from the landowner the Applicant must acquire the land in accordance with the procedures in conditions 5-6 of Schedule 4.	Appendix F
Schedule 3 Condition 16 (a)	The Applicant shall: Implement best practice management to minimise the off-site odour, fume and dust emissions of the development;	Section 3.1.1 & Appendix F
Schedule 3 Condition 16 (b)	Implement all reasonable and feasible measures to minimise the release of greenhouse gas emissions from the site;	Section 3.1.1 & Appendix F
Schedule 3 Condition 16 (c)	Minimise the surface disturbance of the site;	Section 3.1.1 & Appendix F
Schedule 3 Condition 16 (d)	Minimise any offsite air pollution generated by the development	Section 3.1.1 & Appendix F
Schedule 3 Condition 16 (e)	Operate a comprehensive air quality management system that uses a combination of predictive meteorological forecasting, predictive air dispersion modelling and air quality monitoring data to guide the day-to-day planning of coal transportation and processing operations and implementation of both proactive and reactive air quality mitigation measures	Appendix F

Condition No.	Condition of Consent	Where Addressed
	to ensure compliance with the relevant condition of this consent; and	
Schedule 3 Condition 16 (f)	Minimise the air quality impacts of the development during adverse meteorological conditions and extraordinary events (see note d to Tables 7-9), To the satisfaction of the Secretary.	Appendix F
Schedule 3 Condition 17	The Applicant shall prepare and implement an Air Quality Management Plan for the development to the satisfaction of the Secretary.	<p>The original Air Quality and Greenhouse Gas Management Plan was submitted to the Secretary on 4 August 2014. Feedback was received from the DPE on 27 August 2014 and the revised Air Quality and Greenhouse Gas Management Plan was re-submitted on 24 April 2015. No approval has been received.</p> <p>This Air Quality and Greenhouse Gas Management Plan was originally submitted to the DPE on 11 February 2016 and approved by the Secretary on 22 July 2016.</p> <p>The Management Plan was revised and resubmitted to the DPE on 28 April 2017.</p>
Schedule 3 Condition 17(a)	This plan must: be prepared in consultation with the EPA, and submitted to the Secretary for approval within 4 months of the date of this consent, unless otherwise agreed by the Secretary;	This Air Quality and Greenhouse Gas Management Plan was prepared in consultation with the

Condition No.	Condition of Consent	Where Addressed
		<p>EPA. A consultation log is provided as Appendix H.</p> <p>The original Air Quality and Greenhouse Gas Management Plan was submitted to the Secretary on 4 August 2014.</p> <p>This Air Quality and Greenhouse Gas Management Plan was originally submitted to the DPE on 11 February 2016 and approved by the Secretary on 22 July 2016.</p> <p>The Management Plan was revised and resubmitted to the DPE on 28 April 2017.</p>
Schedule 3 Condition 17(b)	describe the measures that would be implemented to ensure compliance with the relevant air quality criteria and operating conditions of this consent;	Section 3.1 Appendix F
Schedule 3 Condition 17I	describe the proposed air quality management system; and	Section 3
Schedule 3 Condition 17(d)	include an air quality monitoring program that:	
	uses a combination of at least one tapered element oscillating microbalance air quality monitor, sited in the vicinity of Blackmans Flat, and supplementary monitors to evaluate the performance of the development against the air quality criteria in this consent;	Section 4 Appendix F
	adequately supports the proactive and reactive air quality management system;	Section 4 Section 4.5
	evaluates and reports on:	

Condition No.	Condition of Consent	Where Addressed
	the effectiveness of the air quality management system; and	Section 4.5
	compliance with the air quality operating conditions; and	Section 4.5
	defines what constitutes an air quality incident, and includes a protocol for identifying and notifying the Department and relevant stakeholders of any air quality incidents.	Section 6

Overview

The sections below provide site specific information which supplements the information provided in the AQGHGMP around 'common' dust sources, mitigation and management measures.

Site specific sources of dust are identified. Dust mitigation and management measures which are specific to Western Coal Services operations are also outlined and discussed.

The dust monitoring network around Western Coal Services is also outlined. As discussed in the AQGHGMP, a short term and long term approach has been taken when preparing the dust monitoring program for Centennial operations. The short term monitoring has been prepared to satisfy the existing regulatory requirements for Western Coal Services. The long term program has been prepared as part of the regional management plan and may require a transitional period where changes from short term and long term are discussed with the relevant authorities, finalised and implemented.

Site specific dust sources

The following identified sources of dust emissions in the AQGHGMP are relevant for Western Coal Services operations:

- Wind erosion from coal stockpiles;
- Wind erosion from disturbed areas and coal stockpiles;
- Wheel generated dust from vehicle movements;
- Fugitive emissions from coal handling and processing;
- Coal transporting activities (i.e. conveyors and trains); and
- Operation of mobile equipment.

There are no additional sources of dust specifically identified for Western Coal Services operations.

Site specific dust mitigation and management measures

Western Coal Services implements dust mitigation in accordance with the mitigation measures outlined in **Section 3.1** of the AQGHGMP.

Key dust mitigation measures for Western Coal Services operations include:

- Signage to display speed limits on all unsealed roads in the surface facilities area;
- Water sprays on unsealed areas during use or windy conditions;
- Water sprays (sprinkler system) on the coal product stockpile during dry and windy conditions; and
- Maintain covers on conveyors.

All mitigation measures identified in the AQGHGMP are utilised as required and implementation of appropriate dust controls are triggered by a range of methods, including:

- Dust monitoring results, indicating an elevated level of dust beyond the site boundary;
- Site inspections and observation of visible dust plumes; and
- Meteorological data from the Western Coal Services weather station, indicating a high wind event.

Western Coal Services operates in accordance with the Trigger Action Response Plan (TARP) provided in **Section 5.2** of the AQGHGMP.

Dust monitoring

The Condition of Consent specifies dust criteria for Western Coal Services and includes specifics such as the use of *“at least one tapered element oscillating microbalance air quality monitor, sited in the vicinity of Blackmans Flat, and supplementary monitors to evaluate the performance of the development against the air quality criteria in this consent.”*

The existing dust monitoring network at Western Coal Services consists of:

- Three dust deposition gauges, collected monthly; and
- One TEOM real-time dust monitor, operating continuously.

Western Coal Services has operated this dust monitoring program for several years. A review of this dust monitoring network was undertaken in 2015. The aim of this review was to identify methods to improve the efficiency and value provided from the dust monitoring network. The review considered:

- changes in the regulatory requirements;
 - changes in operations and predicted dust impacts from environmental assessments;
 - long term trends in monitoring data from Annual Reviews and monthly monitoring reports; and
 - complaints relating to air quality.
-

A detailed discussion around the rationalisation of the dust monitoring network is provided in *Centennial Western Region Environmental Monitoring Rationalisation, Review and Recommendations* (GHD 2015). The key outcome of this review was identifying the redundancy in data collected from the HVAS shared with Pinedale Mine since the installation of the TEOM in Blackmans Flat. This HVAS provides no additional benefit from the TEOM and has been removed from the monitoring network.

The short term and long term monitoring programs are outlined below.

Short term

The short term monitoring program will remain unchanged from what is currently undertaken. Three dust deposition gauges will be used, as shown in Table 2 and Figure 1. A real-time PM₁₀ dust monitor is also in operation at Blackmans Flat, in line with the trend to better utilise real-time monitoring data to enable immediate response and dust mitigation should elevated dust levels be detected.

Concerning the co-located TSP and PM₁₀ HVAS monitoring (Historically shared with Pinedale Mine):

- Historical data for daily PM₁₀ monitoring is consistently well below the criterion. The real-time monitor provides more useful information for PM₁₀.
- The annual average TSP is consistently well below the criterion. Monitoring and modelling data indicates that the risk of the TSP criterion being exceeded is very low.
- Based on an established low risk of impact, the HVAS equipment was removed. Short-term dust concentrations are monitored and management through the real-time monitoring station.
- A consistent TSP to PM₁₀ ratio has been established using HVAS data over several annual cycles. This ratio is used to estimate the TSP concentration, based on measured PM₁₀ concentrations. The ratio between TSP and PM₁₀ concentrations has been calculated from long term monitoring data to be **0.43**. The measured PM₁₀ annual average would therefore be divided by **0.43** to estimate the annual average TSP concentration⁵.

The short term dust monitoring network is shown in **Figure 1**.

Long term

The long term monitoring network remains unchanged from the short term network.

The long term dust monitoring network is shown in **Figure 2**.

A summary of the dust monitoring to be undertaken at Western Coal Services is provided in **Table 2** and **Table 3**.

Table 2 – Western Coal Services short term dust monitoring locations

Site ID	X (m)	Y (m)	Parameter	Instrument	Frequency	Purpose
DG3	227717	6301228	Dust deposition	DDG	Monthly	Compliance

⁵ Average ratio of PM₁₀ to TSP calculated over monitoring data from annual summary to October 2015.

DG4	225866	6303462	Dust deposition	DDG	Monthly	Ambient
DG5	226532	6304439	Dust deposition	DDG	Monthly	Compliance
Real-time	226422	6304420	PM ₁₀	Real-time monitor	Continuous	Compliance/ Proactive management

Notes:

Ambient – the monitoring equipment is not at a sensitive receptor location. This monitoring location was selected to provide information regarding dust levels close to sources such as haul roads, ventilation fans or surface operations.

Background – the monitoring site is representative of ‘background’ levels since it is remote from dust generating activities.

Compliance – the monitoring site is at a sensitive receptor location and therefore used for compliance purposes.

Table 3 – Western Coal Services long term dust monitoring locations

Site ID	X (m)	Y (m)	Parameter	Instrument	Frequency	Purpose
DG3	227717	6301228	Dust deposition	DDG	Monthly	Compliance
DG4	225866	6303462	Dust deposition	DDG	Monthly	Ambient
DG5	226532	6304439	Dust deposition	DDG	Monthly	Compliance
Real-time	226422	6304420	PM ₁₀	Real-time monitor	Continuous	Compliance/ Proactive management

Notes:

Ambient – the monitoring equipment is not at a sensitive receptor location. This monitoring location was selected to provide information regarding dust levels close to sources such as haul roads, ventilation fans or surface operations.

Background – the monitoring site is representative of ‘background’ levels since it is remote from dust generating activities.

Compliance – the monitoring site is at a sensitive receptor location and therefore used for compliance purposes.

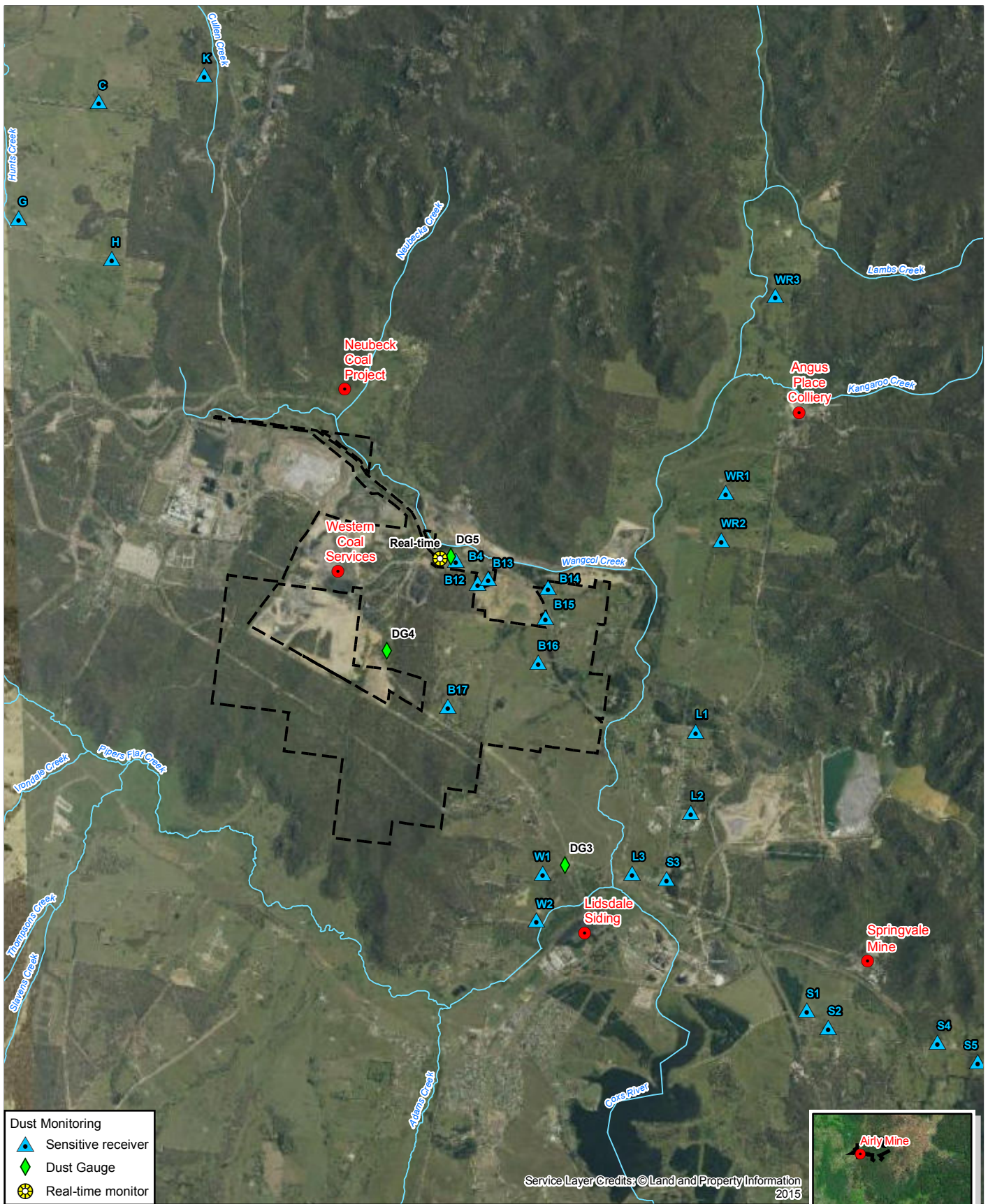

Service Layer Credits: © Land and Property Information 2015

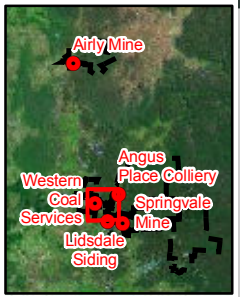

Dust Monitoring	
	Sensitive receiver
	Dust Gauge
	Real-time monitor

1:55,000 for A4

Map Projection: Universal Transverse Mercator
Horizontal Datum: Geodetic Datum of Australia 1994
Grid: Map Grid of Australia, Zone 56

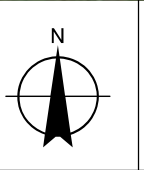

LEGEND

- Centennial Site Location
- Colliery Holding Boundary
- Watercourse

© 2017. Whilst every care has been taken to prepare this map, GHD, NSW Office of Water and ESRI make no representations or warranties about its accuracy, reliability, completeness or suitability for any particular purpose and cannot accept liability and responsibility of any kind (whether in contract, tort or otherwise) for any expenses, losses, damages and/or costs (including indirect or consequential damage) which are or may be incurred by any party as a result of the map being inaccurate, incomplete or unsuitable in any way and for any reason.

LOCATION	-
SEAM	NA
DRAWN	F.Mackay
CHECKED	T.G
APPROVED	LH
SCALE	Refer to scalebar

Centennial Western Region
Environmental Monitoring
Western Coal Services
Short Term Dust Monitoring

Centennial
Coal

DATE	9/03/2017	Figure 1
------	-----------	----------

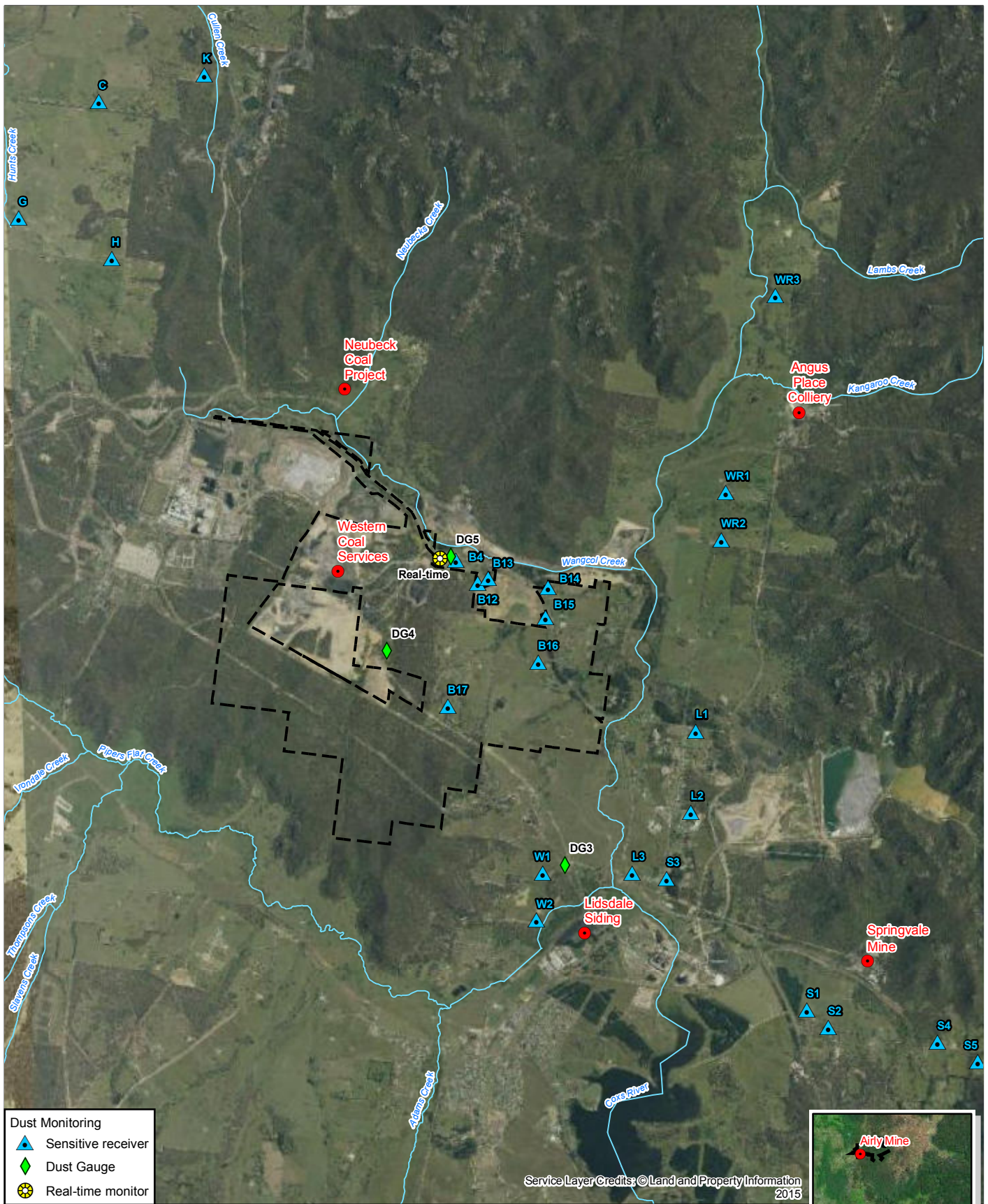

Dust Monitoring

- Sensitive receiver
- Dust Gauge
- Real-time monitor

Service Layer Credits: © Land and Property Information 2015

1:55,000 for A4

Map Projection: Universal Transverse Mercator
Horizontal Datum: Geodetic Datum of Australia 1994
Grid: Map Grid of Australia, Zone 56

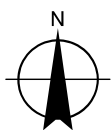

LEGEND

- Centennial Site Location
- Colliery Holding Boundary
- Watercourse

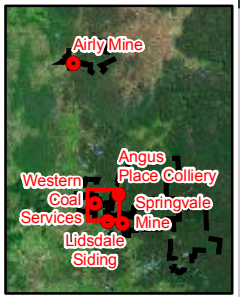

© 2017. Whilst every care has been taken to prepare this map, GHD, NSW Office of Water and ESRI make no representations or warranties about its accuracy, reliability, completeness or suitability for any particular purpose and cannot accept liability and responsibility of any kind (whether in contract, tort or otherwise) for any expenses, losses, damages and/or costs (including indirect or consequential damage) which are or may be incurred by any party as a result of the map being inaccurate, incomplete or unsuitable in any way and for any reason.	LOCATION	-
	SEAM	NA
	DRAWN	F.Mackay
	CHECKED	T.G
	APPROVED	LH
	SCALE	Refer to scalebar

**Centennial Western Region
Environmental Monitoring**

**Western Coal Services
Long Term Dust Monitoring**

Centennial Coal

DATE	9/03/2017	Figure 2
------	-----------	----------

Property Acquisition

If particulate matter emissions generated by the development exceed the criteria, or contribute to an exceedance of the relevant cumulative criteria, at any residence on privately-owned land, then upon receiving a written request for acquisition from the landowner the Applicant must acquire the land in accordance with the procedures in conditions 5-6 of Schedule 4 of the consent. These procedures are outlined below.

Land Acquisition

Schedule 4 Condition 5

Within 3 months of receiving a written request from a landowner with acquisition rights, the Applicant must make a binding written offer to the landowner based on:

- (a) the current market value of the landowner's interest in the land at the date of this written request, as if the land was unaffected by the development, having regard to the:
 - existing and permissible use of the land, in accordance with the applicable planning instruments at the date of the written request; and 21
 - presence of improvements on the land and/or any approved building or structure which has been physically commenced at the date of the landowner's written request, and is due to be completed subsequent to that date, but excluding any improvements that have resulted from the implementation of the additional noise mitigation measures in condition 2 of Schedule 3;
- (b) the reasonable costs associated with:
 - relocating within the Lithgow local government area, or to any other local government area determined by the Secretary; and
 - obtaining legal advice and expert advice for determining the acquisition price of the land, and the terms upon which it is to be acquired; and
- (c) reasonable compensation for any disturbance caused by the land acquisition process.

However, if at the end of this period, the Applicant and landowner cannot agree on the acquisition price of the land and/or the terms upon which the land is to be acquired, then either party may refer the matter to the Secretary for resolution.

Upon receiving such a request, the Secretary will request the President of the NSW Division of the Australian Property Institute to appoint a qualified independent valuer to:

- consider submissions from both parties;
- determine a fair and reasonable acquisition price for the land and/or the terms upon which the land is to be acquired, having regard to the matters referred to in paragraphs (a)-(c) above;
- prepare a detailed report setting out the reasons for any determination; and
- provide a copy of the report to both parties.

Within 14 days of receiving the independent valuer's report, the Applicant must make a binding written offer to the landowner to purchase the land at a price not less than the independent valuer's determination.

However, if either party disputes the independent valuer's determination, then within 14 days of receiving the independent valuer's report, they may refer the matter to the Secretary for review. Any request for a review must be accompanied by a detailed report setting out the reasons why the party disputes the independent valuer's determination. Following consultation with the independent valuer and both parties, the Secretary will determine a fair and reasonable acquisition price for the land, having regard to the matters referred to in paragraphs (a)-(c) above, the independent valuer's report, the detailed report of the party that disputes the independent valuer's determination and any other relevant submissions.

Within 14 days of this determination, the Applicant must make a binding written offer to the landowner to purchase the land at a price not less than the Secretary's determination. If the landowner refuses to accept the Applicant's binding written offer under this condition within 6 months of the offer being made, then the Applicant's obligations to acquire the land shall cease, unless the Secretary determines otherwise.

Schedule 4 Condition 6

The Applicant must pay all reasonable costs associated with the land acquisition process described in condition 5 above, including the costs associated with obtaining LCC approval for any plan of subdivision (where permissible), and registration of this plan at the Office of the Registrar-General.

Meteorological monitoring

Meteorological data for Western Coal Services is monitored at the site Weather station and is linked to an online web portal.

The weather stations continuously monitor weather parameters as summarised in **Table 4**.below.

Table 4 – Western Coal Services meteorological monitoring

Site ID	X (m)	Y (m)	Parameter	Instrument	Frequency	Purpose
Western Coal Services AWS	229275	6302754	Temperature Wind – speed and direction Rainfall Relative humidity Sigma-theta Evaporation	Automatic weather station	10 minute data intervals	Proactive monitoring. Weather analysis during noise monitoring. Rainfall information

Greenhouse Gas

GHG management and monitoring procedures are documented in **Section 3.2.2** of the AQGHGMP.

There are no specific management or monitoring requirements for GHG at Western Coal Services.

Appendix G – Land Ownership Plans

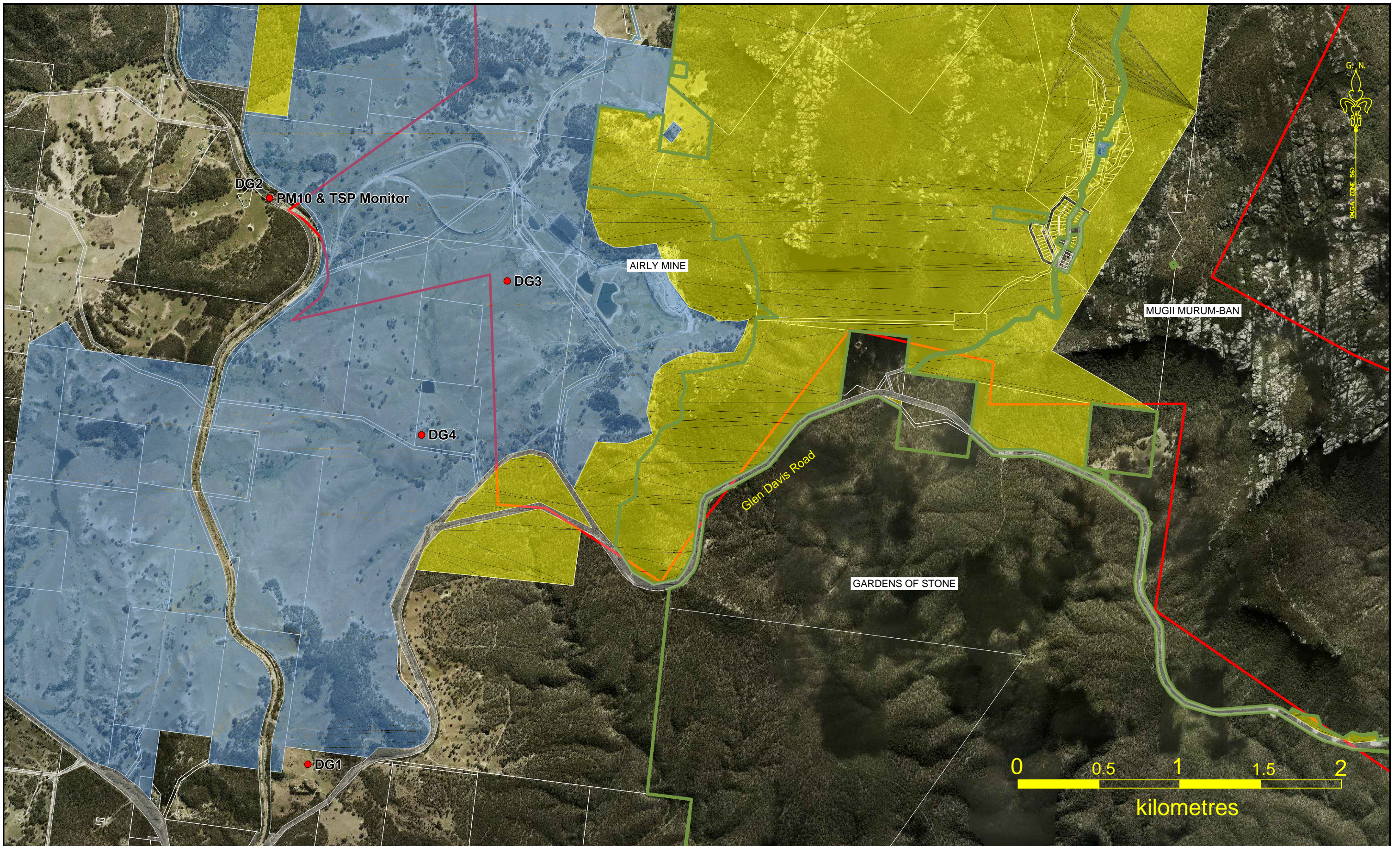

LEGEND

- Air Quality Monitoring Point
- Colliery Holding Boundary
- Centennial Coal Land Parcel
- Crown Land
- Road
- State Conservation Area - National Park

THIS DRAWING IS COPYRIGHT.
 NO PART OF IT MAY IN ANY FORM OR BY ANY
 MEANS (ELECTRONIC, MECHANICAL, MICRO-COPYING,
 PHOTOCOPYING, RECORDING OR OTHERWISE)
 BE REPRODUCED, STORED IN A RETRIEVAL SYSTEM
 OR TRANSMITTED WITHOUT PRIOR WRITTEN PERMISSION.

LOCATION	Airly
SEAM	
DRAWN	C.P.T.
CHECKED	J.W.
APPROVED	P.C.D.
SCALE	Refer to scalebar

Airly Air Quality Monitoring Locations and Land Ownership



Centennial Coal
Fassifem

DATE 18-06-2018

PC6776

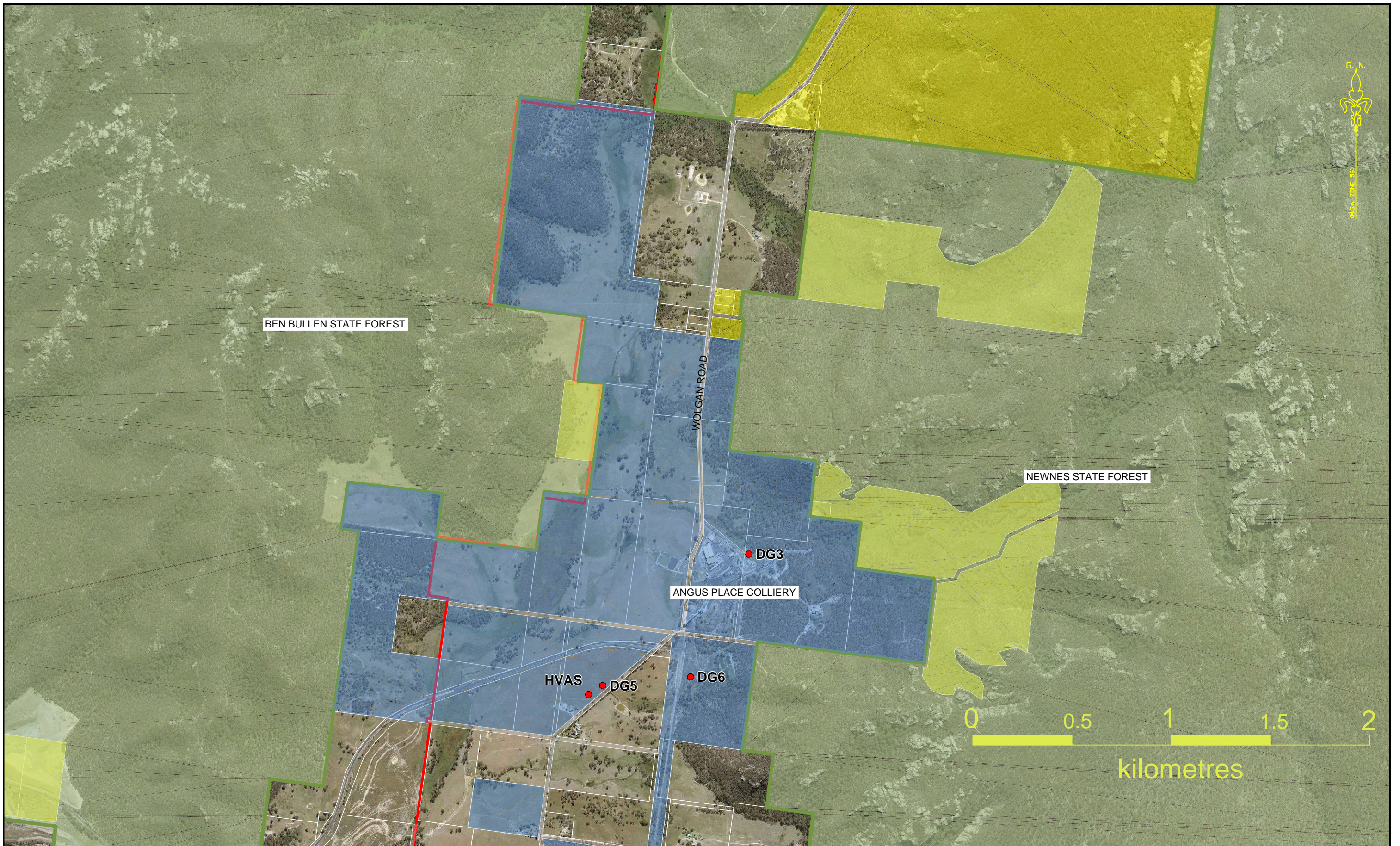

- LEGEND**
- Noise Monitoring Point
 - Colliery Holding Boundary
 - Centennial Coal Land Parcel
 - State Forest Land
 - Road

THIS DRAWING IS COPYRIGHT.
 NO PART OF IT MAY IN ANY FORM OR BY ANY MEANS (ELECTRONIC, MECHANICAL, MICRO-COPYING, PHOTOCOPYING, RECORDING OR OTHERWISE) BE REPRODUCED, STORED IN A RETRIEVAL SYSTEM OR TRANSMITTED WITHOUT PRIOR WRITTEN PERMISSION.

LOCATION	Angus Place
SEAM	
DRAWN	C.P.T.
CHECKED	J.W.
APPROVED	P.C.D.
SCALE	Refer to scalebar

Angus Place Air Quality Monitoring Locations and Land Ownership



DATE 19-06-2018 **PC6776**



- LEGEND**
- Air Quality Monitoring Point
 - Colliery Holding Boundary
 - Centennial Coal Land Parcel
 - National Park
 - Crown Land
 - Road

THIS DRAWING IS COPYRIGHT.
 NO PART OF IT MAY IN ANY FORM OR BY ANY MEANS (ELECTRONIC, MECHANICAL, MICRO-COPYING, PHOTOCOPYING, RECORDING OR OTHERWISE) BE REPRODUCED, STORED IN A RETRIEVAL SYSTEM OR TRANSMITTED WITHOUT PRIOR WRITTEN PERMISSION.

LOCATION	Clarence
SEAM	
DRAWN	C.P.T.
CHECKED	J.W.
APPROVED	P.C.D.
SCALE	Refer to scalebar

Clarence Colliery Air Quality Monitoring Locations and Land Ownership



Centennial Coal
Fassifem

DATE 19-06-2018

PC6778

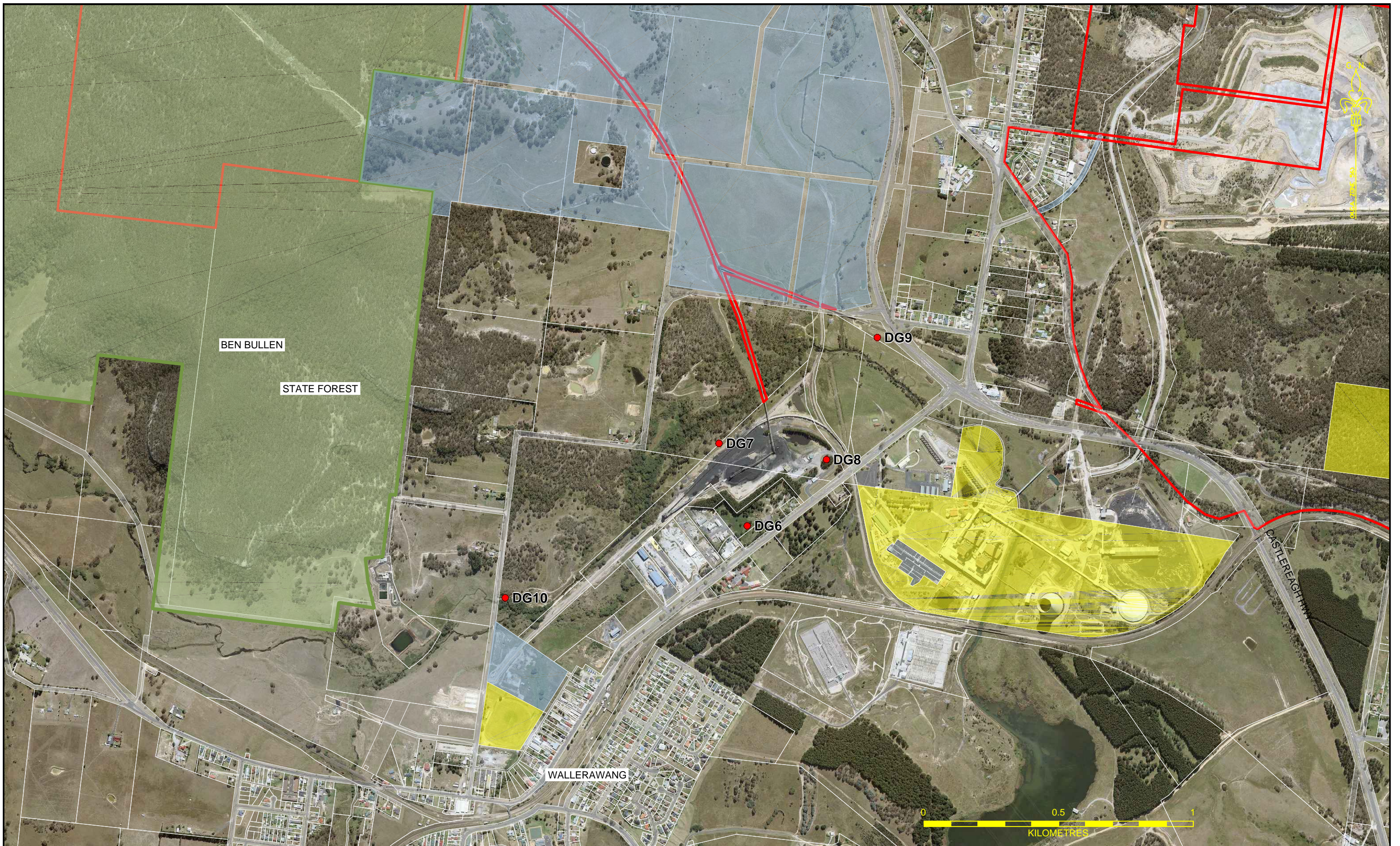

LEGEND

- Noise Monitoring Point
- Colliery Holding Boundary
- Centennial Coal Land Parcel
- State Forest Land
- Road
- Crown Land

THIS DRAWING IS COPYRIGHT.
NO PART OF IT MAY IN ANY FORM OR BY ANY
MEANS (ELECTRONIC, MECHANICAL, MICRO-COPYING,
PHOTOCOPYING, RECORDING OR OTHERWISE)
BE REPRODUCED, STORED IN A RETRIEVAL SYSTEM
OR TRANSMITTED WITHOUT PRIOR WRITTEN PERMISSION.

LOCATION	Lidsdale Siding
SEAM	
DRAWN	C.P.T.
CHECKED	J.W.
APPROVED	P.C.D.
SCALE	Refer to scalebar

Lidsdale Siding Air Quality Monitoring Locations and Land Ownership



Centennial Coal

Fassifem

DATE 19-06-2018

PC6779



- LEGEND**
- Air Quality Monitoring Point
 - Colliery Holding Boundary
 - Centennial Coal Land Parcel
 - State Forest Land
 - Road
 - Crown Land

THIS DRAWING IS COPYRIGHT.
 NO PART OF IT MAY IN ANY FORM OR BY ANY MEANS (ELECTRONIC, MECHANICAL, MICRO-COPYING, PHOTOCOPYING, RECORDING OR OTHERWISE) BE REPRODUCED, STORED IN A RETRIEVAL SYSTEM OR TRANSMITTED WITHOUT PRIOR WRITTEN PERMISSION.

LOCATION	WCS
SEAM	
DRAWN	C.P.T.
CHECKED	J.W.
APPROVED	P.C.D.
SCALE	Refer to scalebar

**Western Coal Services
 Air Quality Monitoring
 Locations and Land Ownership**



DATE 19-06-2018 **PC6774**

Appendix H – Consultation log

Consultation Date	Description
20 October 2015	Letter sent to the Department of Planning and Environment detailing the regional approach to the development of the Air Quality and Greenhouse Gas Management Plan and requesting a 2 month extension to the timeframe for submission.
30 October 2015	Letter sent to the Department of Planning and Environment requesting approval to consolidate the Air Quality and Greenhouse Gas Management Plan into a regional Management Plan.
2 November 2015	Approval received from the Department of Planning and Environment on the 2 month extension to the timeframe for submission with the Management Plan required to be submitted by 21 February 2016.
17 November 2015	Meeting with the EPA (Sydney) discussed regional approach being undertaken for the development of the Management Plans.
19 November 2015	Approval received from the Department of Planning and Environment to consolidate the Management Plans into regional Management Plans.
15 January 2016	Draft Air Quality & Greenhouse Gas Management Plan submitted to the EPA for review and comment
11 February 2016	Final draft Air Quality & Greenhouse Gas Management Plan submitted to the DPE for review and approval
8 July 2016	Re-submission of revised Air Quality & Greenhouse Gas Management Plan to the DPE for review and approval.
22 February 2016	Air Quality & Greenhouse Gas Management Plan approved by the Secretary
10 March 2017	Draft Air Quality & Greenhouse Gas Management Plan submitted to the EPA for review and comment
28 April 2017	Submission of revised Air Quality & Greenhouse Gas Management Plan to the DPE for review and approval.
13 April 2018	Submission of revised Air Quality & Greenhouse Gas Management Plan to the DPE for review and approval.
15 June 2018	Feedback from DPE on the AQ&GHG Management Plan received

22 June 2018	Submission of revised Air Quality & Greenhouse Gas Management Plan to the DPE for review and approval.
--------------	--

Appendix I – Consultation Feedback and Response

Issue Raised	By Whom	How Addressed
<p>Section 5.2 – It is noted that triggers for DDG are the same for orange and red – consider reducing the orange trigger level to prompt proactive actions.</p>	<p>Department of Planning and Environment</p>	<p>No action required.</p> <p>Orange and red triggers for deposited dust are different. Orange triggers for deposited dust are for when monthly monitoring indicates monthly depositional dust levels exceeds the 4 g/m²/month levels or monitoring indicates annual average dust depositional level exceeds 80% of criteria level (3.2 g/m²/month). Red triggers are when annual average levels exceed the criteria of 4 g/m²/month. The current triggers allow a review of the data to occur, and actions implemented if required following orange triggers being recorded to ensure annual average criteria are not exceeded.</p>
<p>4.5 and 6.3 – Confirm that all compliance monitoring sites are located on private land. If located on mine owned land, update the NMP to clearly state that compliance will be assessed at the monitoring location, irrespective of landownership. It is also recommended that Plans included in Appendices show land ownership.</p>	<p>Department of Planning and Environment</p>	<p>Plans showing the location of air quality monitoring locations in relation to landownership have been provided as Appendix G to this Air Quality and Greenhouse Gas Management Plan. Section 4.5 of this management plan has been updated to clarify that where air quality compliance monitoring is undertaken on Centennial owned land,</p>

Issue Raised	By Whom	How Addressed
		compliance for the relevant sensitive receptors is determined at that monitoring location.