



Preliminary Hazard Analysis
813 Wallgrove Road, Horsley Park

DHL Supply Chain (Australia) Pty Ltd
Document No. RCE-21225_DHL_PHA_Final_2Feb22_Rev(0)
Date 2/02/2022

Preliminary Hazard Analysis

813 Wallgrove Road, Horsley Park

DHL Supply Chain (Australia) Pty Ltd

Prepared by

Riskcon Engineering Pty Ltd

Unit 618/159 Ross Street

Forest Lodge, NSW 2037

www.riskcon-eng.com

ABN 74 626 753 820

© Riskcon Engineering Pty Ltd. All rights reserved.

This report has been prepared in accordance with the scope of services described in the contract or agreement between Riskcon Engineering Pty Ltd and the Client. The report relies upon data, surveys, measurements and results taken at or under the particular times and conditions specified herein. Changes to circumstances or facts after certain information or material has been submitted may impact on the accuracy, completeness or currency of the information or material. This report has been prepared solely for use by the Client. Riskcon Engineering Pty Ltd accepts no responsibility for its use by other parties without the specific authorization of Riskcon Engineering Pty Ltd. Riskcon Engineering Pty Ltd reserves the right to alter, amend, discontinue, vary or otherwise change any information, material or service at any time without subsequent notification. All access to, or use of, the information or material is at the user's risk and Riskcon Engineering Pty Ltd accepts no responsibility for the results of any actions taken on the basis of information or material provided, nor for its accuracy, completeness or currency.

Quality Management

| Rev | Date | Remarks | Prepared By | Reviewed By |
|-----|------------------|-------------------------|---------------|-----------------|
| A | 31 December 2021 | Draft issue for comment | Renton Parker | Steve Sylvester |
| 0 | 2 February 2022 | Issued Final | | |

Executive Summary

Background

DHL Supply Chain (Australia) Pty Ltd (DHL) has proposed to store materials classified as Dangerous Goods (DG) within a warehouse at 813 Wallgrove Road, Horsley Park. Where DGs are stored the site is subject to the State Environmental Planning Policy No. 33 (SEPP 33, Ref. [1]) which aims to assess the risk posed by the site upon the adjacent land uses. The proposed quantities to be stored would exceed the SEPP 33 thresholds; hence, it is necessary to assess the risks posed in the form of a Preliminary Hazard Analysis (PHA) in accordance with the Hazardous Industry Planning Advisory Paper (HIPAP) No. 4 and No. 6 (Ref. [2] & [3]) for submission with the Development Application (DA).

DHL has commissioned Riskcon Engineering Pty Ltd (Riskcon) to prepare the PHA for the facility. This document represents the PHA study for the DHL site located at 813 Wallgrove Road, Horsley Park.

Conclusions

A hazard identification table was developed for the warehouse facility to identify potential hazards that may be present at the site as a result of operations or storage of materials. Based on the identified hazards, scenarios were postulated that may result in an incident with a potential for offsite impacts. Postulated scenarios were discussed qualitatively and any scenarios that would not impact offsite were eliminated from further assessment. Scenarios not eliminated were then carried forward for consequence analysis.

Incidents carried forward for consequence analysis were assessed in detail to estimate the impact distances. Impact distances were developed into scenario contours and overlaid onto the site layout diagram to determine if an offsite impact would occur. The consequence analysis showed that one of the scenarios (full warehouse fire) would impact over the site boundary and into the adjacent land use; hence, this incident was carried forward for frequency analysis and risk assessment.

The frequency analysis and risk assessment showed that the full warehouse fire would have a fatality risk of 7.06 chances per million per year (pmpy) at the site boundary, with lesser risk at further distances from the boundary. HIPAP No. 4 (Ref. [2]) publishes acceptable risk criteria at the site boundary of 50 pmpy (for industrial sites). Therefore, the probability of a fatality from a full warehouse fire at the site boundary is within the acceptable risk criteria.

In addition, the only incident which may result in impacts to adjacent structures was a full warehouse fire. Due to the fire size there will be considerable smoke emitted which would obscure the flame surface reducing the average surface emissive power (SEP) and subsequently it would not exceed 23 kW/m². In addition, the distance to the closest buildings is 23 m which would allow attenuation of radiant heat from of luminous spots and would not result in sustained radiant heat such that propagation to adjacent facilities would occur.

Review of the estate proposal indicates this development is the only contributor to the risk profile; hence, cumulative risk is not a consideration at this stage. The cumulative risk at the site is therefore the reported 7.06 chances pmpy which is below the 50 chances pmpy limit. Therefore, the development does not increase the cumulative risk of the estate to an unacceptable level.

Based on the analysis conducted, it is concluded that the risks at the site boundary are not considered to exceed the acceptable risk criteria; hence, the facility would only be classified as potentially hazardous and would be permitted within the current land zoning for the site.

Recommendations

Notwithstanding the conclusions following the analysis of the facility, the following recommendations have been made:

- The site shall be designed to contain any spills or contaminated water from a fire incident within the boundaries of the site.
- Multiple spill kits be provided around the DG storage areas to ensure spills can be cleaned up immediately following identification.
- The warehouse and/or site boundaries shall be capable of containing 702 m³ which may be contained within the warehouse footprint, site stormwater pipework and any recessed docks or other containment areas that may be present as part of the site design.
- The civil engineers designing the site containment shall demonstrate the design is capable of containing at least 702 m³.
- Where a penstock isolation valve is incorporated into the design, it shall be able to isolate automatically upon fire detection.
- Where a penstock isolation valve is incorporated into the design, it shall be capable to manually operate the isolation valve.
- A storm water isolation point (i.e. penstock isolation valve) shall be incorporated into the design. The penstock shall automatically isolate the storm water system upon detection of a fire (smoke or sprinkler activation) to prevent potentially contaminated liquids from entering the water course.

| | |
|--|----|
| Executive Summary | i |
| 1.0 Introduction | 1 |
| 1.1 Background | 1 |
| 1.2 Objectives | 1 |
| 1.3 Scope of Services | 1 |
| 2.0 Methodology | 2 |
| 2.1 Multi-Level Risk Assessment | 2 |
| 2.2 Risk Assessment Study Approach | 3 |
| 3.0 Site Description | 4 |
| 3.1 Site Location | 4 |
| 3.2 Adjacent Land Uses | 4 |
| 3.3 Site Description | 4 |
| 3.4 Quantities of Dangerous Goods Stored and Handled | 5 |
| 3.5 Aggregate Quantity Ratio | 5 |
| 4.0 Hazard Identification | 8 |
| 4.1 Introduction | 8 |
| 4.2 Properties of Dangerous Goods | 9 |
| 4.3 Hazard Identification | 9 |
| 4.4 Flammable Liquid or Gas Release, Delayed Ignition and Flash Fire or Explosion | 10 |
| 4.5 Flammable Material Spill, Ignition and Racking Fire | 11 |
| 4.6 LPG Release (from Aerosol), Ignition and Racking Fire | 11 |
| 4.7 Full Warehouse Fire and Radiant Heat | 12 |
| 4.8 Full Warehouse Fire and Toxic Smoke Emission | 12 |
| 4.9 Dangerous Goods Liquid Spill, Release and Environmental Incident | 12 |
| 4.10 Warehouse Fire, Sprinkler Activation and Potentially Contaminated Water Release | 13 |
| 5.0 Consequence Analysis | 14 |
| 5.1 Incidents Carried Forward for Consequence Analysis | 14 |
| 5.2 Flammable Material Spill, Ignition and Racking Fire | 14 |
| 5.3 LPG Release (from Aerosol), Ignition and Racking Fire | 15 |
| 5.4 Full Warehouse Fire and Radiant Heat | 16 |
| 5.5 Full Warehouse Fire and Toxic Smoke Emission | 18 |
| 6.0 Frequency Analysis | 20 |
| 6.1 Incidents Carried Forward for Frequency Analysis | 20 |
| 6.2 Probability of Failure on Demand | 20 |
| 6.3 Full Warehouse Fire Frequency and Risk Assessment | 20 |
| 6.4 Full Warehouse Fire and Toxic Smoke Emission Frequency and Risk Assessment | 21 |
| 6.5 Total Fatality Risk | 21 |
| 6.6 Comparison Against Risk Criteria | 22 |
| 6.7 Cumulative Assessment | 22 |
| 7.0 Conclusion and Recommendations | 23 |
| 7.1 Conclusions | 23 |
| 7.2 Recommendations | 23 |
| 8.0 References | 25 |
| A1. Hazard Identification Table | 27 |
| B1. Incidents Assessed in Detailed Consequence Analysis | 30 |
| B2. Gexcon - Effects | 30 |
| B3. Radiant Heat Physical Impacts | 30 |
| B4. Flammable Material Spill, Ignition and Racking Fire | 30 |
| B5. LPG Release (From Aerosol), Ignition and Racking Fire | 31 |
| B6. Full Warehouse Fire | 33 |

| | |
|--|----|
| B7. Full Warehouse Fire and Smoke Emission | 33 |
| C1. Estimation of the Frequency of a Full Warehouse Fire | 41 |

List of Figures

| | |
|--|----|
| Figure 2-1: The Multi-Level Risk Assessment Approach | 2 |
| Figure 3-1: Site Location | 4 |
| Figure 3-2: Site Layout | 7 |
| Figure 5-1: Sprinkler Controlled Flammable Material Fire Radiant Heat Contours | 15 |
| Figure 5-2: Sprinkler Controlled Aerosol Fire Radiant Heat Contours | 16 |
| Figure 5-3: Full Warehouse Fire Radiant Heat Contours | 18 |
| Figure 6-1: Full Warehouse Fire Fault Tree | 21 |

List of Tables

| | |
|--|----|
| Table 2-1: Level of Assessment PHA | 2 |
| Table 3-1: Maximum Classes and Quantities of Dangerous Goods Stored | 5 |
| Table 3-2: Major Hazard Facility Thresholds | 6 |
| Table 4-1: Properties* of the Dangerous Goods and Materials Stored at the Site | 9 |
| Table 5-1: Heat Radiation from a Flammable Liquid Racking Fire | 14 |
| Table 5-2: Heat Radiation from an Aerosol Racking Fire | 15 |
| Table 5-3: Radiant Heat Impact Distances from a Full Warehouse Fire | 17 |
| Table 5-4: Full Warehouse Fire Pollutant Release Rates | 19 |
| Table 6-1: Total Fatality Risk | 21 |

List of Appendix Figures

| | |
|--|----|
| Appendix Figure B-2: Heat Radiation and Associated Physical Impacts | 30 |
| Appendix Figure B-3: Flame Height and SEP for a Flammable Material Sprinkler Controlled Fire | 31 |
| Appendix Figure B-4: Heat Radiation from a Flammable Material Sprinkler Controlled Fire | 31 |
| Appendix Figure B-5: Flame Height and SEP for Class 2.1 Sprinkler Controlled Scenarios | 32 |
| Appendix Figure B-6: Heat Radiation from Class 2.1 Sprinkler Controlled Scenarios | 32 |
| Appendix Figure B-7: Full Warehouse Fire Input File | 33 |
| Appendix Figure B-8: Pasquill's Stability Categories | 34 |
| Appendix Figure B-9: Co-ordinate System for Gas Dispersion | 35 |
| Appendix Figure B-10: Input Data for Plume Gaussian Dispersion | 35 |
| Appendix Figure B-11: Pollutant Release Rates | 35 |
| Appendix Figure B-12: Nitrogen Dioxide Downwind Plume Dispersion | 36 |
| Appendix Figure B-13: Sulphur Dioxide Downwind Plume Dispersion | 37 |
| Appendix Figure B-14: Hydrogen Chloride Downwind Plume Dispersion | 38 |
| Appendix Figure B-15: Soot (Carbon) Downwind Plume Dispersion | 39 |

List of Appendix Tables

| | |
|--|----|
| Appendix Table B-1: Flame Height and SEP for an Full Warehouse Fire | 33 |
| Appendix Table B-2: Heat Radiation from an Uncontrolled Main Building Fire | 33 |

Abbreviations

| Abbreviation | Description |
|--------------|--|
| ADG | Australian Dangerous Goods Code |
| AS | Australian Standard |
| CBD | Central Business District |
| CCPS | Centre for Chemical Process Safety |
| DA | Development Application |
| DGs | Dangerous Goods |
| DGS | Dangerous Goods Store |
| DPE | Department of Planning and Environment |
| FRNSW | Fire and Rescue New South Wales |
| HIPAP | Hazardous Industry Planning Advisory Paper |
| HSE | Health and Safety Executive |
| LPG | Liquefied Petroleum Gas |
| PFD | Probability of Failure on Demand |
| PHA | Preliminary Hazard Analysis |
| Pmpy | Per million per year |
| RDC | Retail Distribution Centre |
| SEP | Surface Emissive Power |
| SEPP | State Environmental Planning Policy |
| SMSS | Storage Mode Sprinkler System |

1.0 Introduction

1.1 Background

DHL Supply Chain (Australia) Pty Ltd (DHL) has proposed to store materials classified as Dangerous Goods (DG) within a warehouse at 813 Wallgrove Road, Horsley Park. Where DGs are stored the site is subject to the State Environmental Planning Policy No. 33 (SEPP 33, Ref. [1]) which aims to assess the risk posed by the site upon the adjacent land uses. The proposed quantities to be stored would exceed the SEPP 33 thresholds; hence, it is necessary to assess the risks posed in the form of a Preliminary Hazard Analysis (PHA) in accordance with the Hazardous Industry Planning Advisory Paper (HIPAP) No. 4 and No. 6 (Ref. [2] & [3]) for submission with the Development Application (DA).

DHL has commissioned Riskcon Engineering Pty Ltd (Riskcon) to prepare the PHA for the facility. This document represents the PHA study for the DHL site located at 813 Wallgrove Road, Horsley Park.

1.2 Objectives

The objectives of the PHA project include:

- Complete the PHA according to the Hazardous Industry Planning Advisory Paper (HIPAP) No. 6 – Hazard Analysis (Ref. [3]),
- Assess the PHA results using the criteria in HIPAP No. 4 – Risk Criteria for Land Use Planning (Ref. [1]), and
- Demonstrate compliance of the site with the relevant codes, standards and regulations (i.e. NSW Planning and Assessment Regulation 1979, WHS Regulation, 2011 Ref. [4]).

1.3 Scope of Services

The scope of work is to complete a PHA study for the Warehouse located at 813 Wallgrove Road, Horsley Park, required by the Planning Regulations. The scope does not include any other assessments at the site nor any other DHL facilities.

2.0 Methodology

2.1 Multi-Level Risk Assessment

The Multi-Level Risk Assessment approach (Ref. [4]) published by the NSW Department of Planning and Environment, has been used as the basis for the study to determine the level of risk assessment required. The approach considered the development in context of its location, the quantity and type (i.e. hazardous nature) Dangerous Goods stored and used, and the facility’s technical and safety management control. The Multi-Level Risk Assessment Guidelines are intended to assist industry, consultants and the consent authorities to carry out and evaluate risk assessments at an appropriate level for the facility being studied.

There are three levels of risk assessment set out in Multi-Level Risk Assessment which may be appropriate for a PHA, as detailed in **Table 2-1**.

Table 2-1: Level of Assessment PHA

| Level | Type of Analysis | Appropriate If: |
|-------|------------------------|--|
| 1 | Qualitative | No major off-site consequences and societal risk is negligible |
| 2 | Partially Quantitative | Off-site consequences but with low frequency of occurrence |
| 3 | Quantitative | Where 1 and 2 are exceeded |

The Multi-Level Risk Assessment approach is schematically presented in **Figure 2-1**.

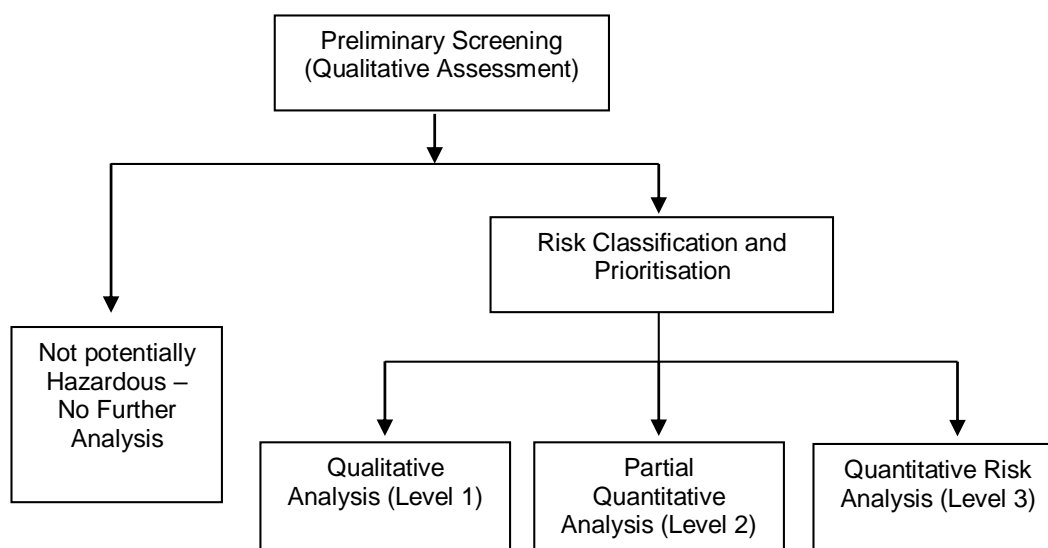

Figure 2-1: The Multi-Level Risk Assessment Approach

Based on the type of DGs to be used and handled at the proposed facility, a **Level 2 Assessment** was selected for the Site. This approach provides a qualitative assessment of those DGs of lesser quantities and hazard, and a quantitative approach for the more hazardous materials to be used on-site. This approach is commensurate with the methodologies recommended in “Applying SEPP 33’s” Multi Level Risk Assessment approach (DPE, 2011).

2.2 Risk Assessment Study Approach

The methodology used for the PHA is as follows;

Hazard Analysis – A detailed hazard identification was conducted for the site facilities and operations. Where an incident was identified to have a potential off-site impact, it was included in the recorded hazard identification word diagram (**Appendix A**). The hazard identification word diagram lists incident type, causes, consequences and safeguards. This was performed using the word diagram format recommended in HIPAP No. 6 (Ref. [3]).

Each postulated hazardous incident was assessed qualitatively in light of proposed safeguards (technical and management controls). Where a potential offsite impact was identified, the incident was carried into the main report for further analysis. Where the qualitative review in the main report determined that the safeguards were adequate to control the hazard, or that the consequence would obviously have no offsite impact, no further analysis was performed. **Section 3.1** of this report provides details of values used to assist in selecting incidents required to be carried forward for further analysis.

Consequence Analysis – For those incidents qualitatively identified in the hazard analysis to have a potential offsite impact, a detailed consequence analysis was conducted. The analysis modelled the various postulated hazardous incidents and determined impact distances from the incident source. The results were compared to the consequence criteria listed in HIPAP No. 4 (Ref. [2]). The criteria selected for screening incidents is discussed in **Section 3.1**.

Where an incident was identified to result in an offsite impact, it was carried forward for frequency analysis. Where an incident was identified to not have an offsite impact, and a simple solution was evident (i.e. move the proposed equipment further away from the boundary), the solution was recommended, and no further analysis was performed.

Frequency Analysis – In the event a simple solution for managing consequence impacts was not evident, each incident identified to have potential offsite impact was subjected to a frequency analysis. The analysis considered the initiating event and probability of failure of the safeguards (both hardware and software). The results of the frequency analysis were then carried forward to the risk assessment and reduction stage for combination with the consequence analysis results.

Risk Assessment and Reduction – Where incidents were identified to impact offsite and where a consequence and frequency analysis was conducted, the consequence and frequency analysis for each incident were combined to determine the risk and then compared to the risk criteria published in HIPAP No. 4 (Ref. [2]). Where the criteria were exceeded, a review of the major risk contributors was performed, and the risks reassessed incorporating the recommended risk reduction measures. Recommendations were then made regarding risk reduction measures.

Reporting – on completion of the study, a draft report was developed for review and comment by DHL. A final report was then developed, incorporating the comments received by DHL for submission to the regulatory authority.

3.0 Site Description

3.1 Site Location

The site is located at 813 Walgrove Road, Horsley Park which is approximately 43 km west of the Sydney Central Business District (CBD). **Figure 3-1** shows the regional location of the site in relation to the Sydney CBD. Provided in **Figure 3-2** is the layout of the site in Horsley Park.

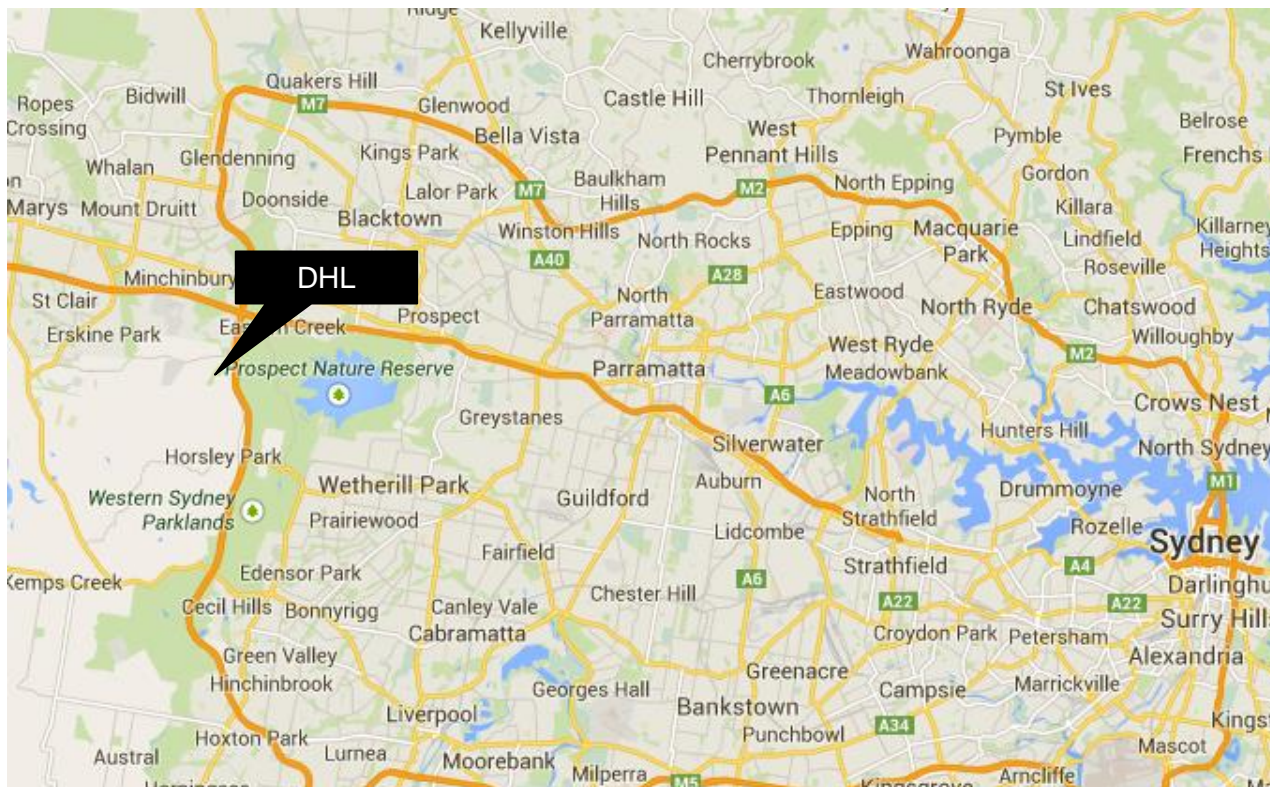

Figure 3-1: Site Location

3.2 Adjacent Land Uses

The land is located in an industrial area surrounded by the following land uses, which are adjacent to the site:

- North – Undeveloped land
- South – Undeveloped land
- East – Undeveloped land
- West – Undeveloped land

3.3 Site Description

The warehouse will store a range of DGs in retail packages and the facility will be designed to comply with AS/NZS 3833:2007 (Ref. [5]). Specifically, the facility will comply with the Retail Distribution Centre (RDC) section of the standard which accounts for the reduced risk posed by packages stored in restricted small volumes.

The warehouse will be protected by a bespoke automatic sprinkler system involving both ceiling mounted and in-rack sprinklers depending on commodities stored. The sprinklers which will

activate upon fire detection which will suppress and control any fire that may occur. The warehouse will be naturally ventilated for occupation purposes which will provide adequate ventilation flow for preventing accumulation of any vapours released from packages in storage as required by AS/NZS 3833:2007 (Ref. [5]).

All DG products will be protected by base building specified Storage Mode Sprinkler System (SMSS) sprinklers and the aerosols will be protected by in-rack sprinklers scheme A sprinkler systems designed according to AS 2118.1:2017 (Ref. [6]). All DG areas will be protected by hose reel coverage in addition to hydrant coverage.

The whole site will be capable of containing at least 90 minutes of potentially contaminated fire water as required by AS/NZS 3833:2007 (Ref. [5]) and the NSW “Best Practice Guidelines for Contaminated Water and Retention Systems” (Ref. [7]). The water will be contained via isolation of the stormwater system which is performed by the actuation of a penstock valve upon fire detection.

The site will be subject to a hazardous area classification per AS/NZS 60079.10.1:2009 (Ref. [8]) and any electrical equipment within the hazardous zone will be compliant per AS/NZS 60079.14:2017 (Ref. [9]) to minimise the potential for ignition of flammable vapours which may be released during storage.

3.4 Quantities of Dangerous Goods Stored and Handled

The dangerous goods stored at the warehouse are for various customers and may fluctuate with customer requirements. The classes and quantities to be approved in the facility are summarised **Table 3-1**. The proposed DG storage locations are shown in **Figure 3-2**.

Table 3-1: Maximum Classes and Quantities of Dangerous Goods Stored

| Class | Description | Packing Group | Quantity (kg) |
|-------|----------------------------|---------------|-------------------|
| 2.1 | Flammable gases (aerosols) | n/a | 100,000 / 25,000* |
| 3 | Flammable liquids | II & III | 200,000 |
| 5.1 | Oxidising agents | II & III | 50,000 |
| 6.1 | Toxic substances | II & III | 50,000 |
| 8 | Corrosive substances | II & III | 100,000 |
| 9 | Miscellaneous DGs | III | 20,000 |

*Note: This refers to the quantity of propellant within the aerosols and not the total package weight. The propellant content within the cannisters is typically around 25% of product weight.

3.5 Aggregate Quantity Ratio

Where more than one class of dangerous goods are stored and handled at the site an AQR exists. This ratio is calculated using **Equation 3-1**:

$$AQR = \frac{q_x}{Q_x} + \frac{q_y}{Q_y} + [...] + \frac{q_n}{Q_n} \quad \text{Equation 3-1}$$

Where:

x,y [...] and n are the dangerous goods present

q_x, q_y, [...] and q_n is the total quantity of dangerous goods x, y, [...] and n present.

Q_x , Q_y , [...] and Q_n is the individual threshold quantity for each dangerous good of x , y , [...] and n

Where the ratio AQR exceeds a value of 1, the site would be considered a Major Hazard Facility (MHF). The threshold quantity for each class is taken from Schedule 15 of the Work Health and Safety (WHS) Regulation 2017 (Ref. [10]). These are summarised in **Table 3-2** noting Class 8, is not subject to MHF legislation.

Table 3-2: Major Hazard Facility Thresholds

| Class | Packing Group | Threshold (tonnes) | Storage (tonnes) |
|-------|---------------|--------------------|------------------|
| 2.1 | n/a | 200 | 25.0 |
| 3 | II & III | 50,000 | 200 |
| 5.1 | II & III | 200 | 50 |
| 6.1 | II & III | 200 | 50 |
| 8 | II & III | Not subject to MHF | 100 |
| 9 | III | Not subject to MHF | 20 |

A review of the thresholds and the commodities and packing groups listed in **Table 3-1** indicates only Class 2.1, 3, 5.1, and 6.1 are assessable against the MHF thresholds. Therefore, substituting the storage masses into **Equation 3-1** the AQR is calculated as follows:

$$AQR = \frac{25.0}{200} + \frac{200}{50000} + \frac{50}{200} + \frac{50}{200} = 0.629$$

The AQR is less than 1; hence, the facility would not be classified as an MHF.

4.0 Hazard Identification

4.1 Introduction

A hazard identification table has been developed and is presented at **Appendix A**. This table has been developed following the recommended approach in Hazardous Industry Planning Advisory Paper No .6, Hazard Analysis Guidelines (Ref. [3]). The Hazard Identification Table provides a summary of the potential hazards, consequences and safeguards at the site. The table has been used to identify the hazards for further assessment in this section of the study. Each hazard is identified in detail and no hazards have been eliminated from assessment by qualitative risk assessment prior to detailed hazard assessment in this section of the study.

In order to determine acceptable impact criteria for incidents that would not be considered for further analysis, due to limited impact offsite, the following approach has been applied:

- **Fire Impacts** - It is noted in Hazardous Industry Planning Advisory Paper (HIPAP) No. 4 (Ref. [2]) that a criterion is provided for the maximum permissible heat radiation at the site boundary (4.7 kW/m^2) above which the risk of injury may occur and therefore the risk must be assessed. Hence, to assist in screening those incidents that do not pose a significant risk, for this study, incidents that result in a heat radiation less than 4.7 kW/m^2 , at the site boundary, are screened from further assessment.

Those incidents exceeding 4.7 kW/m^2 at the site boundary are carried forward for further assessment (i.e. frequency and risk). This is a conservative approach, as HIPAP No. 4 (Ref. [2]) indicates that values of heat radiation of 4.7 kW/m^2 should not exceed 50 chances per million per year at sensitive land uses (e.g. residential). It is noted that the closest residential area is more than several hundred meters from the site, hence, by selecting 4.7 kW/m^2 as the consequence impact criteria (at the adjacent industrial site boundary) the assessment is considered conservative.

- **Explosion** - It is noted in HIPAP No. 4 (Ref. [2]) that a criterion is provided for the maximum permissible explosion over pressure at the site boundary (7 kPa) above which the risk of injury may occur and therefore the risk must be assessed. Hence, to assist in screening those incidents that do not pose a significant risk, for this study, incidents that result in an explosion overpressure less than 7 kPa, at the site boundary, are screened from further assessment. Those incidents exceeding 7 kPa, at the site boundary, are carried forward for further assessment (i.e. frequency and risk). Similarly, to the heat radiation impact discussed above, this is conservative as the 7 kPa value listed in HIPAP No. 4 relates to residential areas, which are over more than several hundred meters from the site.
- **Toxicity** – Toxic substances have been proposed to be stored at the site; hence, toxicity has been assessed.
- **Property Damage and Accident Propagation** - It is noted in HIPAP No. 4 (Ref. [2]) that a criterion is provided for the maximum permissible heat radiation/explosion overpressure at the site boundary ($23 \text{ kW/m}^2/14 \text{ kPa}$) above which the risk of property damage and accident propagation to neighbouring sites must be assessed. Hence, to assist in screening those incidents that do not pose a significant risk to incident propagation, for this study, incidents that result in a heat radiation less than 23 kW/m^2 and explosion over pressure less than 14 kPa, at the site boundary, are screened from further assessment. Those incidents

exceeding 23 kW/m² at the site boundary are carried forward for further assessment with respect to incident propagation (i.e. frequency and risk).

- Societal Risk – HIPAP No. 4 (Ref. [2]) discusses the application of societal risk to populations surrounding the proposed potentially hazardous facility. It is noted that HIPAP No. 4 indicates that where a development proposal involves a significant intensification of population, in the vicinity of such a facility, the change in societal risk needs to be taken into account. In the case of the facility, there is currently no significant intensification of population around the proposed site; however, the adjacent land has been rezoned residential; hence, there will be housing located approximately more than several hundred meters from the site. Therefore, societal risk has been considered in the assessment.

4.2 Properties of Dangerous Goods

The type of DGs and quantities stored and used at the site has been described in **Section 3. Table 4-1** provides a description of the DGs stored and handled at the site, including the Class and the hazardous material properties of the DG Class.

Table 4-1: Properties* of the Dangerous Goods and Materials Stored at the Site

| Class | Hazardous Properties |
|--------------------------|---|
| 2.1 – Flammable Gas | Class 2.1 includes flammable gases which are ignitable when in a mixture of 13 per cent or less by volume with air or have a flammable range with air of at least 12 percentage points regardless of the lower flammable limit. Ignited gas may result in explosion or flash fire. Where gas released under pressure from a hole in a pressurised component is ignited, a jet fire may occur. |
| 3 – Flammable Liquids | Class 3 includes flammable liquids which are liquids, or mixtures of liquids, or liquids containing solids in solution or suspension (for example, paints, varnishes, lacquers, etc.) which give off a flammable vapour at temperatures of not more than 60°C closed-cup test or not more than 65.6°C open-cup test. Vapours released may mix with air and if ignited, at the right concentration, will burn resulting in pool fires at the liquid surface. |
| 5.1 -Oxidising Agents | Class 5.1 materials will not combust but these materials include substances which can in a fire event, liberate oxygen and could accelerate the burning of other combustible or flammable materials. Releases to the environment may cause damage to sensitive receptors within the environment. |
| 6.1 – Toxic Substances | Substances liable either to cause death or serious injury or to harm human health if swallowed or inhaled or by skin contact. |
| 8 – Corrosive Substances | Class 8 substances (corrosive substances) are substances which, by chemical action, could cause damage when in contact with living tissue (i.e. necrosis), or, in case of leakage, may materially damage, or even destroy, other goods which come into contact with the leaked corrosive material. Releases to the environment may cause damage to sensitive receptors within the environment. |

* The Australian Code for the Transport of Dangerous Goods by Road and Rail (Ref. [11]).

4.3 Hazard Identification

Based on the hazard identification table presented in **Appendix A**, the following hazardous scenarios have been developed:

- Flammable liquid or gas release, delayed ignition and flash fire or explosion.
- Flammable material spill, ignition and racking fire.

- LPG release (from aerosol), ignition and racking fire.
- Full warehouse fire and radiant heat.
- Full warehouse fire and toxic smoke emission.
- Dangerous goods liquid spill, release and environmental incident.
- Warehouse fire, sprinkler activation and potentially contaminated water release.

Each identified scenario is discussed in further detail in the following sections.

4.4 Flammable Liquid or Gas Release, Delayed Ignition and Flash Fire or Explosion

As noted in **Section 3.0**, flammable liquids will be held at the site for storage and distribution. There is potential that a flammable liquid spill could occur in the warehouse area due to an accident (packages dropped from forklift, punctured by forklift tines) or deterioration of packaging. If a flammable liquid spill occurred, the liquid may begin to evaporate (depending on the material flashpoint and ambient temperature). Where materials do evaporate, there is a potential for accumulation of vapours, forming a vapour cloud above the spill.

If the spill is not identified, the cloud may continue to accumulate, eventually contacting an ignition source. If the cloud is confined (i.e. pallet racking and stored products) the vapour cloud may explode if ignited, or, if it is unconfined, it may result in a flash fire which would burn back to the flammable liquid spill, resulting in a pool fire.

A similar scenario could occur with the release of Liquefied Petroleum Gas (LPG) from an aerosol; however, the formation of a gas cloud would occur immediately as the LPG would instantly flash to gas following release from the canister. It is noted that the potential for a release of LPG is low as aerosol canisters are pressure tested during manufacture and filling, hence, release would predominately result from damaged product rather than deterioration.

A review of the product list to be stored indicates the products are small retail packages as defined by AS/NZS 3833:2007 (Ref. [5]). Therefore, the release from a single flammable liquid container would result in a release <20 L. For flammable gas canisters, the quantity of flammable gas released would be <1 L in the worst-case release. The associated vapour cloud formed by the release of gas or flammable liquid would be insufficient to result in offsite impacts from ignition.

Packages are inspected for damage upon receipt at the loading dock before they are transported into the warehouse. This minimises the likelihood a damaged package is incorrectly stored. Once stored inside the warehouse, deterioration or damage are unlikely to occur.

To minimise the likelihood a flammable vapour cloud may contact an ignition source, the electrical equipment within the DG store hazardous zone will be installed according to the requirements of AS/NZS 60079.14:2017 (Ref. [9]).

It has been proposed to seek approval to operate the site 24 hours a day 7 days a week however the site will be unlikely to be used for these proposed hours of operation. Therefore, if a spill occurred, it would be identified by personnel working in the warehouse where it could be immediately cleaned up. To ensure appropriate cleaning equipment is available, the following recommendation has been made:

- Multiple spill kits be provided around the DG storage areas to ensure spills can be cleaned up immediately following identification.

Based on the warehouse design (controlled ignition sources, etc.), operation practices and the storage of small packages, the risk of a vapour cloud being generated that is large enough to ignite and impact over the site boundary, by way of a vapour cloud explosion or a flash fire, is considered to be low (if not negligible); hence, this hazard has not been carried forward for further analysis.

4.5 Flammable Material Spill, Ignition and Racking Fire

As noted in **Section 4.4**, it is considered that there is a low potential for a package to leak resulting in a flammable material spill and there are several controls in place to minimise the likelihood of a damaged container entering the warehouse and additional controls to minimise the potential that ignition of a flammable material spill could occur.

If a flammable material spill was to occur (e.g. dropped pallet or package during handling) and it was ignited (e.g. by the forklift), the fire would initially be small due to the majority of packages stored being 20 L or less. While a fire would be limited in size, heat generated may impact adjacent packages which may deteriorate and release their contents contributing additional fuel to the fire. As the fire grows Storage Mode Sprinkler System (SMSS) would activate controlling the fire within the sprinkler array and cooling adjacent packages preventing deterioration and reducing the potential for fire growth.

Based on the limited fire size, the design of the warehouse and the installed fire systems, the risks of this incident impacting over the site boundary are considered to be low. Notwithstanding this, this incident has been carried forward for further analysis to demonstrate that the likely impact of an SMSS controlled fire is within the site boundary.

4.6 LPG Release (from Aerosol), Ignition and Racking Fire

As noted in **Section 4.4**, the potential for release of LPG from an aerosol is considered low due to the quality assurance testing on aerosol canisters during the filling process. The release of LPG would likely result from damage to aerosols during transport and storage rather than from deterioration. Packages are inspected upon delivery and an accident involving aerosols would trigger an additional inspection to verify that damage had not occurred prior to storage within the warehouse.

Notwithstanding this, there is the potential for a release of LPG to occur within the storage racking. Due to the hazardous area rated equipment within the area and protocols, it is considered unlikely for an ignition to occur; however, in the event that an ignition of an LPG release did occur a fire could result.

The fire would consume the packaging with the generated heat impacting the adjacent aerosols. As the LPG within the adjacent aerosols expands the canisters may rupture releasing LPG which would ignite and rocket the canister throughout the aerosol cage potentially spreading the fire.

As the fire grows, the SMSS is expected to activate to suppress the fire and cool adjacent packages to minimise the potential for aerosol rupture and rocketing. Activation of this system would control the fire within the sprinkler array.

A sprinkler-controlled fire within the aerosol racking would be unlikely to impact over the site boundary; notwithstanding this, this incident has been carried forward for consequence analysis.

Notwithstanding the above, the following recommendation has been made:

- Aerosols shall be stored in a dedicated storage area which prevents rocketing cans from escalating the incident (i.e. storage in an aerosol cage, separate storage area, or in palletised aerosol cages).

4.7 Full Warehouse Fire and Radiant Heat

There is potential that if a fire occurred and the fire protection systems failed to activate, a small fire may escalate as radiant heat impacts adjacent packages resulting in deterioration and release of additional fuel. While it is considered unlikely for a fire to occur simultaneously with the sprinkler system failing to operate there is the potential for this scenario to occur. Therefore, this incident has been carried forward for further analysis.

4.8 Full Warehouse Fire and Toxic Smoke Emission

As discussed in **Section 4.7** there is the potential for a full warehouse fire to occur in the event of sprinkler failure. During combustion toxic products of combustion may be generated which will be dispersed in the smoke plume which may impact downwind from the site. Depending on the toxicity of the bi-products, this may result in injury or fatality. Therefore, this incident has been carried forward for further analysis.

4.9 Dangerous Goods Liquid Spill, Release and Environmental Incident

There is potential that a spill of the liquid DGs (Class 3, 5.1, 6.1, and 8) could occur at the site which if not contained could be released into the public water course resulting in a potential environmental incident.

To prevent spills escaping from the site per the requirements of AS/NZS 3833:2007 (Ref. [5]) the following recommendation has been made:

- The site shall be designed to contain any spills or contaminated water from a fire incident within the boundaries of the site.

The site will also be designed to prevent the release of any spills from the site, including potentially contaminated water. Therefore, the potential for a release is considered unlikely as this is expected to be contained within the footprint of the warehouse. Nonetheless, in the event of a catastrophic scenario and spills are released from the footprint of the warehouse, it will be necessary to prevent this from being released into the public water course. Therefore, the following recommendation has been made:

- A storm water isolation point (i.e. penstock isolation valve) shall be incorporated into the design. The penstock shall automatically isolate the storm water system upon detection of a fire (smoke or sprinkler activation) to prevent potentially contaminated liquids from entering the water course.

As noted, the volumes of the packages are small (< 20 L) and the site will be designed with a drain isolation system, allowing the containment of any spills within the premises; hence, in the event of a release the full volume will be contained within the warehouse area. As a spill would be contained within the bund/site drainage there is no potential for an environmental incident to occur; hence, this incident has not been carried forward for further analysis.

4.10 Warehouse Fire, Sprinkler Activation and Potentially Contaminated Water Release

In the event of a fire, the SMSS will activate discharging fire with water to control and suppress the fire. Contact of the fire water with DGs may result in contamination which, if released to the local watercourse, could result in environmental damage. The SMSS system delivers approximately 5 m³/min of water which, if operated for a long period, may result in overflow of site bunding and potential release. The facility has been designed to be able to contain all DG spills and liquid effluent resulting from the management of an incident (i.e. fire) within the premises.

The site will hold 60 minutes of water storage on site as required by FM Global standards; hence, to allow for additional conservatism, following a risk assessment methodology as outlined by the Department of Planning document “*Best Practice Guidelines for Potentially Contaminated Water Retention and Treatment Systems*” (Ref. [7]), an allowance of 90 minutes of potentially contaminated water has been selected noting this includes all sources of application (i.e. onsite storage and towns mains) thus far exceeding the 60 minute on site storage. In a DG fire scenario, the following protection systems are likely to be discharging:

- SMSS at 6 m³/min.
- 3 hydrant hoses at 1.8 m³/min.

The total water discharge would be 7.8 m³/min. Therefore, operation for 90 minutes would result in a total discharge of 702 m³. The following recommendation has been made:

- The warehouse and/or site boundaries shall be capable of containing 702 m³ which may be contained within the warehouse footprint, site stormwater pipework and any recessed docks or other containment areas that may be present as part of the site design.
- The civil engineers designing the site containment shall demonstrate the design is capable of containing at least 702 m³.

As noted in **Section 4.9**, an automatic isolation valve has been recommended to be incorporated into the design to prevent the release of potentially contaminated water. Therefore, the volume within the stormwater system can also be used in calculation total volume contained.

Based on the design and containment for the premises, there is adequate fire water retention to meet the ‘*Best Practice Guidelines for Contaminated Water Retention and Treatment Systems*’ (Ref. [7]), hence, this incident has not been carried forward for further analysis.

5.0 Consequence Analysis

The following incidents were identified to have potential to impact off site:

5.1 Incidents Carried Forward for Consequence Analysis

The following incidents were identified to have potential to impact off site:

- Flammable material spill, ignition and racking fire.
- LPG release (from aerosol), ignition and racking fire.
- Full warehouse fire and radiant heat.
- Full warehouse fire and toxic smoke emission.

Each incident has been assessed in the following sections.

5.2 Flammable Material Spill, Ignition and Racking Fire

There is the potential for a fire to develop involving flammable material stored within the warehouse resulting in a racking fire. As the fire grows the SMSS would activate suppressing and controlling the fire while cooling adjacent packages minimising the potential for lateral spread due to radiant heat. A detailed analysis has been conducted in **Appendix B** and the radiant heat impact distances estimated for this scenario are presented in **Table 5-1** with the contours illustrated in **Figure 5-1**.

Table 5-1: Heat Radiation from a Flammable Liquid Racking Fire

| Heat Radiation (kW/m ²) | Distance (m) | |
|-------------------------------------|--------------|-------------|
| | Base Case | Sensitivity |
| 35 | 4.0 | 7.0 |
| 23 | 4.0 | 9.0 |
| 12.6 | 5.0 | 10.0 |
| 4.7 | 8.0 | 18.0 |

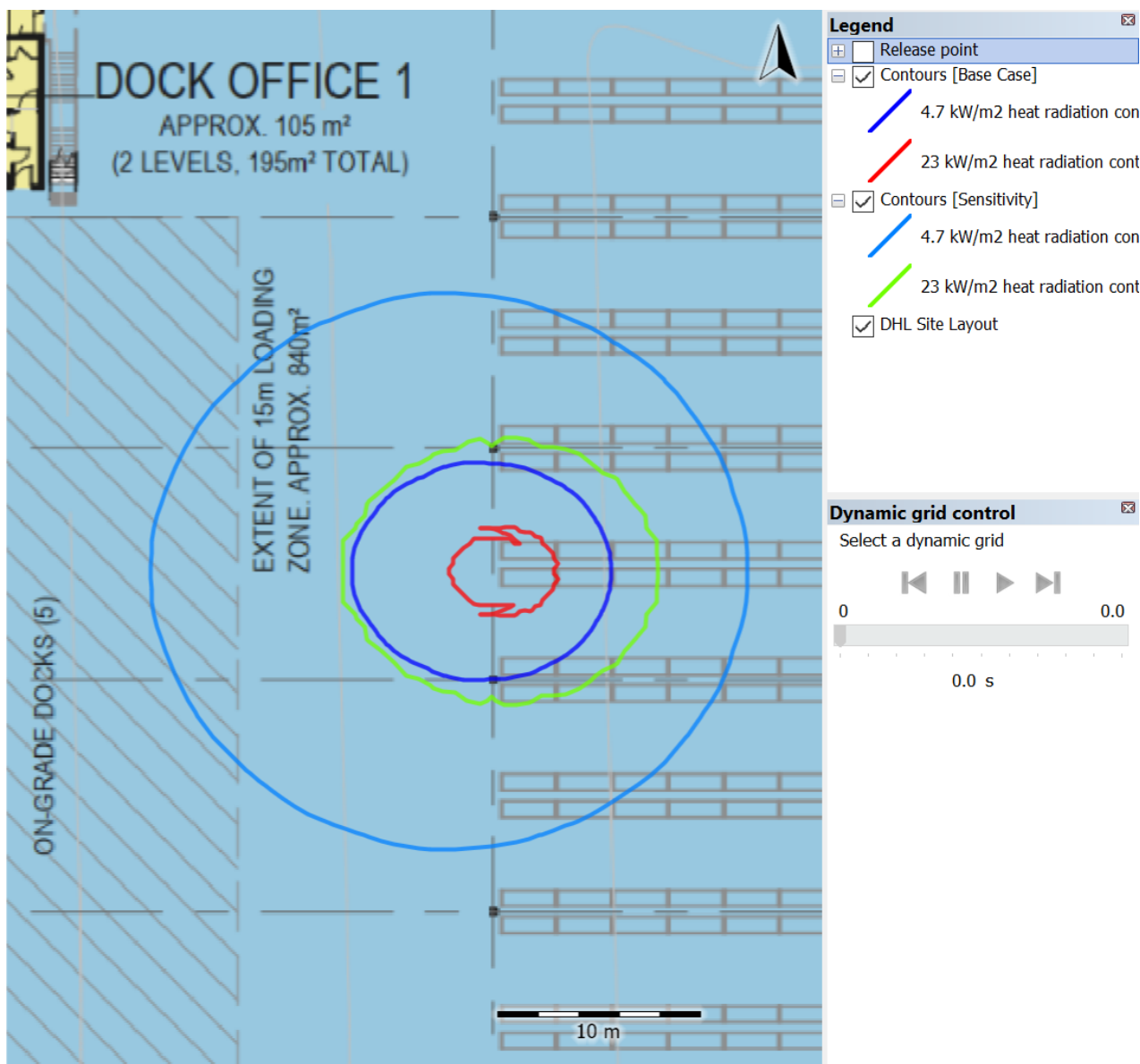

Figure 5-1: Sprinkler Controlled Flammable Material Fire Radiant Heat Contours

A review of the contours illustrated in **Figure 5-1** indicates that neither the 4.7 nor the 23 kW/m² contours impact over the site boundary. As there is no offsite impact, this incident has not been carried forward for further analysis.

5.3 LPG Release (from Aerosol), Ignition and Racking Fire

A damaged aerosol canister could result in the release of LPG which if ignited may result in a fire. As the fire grows the radiant heat may impact adjacent aerosol storage heating the LPG within aerosol cans which may rupture rocketing the canisters around the aerosol store. The heat generated from the fire will activate the SMSS which will suppress and control the fire while cooling adjacent packages minimising the potential for lateral fire spread due to radiant heat. A detailed analysis has been conducted in **Appendix B** and the radiant heat impact distances estimated for this scenario are presented in **Table 5-2** with the contours illustrated in **Figure 5-2**.

Table 5-2: Heat Radiation from an Aerosol Racking Fire

| Heat Radiation (kW/m ²) | Distance (m) | |
|-------------------------------------|--------------|-------------|
| | Base Case | Sensitivity |
| 35 | 6.0 | 13.0 |
| 23 | 7.0 | 16.0 |
| 12.6 | 9.0 | 22.0 |
| 4.7 | 14.0 | 34.0 |

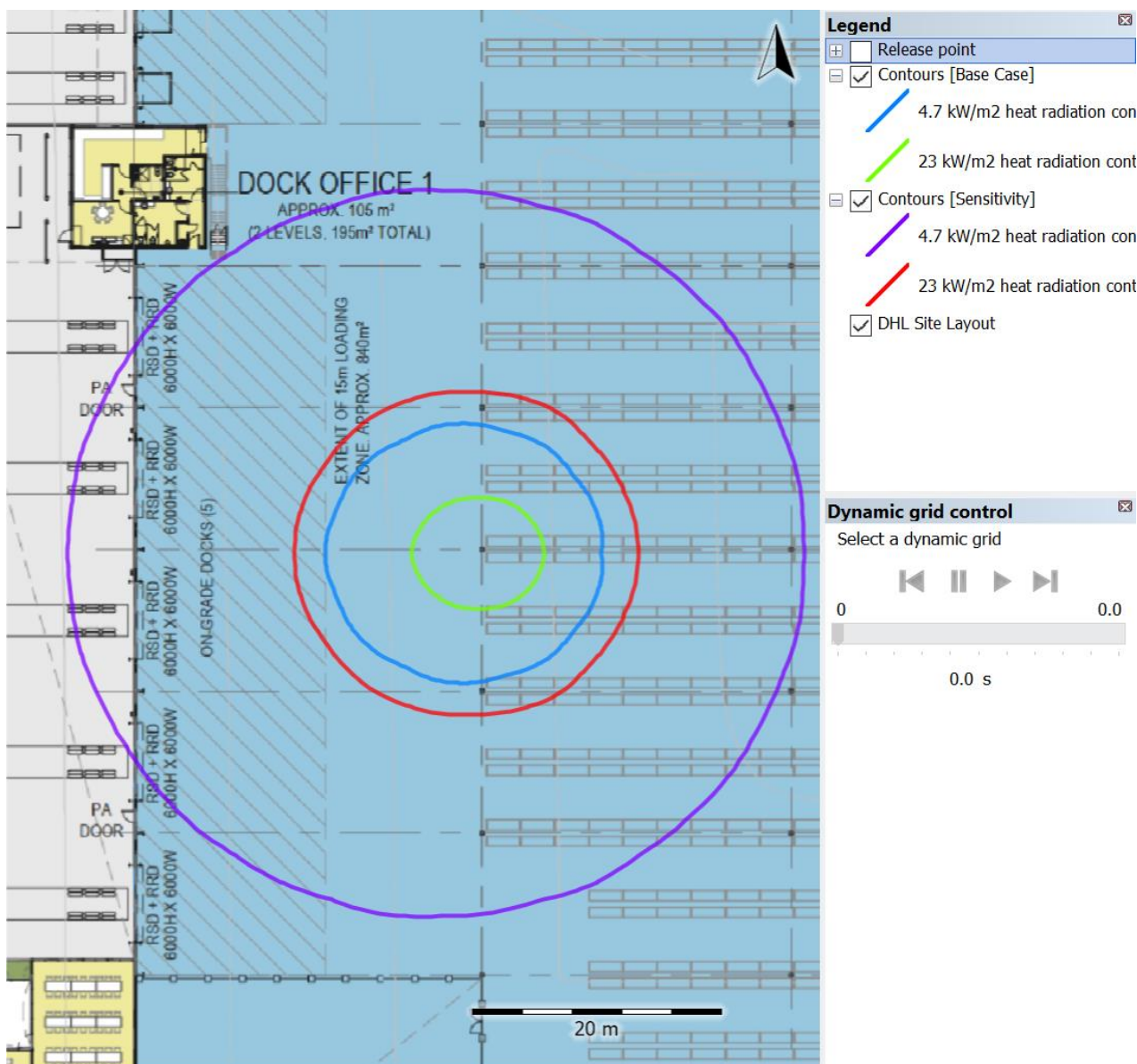

Figure 5-2: Sprinkler Controlled Aerosol Fire Radiant Heat Contours

A review of the contours illustrated in **Figure 5-2** indicates that neither the 4.7 nor the 23 kW/m² contours impact over the site boundary. As there is no offsite impact, this incident has not been carried forward for further analysis.

5.4 Full Warehouse Fire and Radiant Heat

If a fire occurs within the DG store and the sprinkler systems fail to activate, the fire will spread throughout the warehouse and is unlikely to be contained and would likely consume the entire

warehouse. A detailed analysis has been conducted in **Appendix B** and the radiant heat impact distances estimated for this scenario are presented in **Table 5-3**.

Table 5-3: Radiant Heat Impact Distances from a Full Warehouse Fire

| Heat Radiation (kW/m ²) | Distance (m) |
|-------------------------------------|--------------------------|
| 35 | Maximum heat flux is 20* |
| 23 | Maximum heat flux is 20* |
| 12.6 | 43.9 |
| 4.7 | 98.6 |
| 3.0 | 133.7 |

*Based on the research by Mudan & Croche reported in Lees (Ref. [12]) & Cameron/Raman (Ref. [13])

As shown in **Figure 5-3**, the radiant heat impacts at 4.7 kW/m² extend over the site boundary; hence, there is the potential for a fatality at the site boundary to occur. Therefore, this incident has been carried forward for further analysis.

It is noted that due to the fire size there will be considerable smoke emitted which would obscure the flame surface reducing the average surface emissive power (SEP) and subsequently it would not exceed 23 kW/m². In addition, the distance to the closest buildings is 23 m which would allow attenuation of radiant heat from of luminous spots and would not result in sustained radiant heat such that propagation to adjacent facilities would not occur.



Figure 5-3: Full Warehouse Fire Radiant Heat Contours

5.5 Full Warehouse Fire and Toxic Smoke Emission

A detailed analysis has been performed in **Section B7** of **Appendix B** to estimate the impact of toxic bi-products of combustion on the surrounding area. The modelling identified four (4) primary pollutants of concern which may result in downwind impacts; nitrogen dioxide, sulphur dioxide, hydrogen chloride, and soot (carbon) with soot being more for visual disturbance to the surrounding area. The pollutant rates calculated for each pollutant has been shown in **Table 5-4**.

Table 5-4: Full Warehouse Fire Pollutant Release Rates

| Material | Release Rate (kg/s) |
|-------------------|---------------------|
| Nitrogen Dioxide | 52.6 |
| Sulphur Dioxide | 91.1 |
| Hydrogen Chloride | 46.2 |
| Soot (Carbon) | 104.6 |

The model calculates the interaction of the plume with the inversion layer to determine whether a ground level impact would occur from a warehouse fire. The results of the analysis indicates that the heat generated from the fire would be sufficient to pierce the inversion irrespective of the atmospheric stability. As the plume cools it will settle above the inversion layer but would not re-enter below the inversion layer. Therefore, ground level impact is not expected to occur from the warehouse fire.

As the plume would not impact at ground level, the potential for injury or fatality is considered negligible and be unlikely to exceed the acceptable criteria. Notwithstanding the low potential for injury or fatality to occur downwind, this incident has been carried forward for conservatism.

6.0 Frequency Analysis

6.1 Incidents Carried Forward for Frequency Analysis

The following item has been carried forwards for frequency analysis;

- Full warehouse fire and radiant heat.
- Full warehouse fire and toxic smoke emission.

This incident has been assessed in the following section.

6.2 Probability of Failure on Demand

The failure rates for each component identified in the safety systems which protect against the scenarios in the following sections were sourced from 3rd party databases such as; OREDA, Exida, UK Health and Safety Executive (HSE). A summary of the failure rate information has been conducted in **Appendix C**. Also included in this appendix are the calculations for the probability of failure on demand (PFD) for each component which is estimated using **Equation 7-1**.

$$PFD = \frac{1}{2} \lambda_{du} t \quad \text{Equation 7-1}$$

Where:

- λ_{du} = dangerous undetected failures of a component
- t = 1/number of test intervals per annum

6.3 Full Warehouse Fire Frequency and Risk Assessment

The frequency of a full warehouse fire at the site can be estimated from a number of sources (e.g. general warehouse fire frequencies or the summation of individual fire frequencies for each of the initiating fire events). As this is a preliminary hazard analysis, the fire frequency has been selected from general fire frequency data.

A detailed fire frequency analysis has been conducted in **Appendix C**. The results of this analysis indicate that an initiating fire frequency would be in the order of 1×10^{-3} p.a.

It is noted that the site is fitted with multiple automatic sprinkler systems that will initiate on fire detection, controlling the fire and preventing the fire growth to a full warehouse fire. The Centre for Chemical Process Safety (CCPS) provides failure rate data for water fire protection systems including all components (pump, distribution system, nozzles, seals, piping, controls and base plate) of 9.66 per 10^6 hours (Ref. [14]). The hourly failure rate is converted to failures per annum by:

$$\text{Failures per Annum} = \text{Failures per hour} \times 8760 \text{ hours per year}$$

$$\text{Failures per Annum} = 9.66 \times 10^{-6} \times 8760 = 0.085$$

The system will only operate when a fire is detected; hence, the system operates in demand mode. The protection system will be tested monthly totalling 12 tests per annum. The probability of failure on demand (PFD) is estimated using:

$$PFD = \frac{1}{2} \lambda_{du} \left(\frac{1}{t} \right)$$

Where:

λ_{du} = dangerous undetected failures of a component

t = 1/number of test intervals per annum

$$PFD = 0.5 (0.085) (1/12) = 0.00353$$

Hence, the frequency of a full fire within the warehouse is the frequency of an initiating fire x the probability of fail on demand (PFD) of the automatic fire fighting system as shown in **Figure 6-1**.

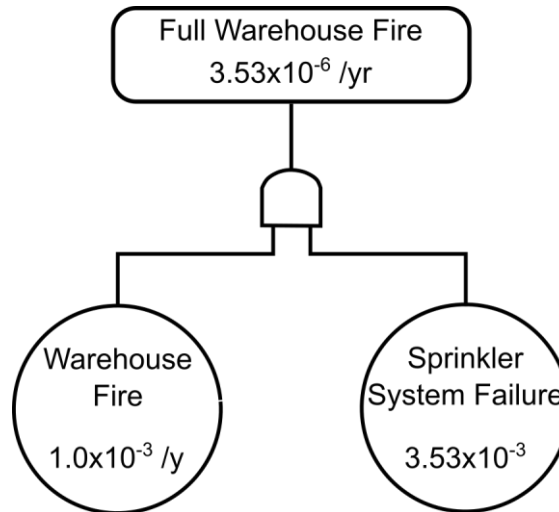

Figure 6-1: Full Warehouse Fire Fault Tree

Conservatively assuming a 100% chance of fatality at the site boundary for a person exposed to radiant heat from a full warehouse fire, the probability of fatality at the site boundary becomes $3.53 \times 10^{-6} \times 1 = 3.53 \times 10^{-6}$ chances of fatality per year or 3.53 chances of a fatality in a million per year (pmpy).

6.4 Full Warehouse Fire and Toxic Smoke Emission Frequency and Risk Assessment

The toxic smoke emission (or toxic bi-products of combustion) is based on the initiating event which is the formation of a full warehouse fire. Therefore, the frequency of the toxic smoke emission is the same as that of the full warehouse which was identified to be 3.53×10^{-6} p.a.

For conservatism, it has been assumed exposure to the smoke will result in an fatality at the site boundary; therefore, the fatality risk of exposure to the toxic smoke becomes $3.53 \times 10^{-6} \times 1 = 3.53$ chances pmpy.

6.5 Total Fatality Risk

Provided in **Table 6-1** is a summary of the incidents which may result in a fatality at the site boundary. The total fatality risk at the site boundary was calculated to be 7.06 chances per million per year (pmpy)

Table 6-1: Total Fatality Risk

| Incident | Fatality Risk |
|---------------------|-----------------------|
| Full warehouse fire | 3.53×10^{-6} |
| Smoke emission | 3.53×10^{-6} |

| Incident | Fatality Risk |
|--------------|-----------------------------|
| Total | 7.06x10⁻⁶ |

6.6 Comparison Against Risk Criteria

The NSW Department of Planning and Environment has issued a guideline on the acceptable risk criteria (Ref. [2]). The acceptable risk criteria published in the guideline relates to injury, fatality and property damage. The values in the guideline present the maximum levels of risk that are permissible at the land use under assessment.

The adjacent land uses are classified as an industrial site as it is restricted access and only industrial operations are permitted to occur in this area. For industrial facilities, the maximum permissible fatality risk is 50 pmpy. The assessed highest fatality risk is 7.06 pmpy at the closest site boundary (northern boundary); hence, the highest risk is within the permissible criteria and therefore all other risk points beyond the boundary would be within the acceptable criteria.

Based on the estimated injury risk, conducted in the analysis above, the risks associated with injury and nuisances at the closest residential area are not considered to be exceeded.

6.7 Cumulative Assessment

A review of the surrounding area indicates there are several warehouses within the vicinity; however, an understanding of the area indicates there are no warehouses storing substantial quantities of DGs within the area; hence, cumulative risks are not considered to be a risk at this stage.

7.0 Conclusion and Recommendations

7.1 Conclusions

A hazard identification table was developed for the warehouse facility to identify potential hazards that may be present at the site as a result of operations or storage of materials. Based on the identified hazards, scenarios were postulated that may result in an incident with a potential for offsite impacts. Postulated scenarios were discussed qualitatively and any scenarios that would not impact offsite were eliminated from further assessment. Scenarios not eliminated were then carried forward for consequence analysis.

Incidents carried forward for consequence analysis were assessed in detail to estimate the impact distances. Impact distances were developed into scenario contours and overlaid onto the site layout diagram to determine if an offsite impact would occur. The consequence analysis showed that one of the scenarios (full warehouse fire) would impact over the site boundary and into the adjacent land use; hence, this incident was carried forward for frequency analysis and risk assessment.

The frequency analysis and risk assessment showed that the full warehouse fire would have a fatality risk of 7.06 chances per million per year (pmpy) at the site boundary, with lesser risk at further distances from the boundary. HIPAP No. 4 (Ref. [2]) publishes acceptable risk criteria at the site boundary of 50 pmpy (for industrial sites). Therefore, the probability of a fatality from a full warehouse fire at the site boundary is within the acceptable risk criteria.

In addition, the only incident which may result in impacts to adjacent structures was a full warehouse fire. Due to the fire size there will be considerable smoke emitted which would obscure the flame surface reducing the average surface emissive power (SEP) and subsequently it would not exceed 23 kW/m². In addition, the distance to the closest buildings is 23 m which would allow attenuation of radiant heat from of luminous spots and would not result in sustained radiant heat such that propagation to adjacent facilities would occur.

Review of the estate proposal indicates this development is the only contributor to the risk profile; hence, cumulative risk is not a consideration at this stage. The cumulative risk at the site is therefore the reported 7.06 chances pmpy which is below the 50 chances pmpy limit. Therefore, the development does not increase the cumulative risk of the estate to an unacceptable level.

Based on the analysis conducted, it is concluded that the risks at the site boundary are not considered to exceed the acceptable risk criteria; hence, the facility would only be classified as potentially hazardous and would be permitted within the current land zoning for the site.

7.2 Recommendations

Notwithstanding the conclusions following the analysis of the facility, the following recommendations have been made:

- The site shall be designed to contain any spills or contaminated water from a fire incident within the boundaries of the site.
- Multiple spill kits be provided around the DG storage areas to ensure spills can be cleaned up immediately following identification.

- The warehouse and/or site boundaries shall be capable of containing 702 m³ which may be contained within the warehouse footprint, site stormwater pipework and any recessed docks or other containment areas that may be present as part of the site design.
- The civil engineers designing the site containment shall demonstrate the design is capable of containing at least 702 m³.
- A storm water isolation point (i.e. penstock isolation valve) shall be incorporated into the design. The penstock shall automatically isolate the storm water system upon detection of a fire (smoke or sprinkler activation) to prevent potentially contaminated liquids from entering the water course.

8.0 References

- [1] NSW Department of Planning and Environment, “Applying SEPP33 – Hazardous and Offensive Developments,” NSW Department of Planning and Environment, Sydney, 2011.
- [2] Department of Planning, “Hazardous Industry Planning Advisory Paper No. 4 - Risk Criteria for Land Use Safety Planning,” Department of Planning, Sydney, 2011.
- [3] Department of Planning, “Hazardous Industry Planning Advisory Paper No. 6 - Guidelines for Hazard Analysis,” Department of Planning, Sydney, 2011.
- [4] Department of Planning, Multi-Level Risk Assessment, Sydney: Department of Planning, 2011.
- [5] Standards Australia, “AS/NZS 3833:2007 - Storage and Handling of Mixed Classes of Dangerous Goods, in Packages and Intermediate Bulk Containers,” Standards Australia, Sydney, 2007.
- [6] Standards Australia, “AS 2118.1:2017 - Automatic Fire Sprinkler Systems General Systems,” Standards Australia, Sydney, 2017.
- [7] NSW Department of Planning, “Best Practice Guidelines for Contaminated Water Retention and Treatment Systems,” NSW Department of Planning, Sydney, 1994.
- [8] Standards Australia, AS/NZS 60079.10.1:2009 - Explosive Atmospheres Part 10.1: Classification of Areas, Explosive Gas Atmospheres, Sydney: Standards Association of Australia, 2009.
- [9] Standards Australia, AS/NZS 60079.14:2017 - Explosive Atmospheres Part 14: Electrical Installations, Design, Selection and Erection, Sydney: Standards Australia, 2017.
- [10] SafeWork NSW, “Work Health and Safety Regulation,” SafeWork NSW, Lisarow, 2017.
- [11] Road Safety Council, The Australian Code for the Transport of Dangerous Goods by Road and Rail Edition 7.7, Canberra: Road Safety Council, 2020.
- [12] F. P. Lees, Loss Prevention in the Process Industries, London: Butterworth-Heinemann, 2005.
- [13] I. Cameron and R. Raman, Process Systems Risk Management, San Diego: Elsevier, 2005.
- [14] Centre for Chemical Process Safety, “Guidelines for Process Equipment Reliability Data with Data Tables,” Centre for Chemical Process Safety, 1989.

Appendix A

Hazard Identification Table

Appendix A

A1. Hazard Identification Table

| ID | Area/Operation | Hazard Cause | Hazard Consequence | Safeguards |
|----|----------------|---|---|---|
| 1 | Warehouse | <ul style="list-style-type: none"> Dropped pallet Damaged packaging (receipt or during storage) Deterioration of packaging | <ul style="list-style-type: none"> Release of Class 2.1, 3, 5.1, 6.1, 8, and 9 to the environment | <ul style="list-style-type: none"> Small retail sized packages (< 20 L) Inspection of packages upon delivery to the site. Trained forklift operators (including spill response training). Storage of DGs within AS/NZS 3833:2007 compliant store (Ref. [5]) |
| 2 | | <ul style="list-style-type: none"> Dropped pallet Damaged packaging (receipt or during storage) Deterioration of packaging | <ul style="list-style-type: none"> Spill of flammable liquids, evolution of flammable vapour cloud ignition and vapour cloud explosion/flash fire Spill of flammable liquids, ignition and pool fire/racking fire | <ul style="list-style-type: none"> Small retail sized packages (< 20 L) Inspection of packages upon delivery to the site Control of ignition sources according to AS/NZS 60079.14:2017 (Ref. [9]) Automatic fire protection system (in-rack and SMSS per AS 2118.1:2017 (Ref. [6])) First attack fire-fighting equipment (e.g. hose reels & extinguishers) Fire detection systems Storage of DGs within AS/NZS 3833:2007 compliant store (Ref. [5]) |
| 3 | | <ul style="list-style-type: none"> Heating of Class 2.1 from a general warehouse fire | <ul style="list-style-type: none"> Rupture, ignition and explosion/rocketing of cylinder within warehouse spreading fire | <ul style="list-style-type: none"> In-rack sprinklers according to AS 2118.1:2017 (Ref. [6]) Automatic fire protection system Aerosols stored within a caged area. |
| 4 | | Sprinkler activation | <ul style="list-style-type: none"> Fire activates SMSS resulting in fire water release and potential contaminated fire water offsite | <ul style="list-style-type: none"> Environmental impact to surrounding areas (e.g. stormwater drainage) |

| ID | Area/Operation | Hazard Cause | Hazard Consequence | Safeguards |
|----|--------------------------|---|---|--|
| | | | | <ul style="list-style-type: none"> Site drainage to comply with the Best Practice Guide for Potentially Contaminated Water Retention and Treatment Systems (Ref. [7]) |
| 5 | Pallet Loading/Unloading | <ul style="list-style-type: none"> Dropped containers from the pallet Impact damage to containers on the pallet (collision with racks or other forklifts) | <ul style="list-style-type: none"> Spill of flammable liquids, evolution of flammable vapour cloud ignition pool, fire under the pallet Full pallet fire as a result of fire growth | <ul style="list-style-type: none"> Trained & licensed forklift drivers First attack fire-fighting equipment (hose reels & extinguishers) SMSS if incident occurs internally No potential for fire growth beyond the single pallet (limited stock externally) |

Appendix B

Consequence Analysis

Appendix B

B1. Incidents Assessed in Detailed Consequence Analysis

The following incidents are assessed for consequence impacts.

- Flammable material spill, ignition and racking fire.
- LPG release (from aerosol), ignition and racking fire.
- Full warehouse fire and radiant heat.
- Full warehouse fire and toxic smoke emission.

Each incident has been assessed in the sections below.

B2. Gexcon - Effects

The modelling was prepared using Effects which is proprietary software owned by Gexcon which has been developed based upon the TNO Coloured books and updated based upon CFD modelling tests and physical verification experiments. The software can model a range of incidents including pool fires, flash fires, explosions, jet fires, toxic dispersions, warehouse smoke plumes, etc.

B3. Radiant Heat Physical Impacts

Appendix Figure B-1 provides noteworthy heat radiation values and the corresponding physical effects of an observer exposed to these values (Ref. [2]).

Appendix Figure B-1: Heat Radiation and Associated Physical Impacts

| Heat Radiation (kW/m ²) | Impact |
|-------------------------------------|---|
| 35 | <ul style="list-style-type: none"> • Cellulosic material will pilot ignite within one minute's exposure • Significant chance of a fatality for people exposed instantaneously |
| 23 | <ul style="list-style-type: none"> • Likely fatality for extended exposure and chance of a fatality for instantaneous exposure • Spontaneous ignition of wood after long exposure • Unprotected steel will reach thermal stress temperatures which can cause failure • Pressure vessel needs to be relieved or failure would occur |
| 12.6 | <ul style="list-style-type: none"> • Significant chance of a fatality for extended exposure. High chance of injury • Causes the temperature of wood to rise to a point where it can be ignited by a naked flame after long exposure • Thin steel with insulation on the side away from the fire may reach a thermal stress level high enough to cause structural failure |
| 4.7 | <ul style="list-style-type: none"> • Will cause pain in 15-20 seconds and injury after 30 seconds exposure (at least second degree burns will occur) |
| 2.1 | <ul style="list-style-type: none"> • Minimum to cause pain after 1 minute |

B4. Flammable Material Spill, Ignition and Racking Fire

In the event that a flammable liquid package is damaged and flammable liquid is released the volatile component will vaporise which may contact an ignition source resulting in a pool fire. As the fire grows it may accelerate the deterioration of other packages resulting in failure and release of additional flammable material and combustion of packaging.

As heat and smoke is generated from the fire, the in-rack sprinklers and the SMSS will activate. Two sprinkler activation scenarios have been assessed:

- A base case scenario whereby the first row of the SMSS activates and controls the spread of a fire.
- A sensitivity scenario whereby the first row of sprinklers fails to activate and the fire is instead controlled by the second row of the SMSS.

The first row of sprinklers has an approximate diameter of 3 m with the second row having an approximate diameter of 9 m. These diameters are used to estimate the flame height and SEP for the fire scenarios. To estimate the flame height and SEP the following information was substituted into the models:

- Equivalent fire diameter: Base – 7 m², Sensitivity – 63.6 m²
- Burning rate – 0.0667 kg/m².s (burning rate for toluene which has selected as a conservative flammable liquid for modelling)

The selection of a flammable liquid burning rate is considered appropriate and conservative as the fire will be composed of burning flammable liquids and packaging. The packaging is a solid material that will yield a lower burning rate than selected as it requires an additional phase change prior to combustion reducing the rate at which the product burns.

Furthermore, the analysis is considered incredibly conservative as it assumes a 100% burning area; however, as the subject areas will encompass aisle spaces, which will have no combustible material stored these locations. Therefore, it is considered the results generated from this analysis would substantially overestimate the radiant heat impacts from the identified scenarios.

The results for flame height and SEP for each scenario are summarised in **Appendix Figure B-2**.

Appendix Figure B-2: Flame Height and SEP for a Flammable Material Sprinkler Controlled Fire

| Output | Base Case | Sensitivity |
|--------------------------|-----------|-------------|
| Flame Height (m) | 7.6 | 16.4 |
| SEP (kW/m ²) | 103.7 | 60.8 |

The inputs summarised in **Appendix Figure B-2** were input into the Effects with the results for each scenario shown in **Appendix Figure B-3**.

Appendix Figure B-3: Heat Radiation from a Flammable Material Sprinkler Controlled Fire

| Heat Radiation (kW/m ²) | Distance (m) | |
|-------------------------------------|--------------|-------------|
| | Base Case | Sensitivity |
| 35 | 4.0 | 7.0 |
| 23 | 4.0 | 9.0 |
| 12.6 | 5.0 | 10.0 |
| 4.7 | 8.0 | 18.0 |

B5. LPG Release (From Aerosol), Ignition and Racking Fire

The release of LPG from a damaged package could result in a fire if the release ignited. The fire would begin to grow expanding LPG within other aerosols which may rupture, ignite and rocket

around the aerosol store. The store is fitted with SMSS and in-rack sprinklers to suppress the fire and cool adjacent packages to minimise the potential for rocketing.

As heat and smoke is generated from the fire, the in-rack sprinklers and the SMSS will activate. Two sprinkler activation scenarios have been assessed:

- A bas case scenario whereby the first row of the SMSS activates and controls the spread of a fire.
- A sensitivity scenario whereby the first row of sprinklers fails to activate and the fire is instead controlled by the second row of the SMSS.

The first row of sprinkler has an approximate diameter of 3 m with the second row having an approximate diameter of 9 m. These diameters are used to estimate the flame height and SEP for the fire scenarios. To estimate the flame height and SEP the following information was substituted into the models:

- Equivalent fire diameter: Base – 7 m², Sensitivity – 63.6 m²
- Burning rate – 0.099 kg/m².s (the burning rate for LPG, Ref. [12]).

The selection of a LPG burning rate is considered appropriate and conservative as a fire involving aerosols will be composed predominantly of packaging (i.e. plastic wrapping and cardboard) which will be punctuated by rupturing of cans and combustion of the released LPG. The packaging is a solid material that will yield a lower burning rate than selected as it requires an additional phase change prior to combustion reducing the rate at which the product burns.

Furthermore, the analysis is considered incredibly conservative as it assumes a 100% burning area; however, as the subject areas will encompass aisle spaces, there will be no combustible material stored in these locations. Therefore, it is considered the results generated from this analysis would substantially overestimate the radiant heat impacts from the identified scenarios.

The results for flame height and SEP for each scenario are summarised in **Appendix Figure B-4**.

Appendix Figure B-4: Flame Height and SEP for Class 2.1 Sprinkler Controlled Scenarios

| Output | Base Case | Sensitivity |
|--------------------------|-----------|-------------|
| Flame Height (m) | 10.8 | 23.2 |
| SEP (kW/m ²) | 103.7 | 60.8 |

The inputs summarised in **Appendix Figure B-4** were input into Effects with the results for each scenario shown in **Appendix Figure B-5**.

Appendix Figure B-5: Heat Radiation from Class 2.1 Sprinkler Controlled Scenarios

| Heat Radiation (kW/m ²) | Distance (m) | |
|-------------------------------------|--------------|-------------|
| | Base Case | Sensitivity |
| 35 | 6.0 | 13.0 |
| 23 | 7.0 | 16.0 |
| 12.6 | 9.0 | 22.0 |
| 4.7 | 14.0 | 34.0 |

B6. Full Warehouse Fire

A full warehouse fire would consume the combustible load stored within the warehouse which covers an approximate area of 18,200 m². A burning rate of 0.054 kg/m².s has been selected which is considered conservative as the majority of product stored within the warehouse is non-DG and this burning rate reflects that of relatively flammable material.

The input parameters entered into the model have been shown in **Appendix Figure B-6**.

| Parameters | |
|--|---------------------------------|
| Inputs | |
| Process Conditions | |
| Chemical name | Diesel Sample (Sample mixtures) |
| Calculation Method | |
| Type of pool fire calculation | Two Zone model Rew & Hulbert |
| Type of pool fire source | Instantaneous |
| Soot definition | Calculate/Default |
| Source Definition | |
| Total mass released (kg) | 1E05 |
| Temperature of the pool (°C) | 20 |
| Process Dimensions | |
| Type of pool shape (pool fire) | Polygon |
| Non burning area within pool (m ²) | 0 |
| Height of the confined pool above ground level (m) | 0 |
| Include shielding at bottomside flame | No |
| Meteo Definition | |
| Wind speed at 10 m height (m/s) | 3 |
| Predefined wind direction | W |
| Environment | |
| Ambient temperature (°C) | 20 |
| Ambient pressure (bar) | 1.0151 |
| Ambient relative humidity (%) | 60 |
| Amount of CO ₂ in atmosphere (-) | 0.0004 |

Appendix Figure B-6: Full Warehouse Fire Input File

The results for flame height and SEP for each scenario are summarised in **Appendix Table B-1**.

Appendix Table B-1: Flame Height and SEP for an Full Warehouse Fire

| Item | Output |
|--------------------------------------|--------|
| Flame Height (m) | 97.7 |
| SEP Sooty Flame (kW/m ²) | 22.2 |

Appendix Table B-2 summarises the radiant heat impact distances calculated for the model.

Appendix Table B-2: Heat Radiation from a Full Warehouse Fire

| Heat Radiation (kW/m ²) | Distance (m) |
|-------------------------------------|--------------|
| 35 | 75 |
| 23 | 85 |
| 12.6 | 116 |
| 4.7 | 185 |

B7. Full Warehouse Fire and Smoke Emission

During the fire, uncombusted toxic products may be present in the smoke plume or toxic bi-products may be generated which will be dispersed in the smoke plume. It is necessary to assess the

associated impacts of the smoke plume downwind of the facility as it may have far reaching impacts on the wider community. When assessing the downwind impacts of the fire plume, the main contributors to the dispersion are:

- The fire size (diameter) and energy released as convective heat
- The atmospheric conditions such as wind speed, relative humidity, atmospheric stability and ambient temperature.

These parameters interact to determine the buoyancy of the smoke plume (vertical rise) which is controlled by the convective energy within the smoke plume in addition to the atmospheric conditions. The atmospheric conditions will vary from stable conditions (generally night time) to unstable conditions (high insolation from solar radiation) which results in substantial vertical mixing which aids in the dispersion. Contributing to this is the impact of wind speed which will limit the vertical rise of a plume but may exacerbate the downwind impact distance.

The atmospheric conditions are classified as Pasquill Guifford’s Stability categories which are summarised in **Appendix Figure B-7** (Ref. [13]).

Appendix Figure B-7: Pasquill’s Stability Categories

| Surface wind speed at 10 m height (m/s) | Insolation | | | Night | |
|---|------------|----------|--------|-------------------------------|-------------|
| | Strong | Moderate | Slight | Thinly overcast or ≥50% cloud | <50% cloud. |
| <2 | A | A-B | B | - | - |
| 2-3 | A-B | B | C | E | F |
| 3-5 | B | B-C | C | D | E |
| 5-6 | C | C-D | D | D | D |
| >6 | C | D | D | D | D |

Generally, the most onerous conditions are F conditions which result in stable air masses and typically have inversion characteristics. Inversion characteristics occur when a warm air mass sits above a cold air mass. Typically, hot air will rise due to lower density than the bulk air; however, in an inversion, a warm air mass sits above the cooler denser air; hence, as the warm air rises through the cold mass it hits a ‘wall’ of warmer air preventing vertical mixing above this point. In a fire scenario, the hot smoke plume will cool as it rises; however, if it encounters an inversion, it will begin to run along this boundary layer preventing vertical mixing and allowing the smoke plume to spread laterally for substantial distances.

A smoke plume is buoyant, and will disperse laterally and vertically as it rises essentially following a Gaussian dispersion as shown in **Appendix Figure B-8** (Ref. [13]).

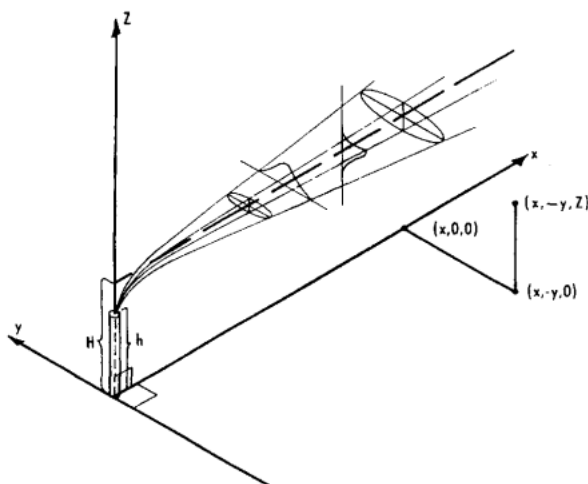

Appendix Figure B-8: Co-ordinate System for Gas Dispersion

RiskEffects has been used to model a smoke plume arising from the warehouse. The model has been developed based on a Gaussian dispersion model accounting for modifications to the plume drag coefficients required to model a plume dispersion from a warehouse fire.

The model requires several inputs which have been summarised in **Appendix Figure B-9** with the associated value input as part of this modelling exercise. D3 conditions have been used to model the plume dispersion.

| Parameters | |
|--|---|
| Inputs | |
| Process Conditions | |
| Phase | Solid |
| Average molecular formula | Translation for "ParameterValues.C390H850O106CI046N117S051P135" is missing! |
| Calculation Method | |
| NO2 conversion fraction (-) | 0.35 |
| Fraction combustion heat radiated (-) | 0.35 |
| Fraction of soot (unburned carbon) (-) | 0.8 |
| Source Definition | |
| Total mass released (kg) | 5.7E06 |
| Surface area of the fire (m2) | 18200 |
| Environment | |
| Ambient temperature (°C) | 20 |

Appendix Figure B-9: Input Data for Plume Gaussian Dispersion

The warehouse was modelled based upon solid product stored within the warehouse and the default settings for solid product within the warehouse was adopted which is based upon typical warehouse configurations within the Netherlands which would be expected to be similar to those expected in Australia. The model then generates the bi-products which may be released from the combustion of the mass which are then individually modelled for each component. Provided in **Appendix Figure B-10** is a summary of the pollutant release rates generated by the model.

Appendix Figure B-10: Pollutant Release Rates

| Material | Release Rate (kg/s) |
|-------------------|---------------------|
| Nitrogen Dioxide | 52.6 |
| Sulphur Dioxide | 91.1 |
| Hydrogen Chloride | 46.2 |

| Material | Release Rate (kg/s) |
|---------------|---------------------|
| Soot (Carbon) | 104.6 |

Each of the pollutants were modelled to determine their plume shape and determine whether the plume would puncture through an inversion layer and what the downwind dispersion would look like as the plume cools and settles in the atmosphere. The plume shapes are shown in **Appendix Figure B-11** to **Appendix Figure B-14**.

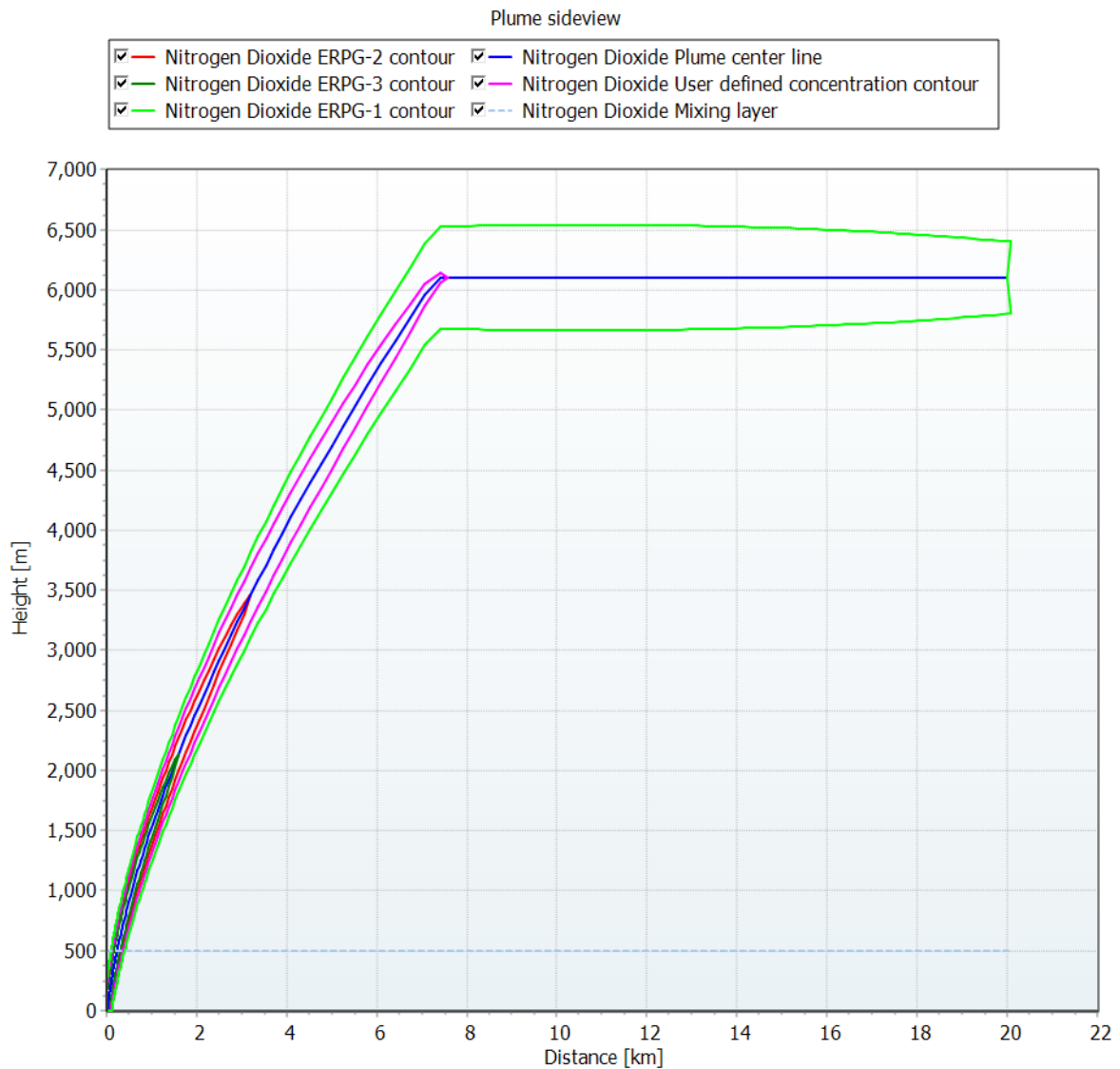

Appendix Figure B-11: Nitrogen Dioxide Downwind Plume Dispersion

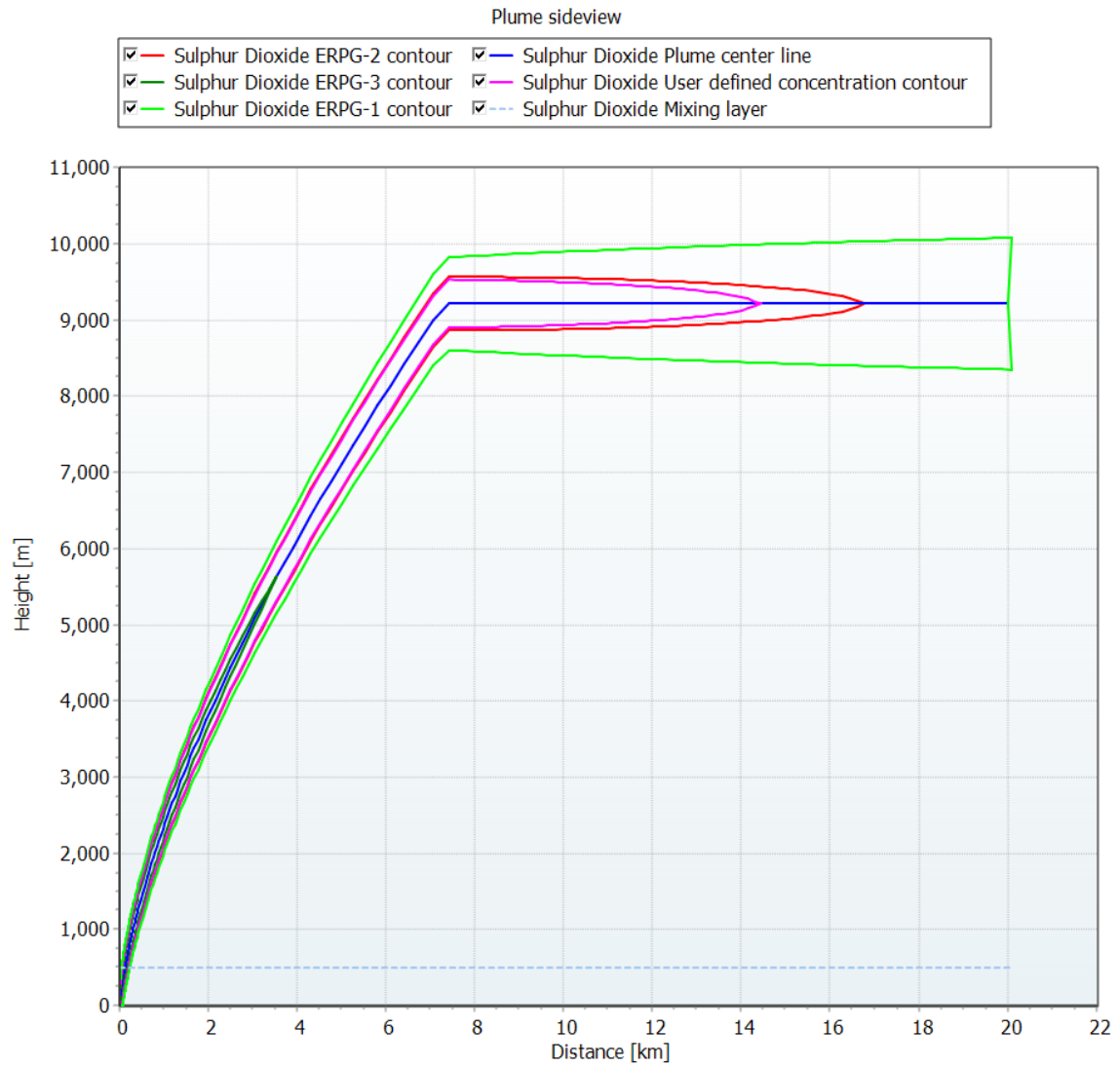

Appendix Figure B-12: Sulphur Dioxide Downwind Plume Dispersion

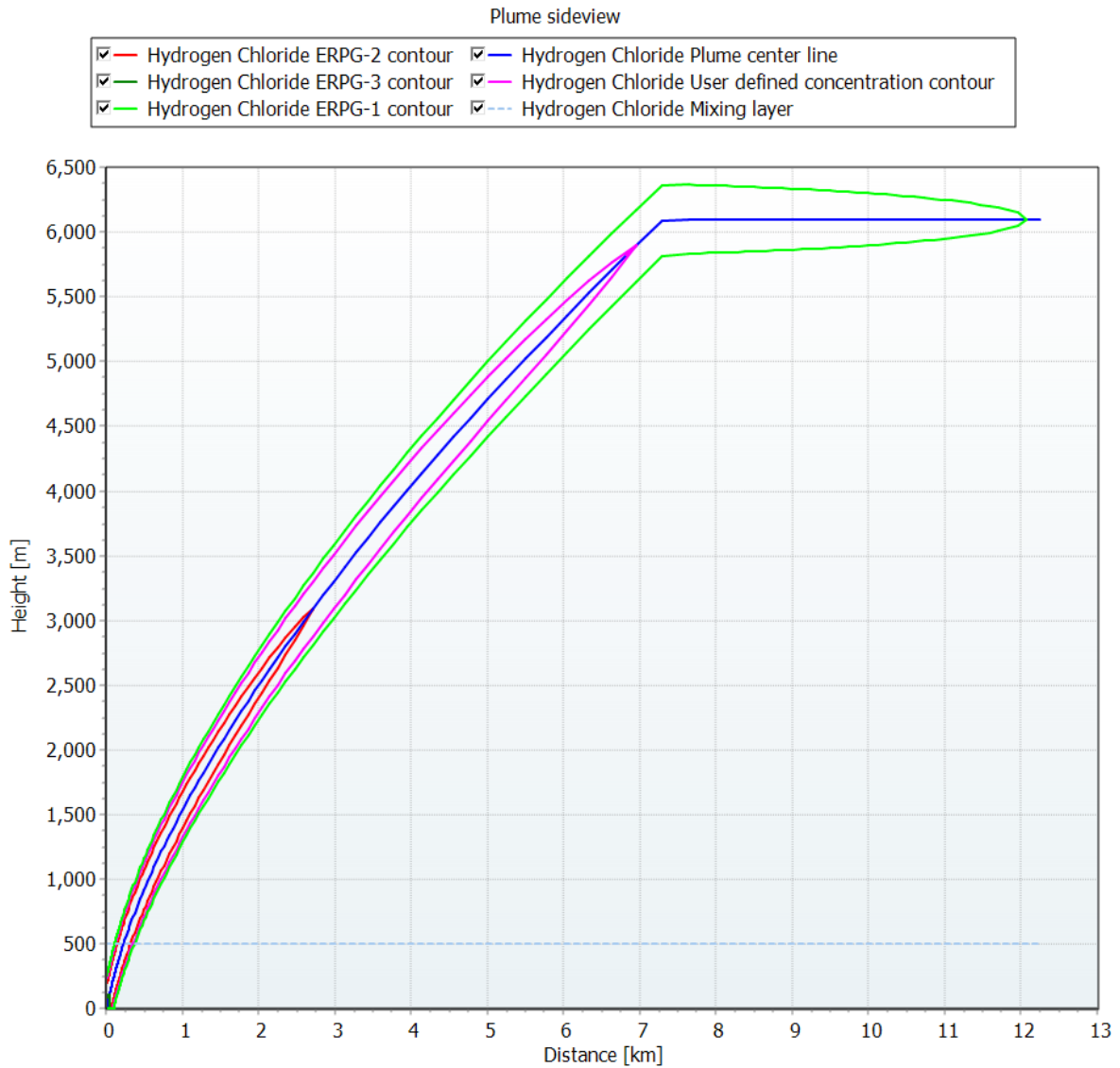

Appendix Figure B-13: Hydrogen Chloride Downwind Plume Dispersion

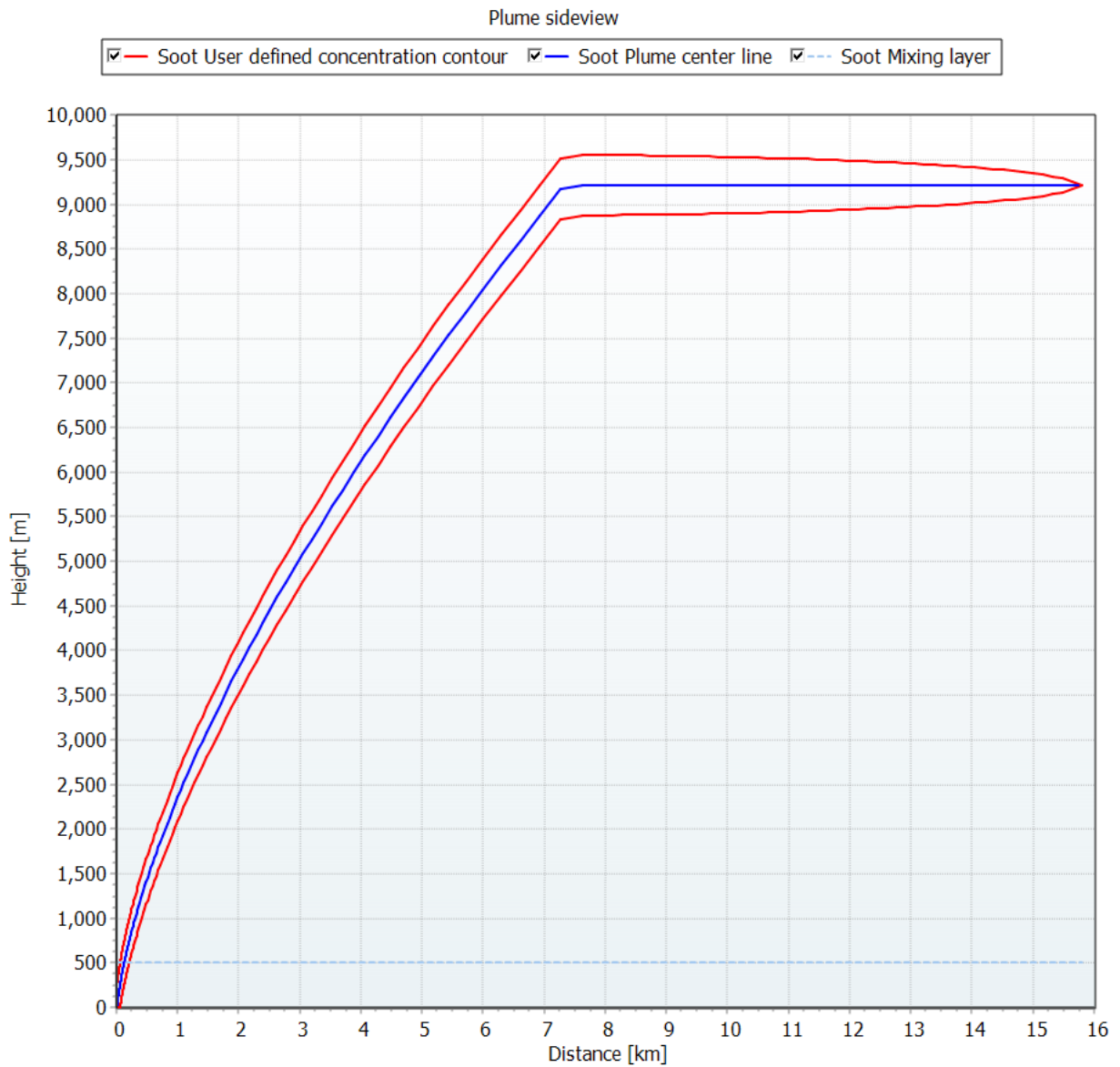

Appendix Figure B-14: Soot (Carbon) Downwind Plume Dispersion

Appendix C

Warehouse Fire Frequency Estimation

Appendix C

C1. Estimation of the Frequency of a Full Warehouse Fire

A review of readily available warehouse fire frequency information was conducted and a number of direct sources were identified. These were:

- Health and Safety Executive (HSE) in the United Kingdom [Hymes & Flynn, UKAEA - SRD/HSE R578, 2002] – this document lists the major warehouse fire frequency to be 2.5×10^{-3} p.a.;
- Baldwin, Accident Analysis and Prevention (Vol.6) – indicates a serious fire frequency in warehouses to be in the order of 1×10^{-3} p.a.;
- Environmental Impact Assessment Report for the Commission of Inquiry into Proposed Manufacturing Plant by WR Grace Australia Ltd., Kurnell, Sydney, October 1987 – indicates a fire frequency of 4.6×10^{-3} per warehouse year; and
- VROM 2005, Guidelines for quantitative risk assessment CPR 18E (Purple Book), Publication Series on Dangerous Substances (PGS 3), The Netherlands. – 4×10^{-4} p.a.

It is noted that the mix of overseas data and local data (albeit some is dated) correlates to indicate a fire frequency in warehouses to be in the order of 1×10^{-3} to 4×10^{-4} . The data presented in the reports reviewed was for general warehouses, where stringent controls for spill and ignition sources (such as flame and explosion proof fittings, bunding, smoking and naked flame controls, isolation of power supplied on warehouse closure, etc.) were not part of the warehouse hazard controls. Hence, for a DG warehouse, containing specific ignition and fire control systems, it would be expected that a major fire would occur with a lesser frequency than that of general warehouses. Notwithstanding this, to ensure a conservative assessment has been provided within the study, the estimated initiating fire frequency for the facility has been estimated as 1×10^{-3} p.a. (i.e. the upper end of the range).

Selected Initiating Fire Frequency = 1×10^{-3} p.a.