

BUILDING A

FLOOR PLAN - GROUND LEVEL

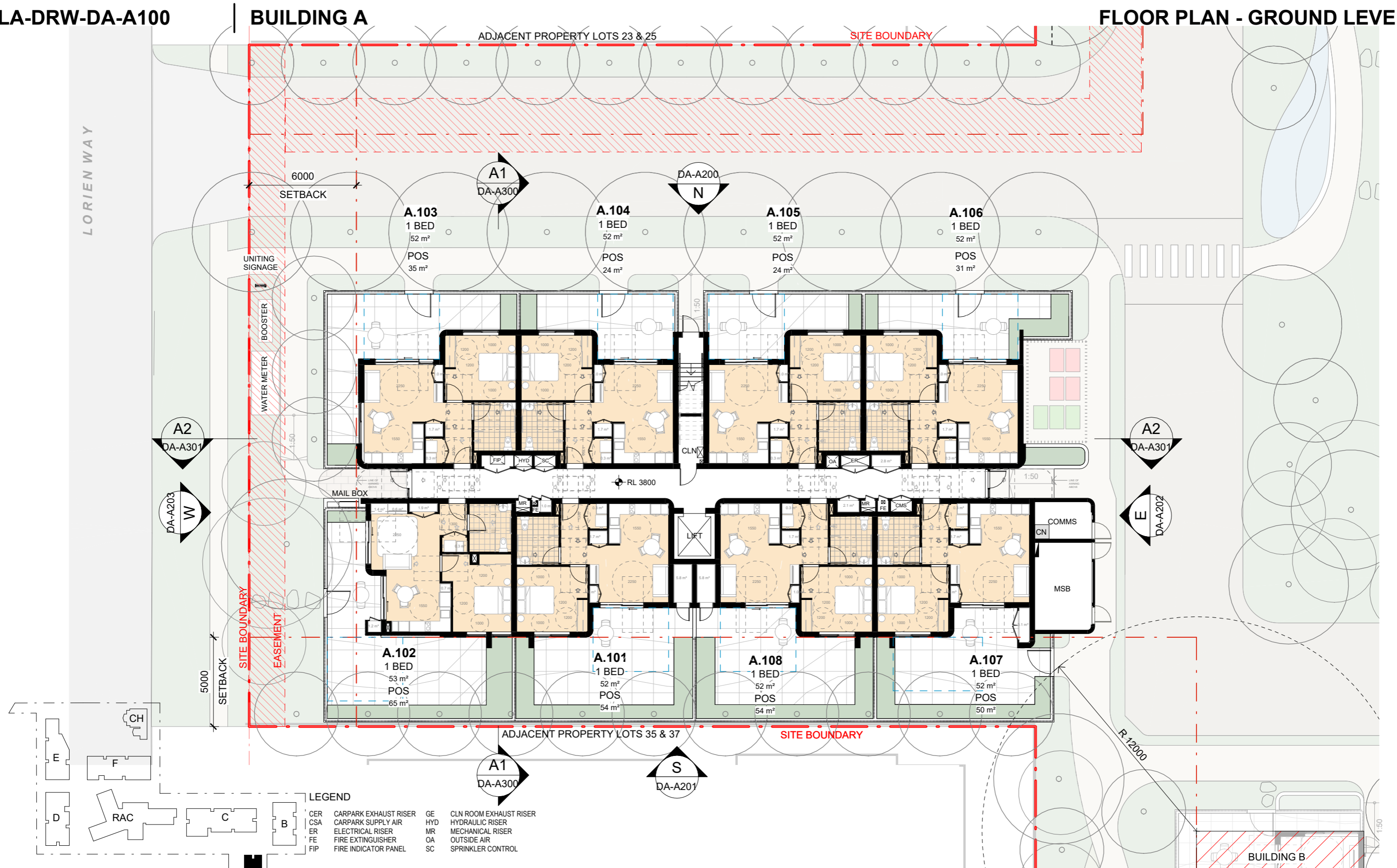

LEGEND

CER	CARPARK EXHAUST RISER	GE	CLN ROOM EXHAUST RISER
CSA	CARPARK SUPPLY AIR	HYD	HYDRAULIC RISER
ER	ELECTRICAL RISER	MR	MECHANICAL RISER
FE	FIRE EXTINGUISHER	OA	OUTSIDE AIR
FIP	FIRE INDICATOR PANEL	SC	SPRINKLER CONTROL

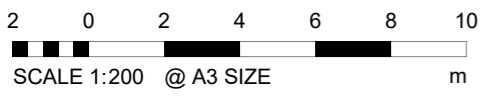

ISSUE A
Date of Issue | 31.01.2024

70303 | UNITING CARE | 24A KINGSCLIFF STREET, KINGSCLIFF, NSW 2487

DATE	DESCRIPTION	BY	CHK	REV
31.01.2024	FOR DA SUBMISSION	VP	CLIENT & CST	A

DISCLAIMER
In accepting and utilising this document the recipient agrees that Plus Architecture Pty. Ltd. ACN 091 690 336, retain all common law, statutory law and other rights including copyright and intellectual property rights. The recipient agrees not to use this document for any purpose other than its intended use; to waive all claims against Plus Architecture resulting from unauthorised changes; or to reuse the document on other projects without the prior written consent of Plus Architecture. Under no circumstances shall transfer of this document be deemed a sale. Plus Architecture makes no warranties of fitness for any purpose. The Builder/Contractor shall verify job dimensions prior to any work commencing. Figured dimensions shall take precedence over scaled work.



NOMINATED ARCHITECTS NSW - Amit Julka 10002; Rido Pin 11286
Level 4, 222 Clarence Street
Sydney NSW 2000
sydney@plusarchitecture.com.au
www.plusarchitecture.com.au
TELEPHONE +61 2 8823 7000
Plus Architecture Sydney Pty Ltd
ACN 618393338

LORIENT WAY

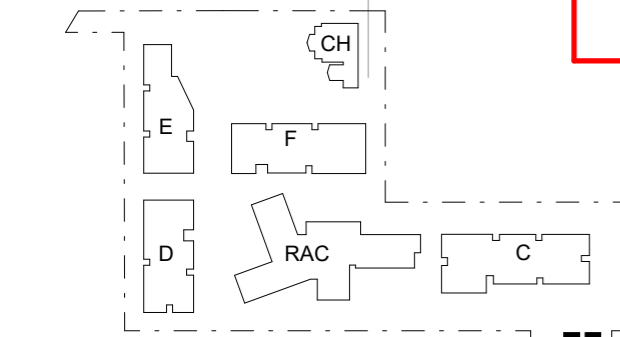
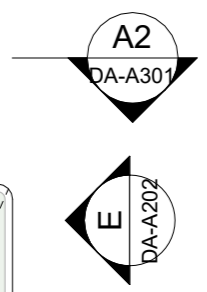
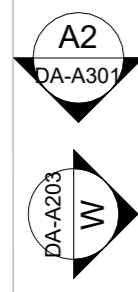
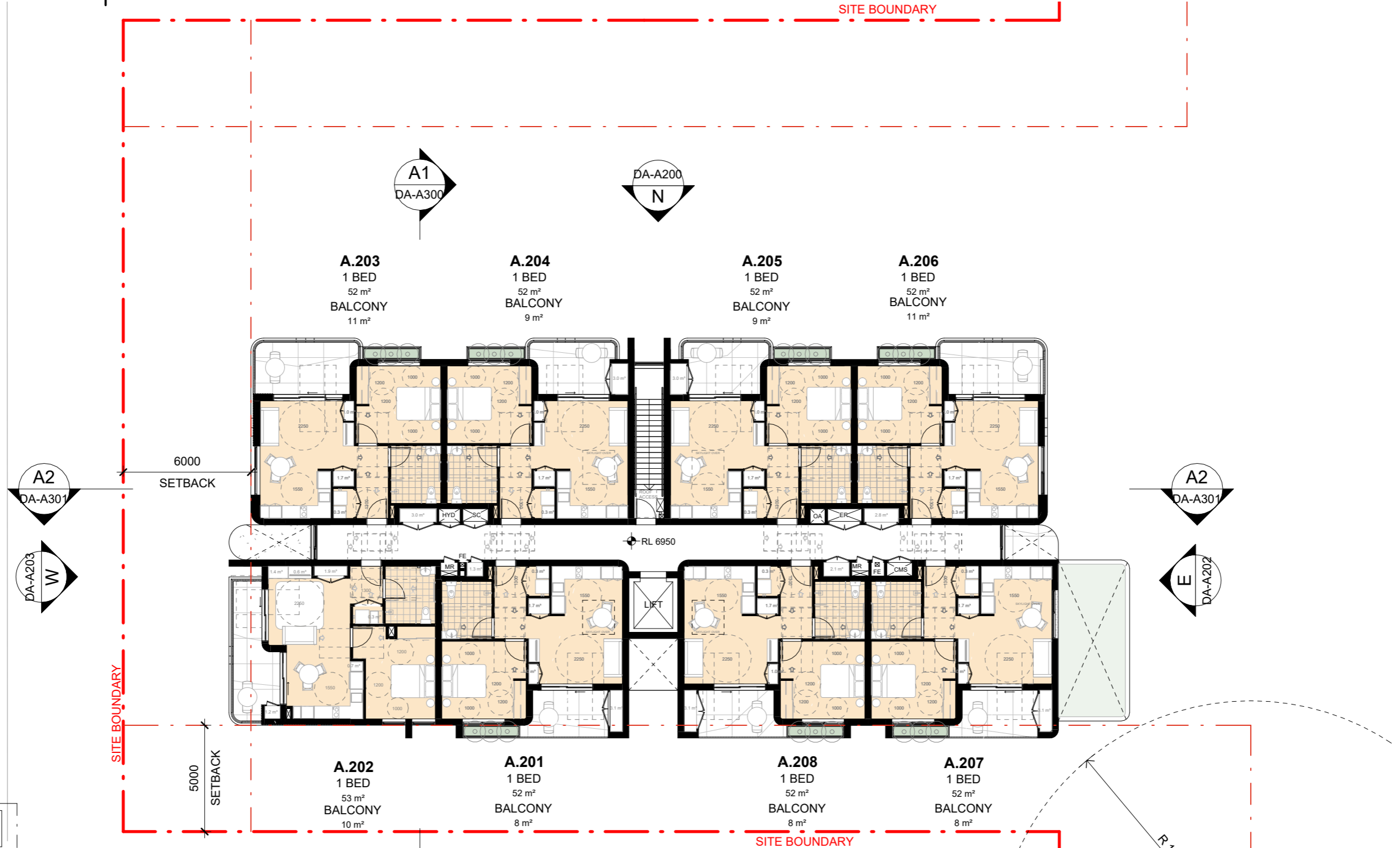

LEGEND

CER	CARPARK EXHAUST RISER	GE	CLN ROOM EXHAUST RISER
CSA	CARPARK SUPPLY AIR	HYD	HYDRAULIC RISER
ER	ELECTRICAL RISER	MR	MECHANICAL RISER
FE	FIRE EXTINGUISHER	OA	OUTSIDE AIR
FIP	FIRE INDICATOR PANEL	SC	SPRINKLER CONTROL

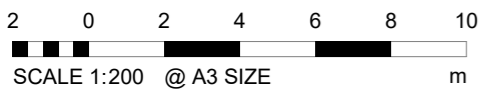

ISSUE A
Date of Issue | 31.01.2024

70303 | UNITING CARE | 24A KINGSCLIFF STREET, KINGSCLIFF, NSW 2487

DATE	DESCRIPTION	BY	CHK	REV
31.01.2024	FOR DA SUBMISSION	VP	CLIENT & CST	A

DISCLAIMER
In accepting and utilising this document the recipient agrees that Plus Architecture Pty. Ltd. ACN 091 690 336, retain all common law, statutory law and other rights including copyright and intellectual property rights. The recipient agrees not to use this document for any purpose other than its intended use; to waive all claims against Plus Architecture resulting from unauthorised changes; or to reuse the document on other projects without the prior written consent of Plus Architecture. Under no circumstances shall transfer of this document be deemed a sale. Plus Architecture makes no warranties of fitness for any purpose. The Builder/Contractor shall verify job dimensions prior to any work commencing. Figured dimensions shall take precedence over scaled work.

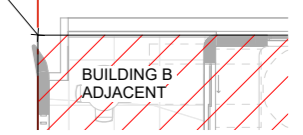

NOMINATED ARCHITECTS NSW - Amit Julka 10002; Rido Pin 11286
Level 4, 222 Clarence Street
Sydney NSW 2000
sydney@plusarchitecture.com.au
www.plusarchitecture.com.au
TELEPHONE +61 2 8823 7000
Plus Architecture Sydney Pty Ltd
ACN 618393338

DRAWING TO BE READ IN CONJUNCTION WITH A0000 LEGEND, RELEVANT SCHEDULES AND PROJECT SPECIFICATION. REFER TO LANDSCAPE ARCHITECT'S DRAWINGS FOR LANDSCAPE AREA DETAILS

LORIENT WAY

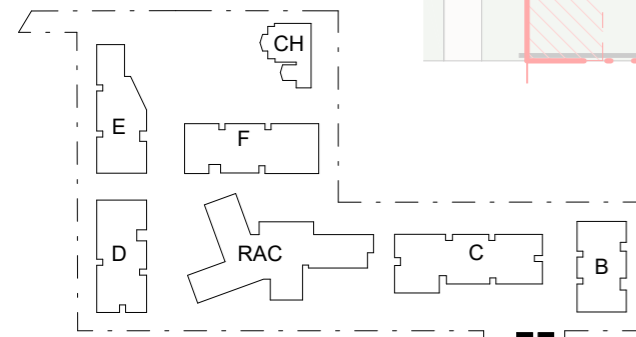
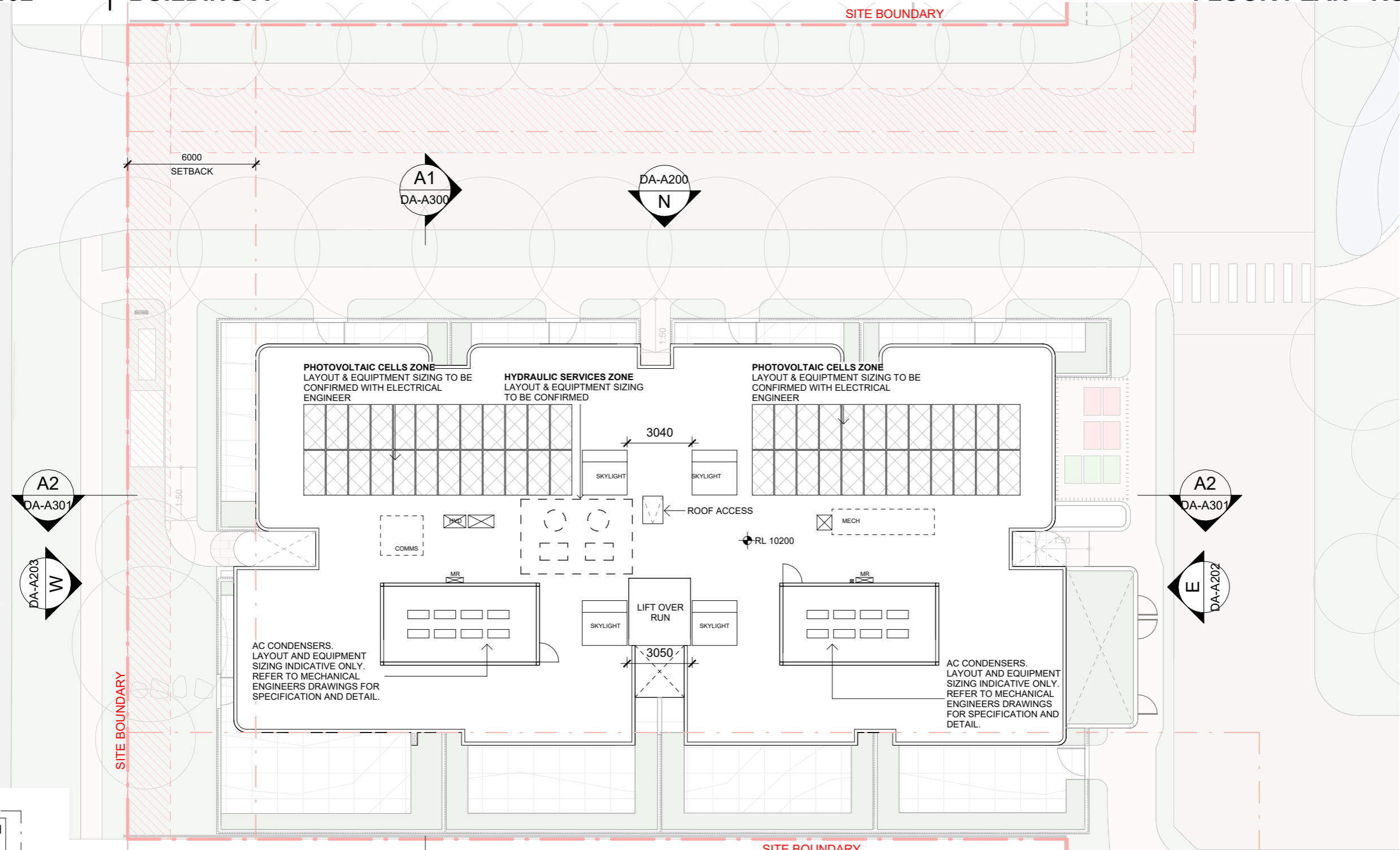

LEGEND

CER	CARPARK EXHAUST RISER	GE	CLN ROOM EXHAUST RISER
CSA	CARPARK SUPPLY AIR	HYD	HYDRAULIC RISER
ER	ELECTRICAL RISER	MR	MECHANICAL RISER
FE	FIRE EXTINGUISHER	OA	OUTSIDE AIR
FIP	FIRE INDICATOR PANEL	SC	SPRINKLER CONTROL

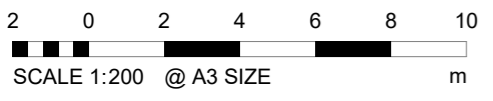

ISSUE A
Date of Issue | 31.01.2024

DATE	DESCRIPTION	BY	CHK	REV
31.01.2024	FOR DA SUBMISSION	VP	CLIENT & CST	A

DISCLAIMER
In accepting and utilising this document the recipient agrees that Plus Architecture Pty. Ltd. ACN 091 690 336, retain all common law, statutory law and other rights including copyright and intellectual property rights. The recipient agrees not to use this document for any purpose other than its intended use; to waive all claims against Plus Architecture resulting from unauthorised changes; or to reuse the document on other projects without the prior written consent of Plus Architecture. Under no circumstances shall transfer of this document be deemed a sale. Plus Architecture makes no warranties of fitness for any purpose. The Builder/Contractor shall verify job dimensions prior to any work commencing. Figured dimensions shall take precedence over scaled work.



NOMINATED ARCHITECTS NSW - Amit Julka 10002; Rido Pin 11286
Level 4, 222 Clarence Street
Sydney NSW 2000
sydney@plusarchitecture.com.au
www.plusarchitecture.com.au
TELEPHONE +61 2 8823 7000
Plus Architecture Sydney Pty Ltd
ACN 618393338

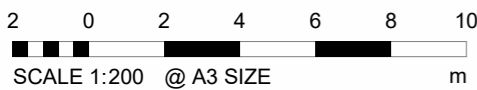

ISSUE A
Date of Issue | 16.02.2024

70303 | UNITING CARE | 24A KINGSCLIFF STREET, KINGSCLIFF, NSW 2487

DATE	DESCRIPTION	BY	CHK	REV
16.02.2024	FOR DA SUBMISSION	VP	CLIENT & CST	A

DISCLAIMER
In accepting and utilising this document the recipient agrees that Plus Architecture Pty. Ltd. ACN 091 690 336, retain all common law, statutory law and other rights including copyright and intellectual property rights. The recipient agrees not to use this document for any purpose other than its intended use; to waive all claims against Plus Architecture resulting from unauthorised changes; or to reuse the document on other projects without the prior written consent of Plus Architecture. Under no circumstances shall transfer of this document be deemed a sale. Plus Architecture makes no warranties of fitness for any purpose. The Builder/Contractor shall verify job dimensions prior to any work commencing. Figured dimensions shall take precedence over scaled work.



EXTERNAL FINISHES LEGEND

- BR1 BRICK TYPE 1
- BR2 BRICK TYPE 2
- BR3 BRICK TYPE 3
- BR4 BRICK TYPE 4
- GL1 GLAZING
- GL2 FRITTED GLAZING
- M1 METAL FINISH - CHARCOAL
- M2 METAL FINISH - BRONZE
- M3 METAL CLADDING - CHARCOAL
- M4 METAL CLADDING - GREY
- M5 METAL CLADDING - BRONZE
- P1 PAINT FINISH - DARK CHARCOAL
- P2 PAINT FINISH - GREY
- P3 PAINT FINISH - OFF WHITE
- P4 PAINT FINISH - TO MATCH M2
- P5 PAINT FINISH - OFF WHITE
- ST1 VERTICAL SCORING
- STONE - NATURAL FINISH

NOMINATED ARCHITECTS NSW - Amit Julka 10002; Rido Pin 11286
 Level 4, 222 Clarence Street TELEPHONE +61 2 8823 7000
 Sydney NSW 2000 Plus Architecture Sydney Pty Ltd
 sydney@plusarchitecture.com.au www.plusarchitecture.com.au ACN 618393338

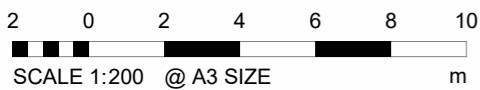
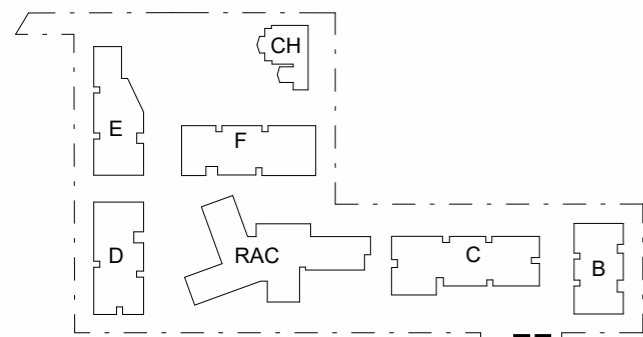
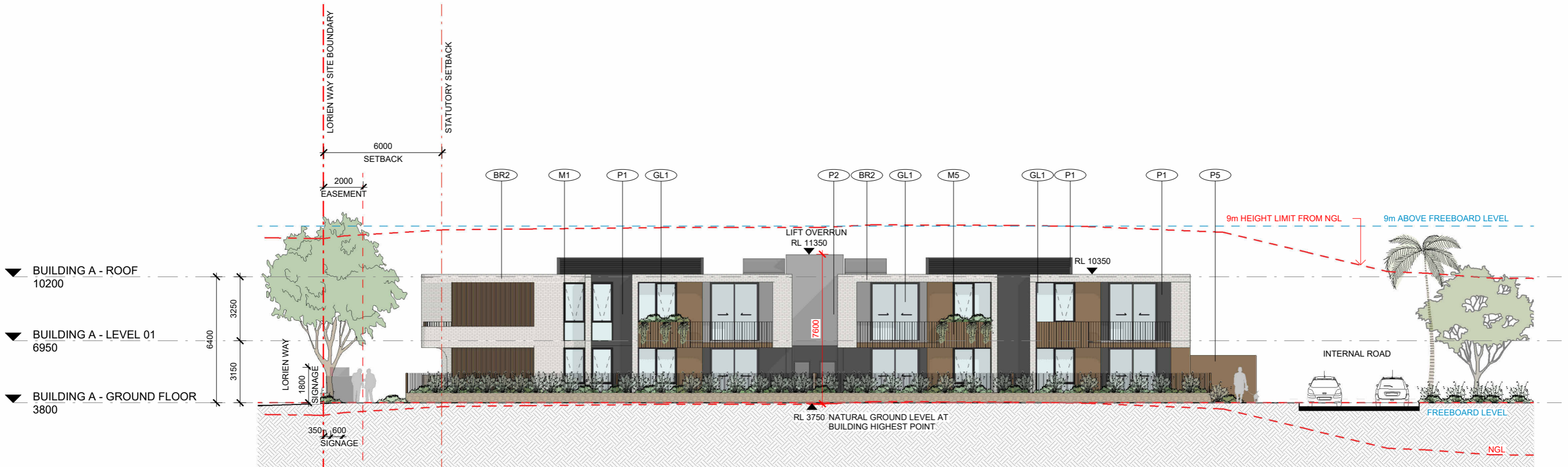

ISSUE A
Date of Issue | 16.02.2024

70303 | UNITING CARE | 24A KINGSCLIFF STREET, KINGSCLIFF, NSW 2487

DATE	DESCRIPTION	BY	CHK	REV
16.02.2024	FOR DA SUBMISSION	VP	CLIENT & CST	A

DISCLAIMER
In accepting and utilising this document the recipient agrees that Plus Architecture Pty. Ltd. ACN 091 690 336, retain all common law, statutory law and other rights including copyright and intellectual property rights. The recipient agrees not to use this document for any purpose other than its intended use; to waive all claims against Plus Architecture resulting from unauthorised changes; or to reuse the document on other projects without the prior written consent of Plus Architecture. Under no circumstances shall transfer of this document be deemed a sale. Plus Architecture makes no warranties of fitness for any purpose. The Builder/Contractor shall verify job dimensions prior to any work commencing. Figured dimensions shall take precedence over scaled work.



EXTERNAL FINISHES LEGEND

- BR1 BRICK TYPE 1
- BR2 BRICK TYPE 2
- BR3 BRICK TYPE 3
- BR4 BRICK TYPE 4
- GL1 GLAZING
- GL2 FRITTED GLAZING
- M1 METAL FINISH - CHARCOAL
- M2 METAL FINISH - BRONZE
- M3 METAL CLADDING - CHARCOAL
- M4 METAL CLADDING - GREY
- M5 METAL CLADDING - BRONZE
- P1 PAINT FINISH - DARK CHARCOAL
- P2 PAINT FINISH - GREY
- P3 PAINT FINISH - OFF WHITE
- P4 PAINT FINISH - TO MATCH M2
- P5 PAINT FINISH - OFF WHITE
- ST1 STONE - NATURAL FINISH

NOMINATED ARCHITECTS NSW - Amit Julka 10002; Rido Pin 11286
 Level 4, 222 Clarence Street TELEPHONE +61 2 8823 7000
 Sydney NSW 2000
 sydney@plusarchitecture.com.au Plus Architecture Sydney Pty Ltd
 www.plusarchitecture.com.au ACN 618393338

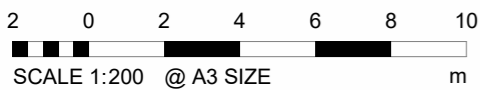
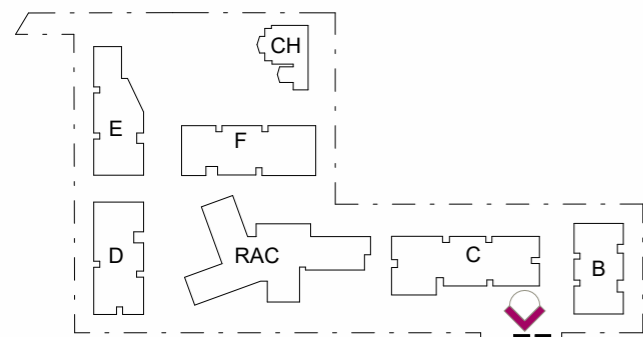

ISSUE A
Date of Issue | 16.02.2024

70303 | UNITING CARE | 24A KINGSCLIFF STREET, KINGSCLIFF, NSW 2487

DATE	DESCRIPTION	BY	CHK	REV
16.02.2024	FOR DA SUBMISSION	VP	CLIENT & CST	A

DISCLAIMER
In accepting and utilising this document the recipient agrees that Plus Architecture Pty. Ltd. ACN 091 690 336, retain all common law, statutory law and other rights including copyright and intellectual property rights. The recipient agrees not to use this document for any purpose other than its intended use; to waive all claims against Plus Architecture resulting from unauthorised changes; or to reuse the document on other projects without the prior written consent of Plus Architecture. Under no circumstances shall transfer of this document be deemed a sale. Plus Architecture makes no warranties of fitness for any purpose. The Builder/Contractor shall verify job dimensions prior to any work commencing. Figured dimensions shall take precedence over scaled work.



EXTERNAL FINISHES LEGEND

- BR1 BRICK TYPE 1
- BR2 BRICK TYPE 2
- BR3 BRICK TYPE 3
- BR4 BRICK TYPE 4
- GL1 GLAZING
- GL2 FRITTED GLAZING
- M1 METAL FINISH - CHARCOAL
- M2 METAL FINISH - BRONZE
- M3 METAL CLADDING - CHARCOAL
- M4 METAL CLADDING - GREY
- M5 METAL CLADDING - BRONZE
- P1 PAINT FINISH - DARK CHARCOAL
- P2 PAINT FINISH - GREY
- P3 PAINT FINISH - OFF WHITE
- P4 PAINT FINISH - TO MATCH M2
- P5 PAINT FINISH - OFF WHITE
- ST1 STONE - NATURAL FINISH

NOMINATED ARCHITECTS NSW - Amit Julka 10002; Rido Pin 11286
Level 4, 222 Clarence Street TELEPHONE +61 2 8823 7000
Sydney NSW 2000
sydney@plusarchitecture.com.au Plus Architecture Sydney Pty Ltd
www.plusarchitecture.com.au ACN 618393338

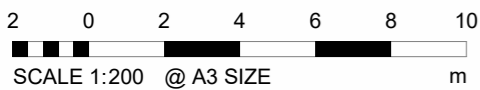
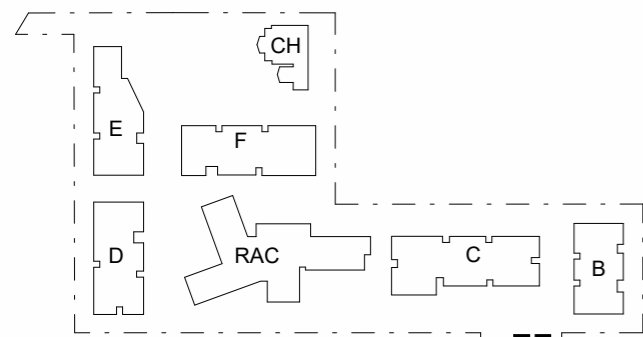

ISSUE A
Date of Issue | 16.02.2024

70303 | UNITING CARE | 24A KINGSCLIFF STREET, KINGSCLIFF, NSW 2487

DATE	DESCRIPTION	BY	CHK	REV
16.02.2024	FOR DA SUBMISSION	VP	CLIENT & CST	A

DISCLAIMER
In accepting and utilising this document the recipient agrees that Plus Architecture Pty. Ltd. ACN 091 690 336, retain all common law, statutory law and other rights including copyright and intellectual property rights. The recipient agrees not to use this document for any purpose other than its intended use; to waive all claims against Plus Architecture resulting from unauthorised changes; or to reuse the document on other projects without the prior written consent of Plus Architecture. Under no circumstances shall transfer of this document be deemed a sale. Plus Architecture makes no warranties of fitness for any purpose. The Builder/Contractor shall verify job dimensions prior to any work commencing. Figured dimensions shall take precedence over scaled work.



EXTERNAL FINISHES LEGEND

- BR1 BRICK TYPE 1
- BR2 BRICK TYPE 2
- BR3 BRICK TYPE 3
- BR4 BRICK TYPE 4
- GL1 GLAZING
- GL2 FRITTED GLAZING
- M1 METAL FINISH - CHARCOAL
- M2 METAL FINISH - BRONZE
- M3 METAL CLADDING - CHARCOAL
- M4 METAL CLADDING - GREY
- M5 METAL CLADDING - BRONZE
- P1 PAINT FINISH - DARK CHARCOAL
- P2 PAINT FINISH - GREY
- P3 PAINT FINISH - OFF WHITE
- P4 PAINT FINISH - TO MATCH M2
- P5 PAINT FINISH - OFF WHITE
- ST1 STONE - NATURAL FINISH

NOMINATED ARCHITECTS NSW - Amit Julka 10002; Rido Pin 11286
 Level 4, 222 Clarence Street TELEPHONE +61 2 8823 7000
 Sydney NSW 2000
 sydney@plusarchitecture.com.au Plus Architecture Sydney Pty Ltd
 www.plusarchitecture.com.au ACN 618393338

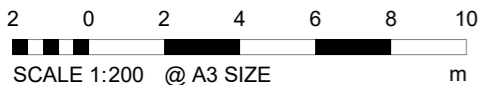
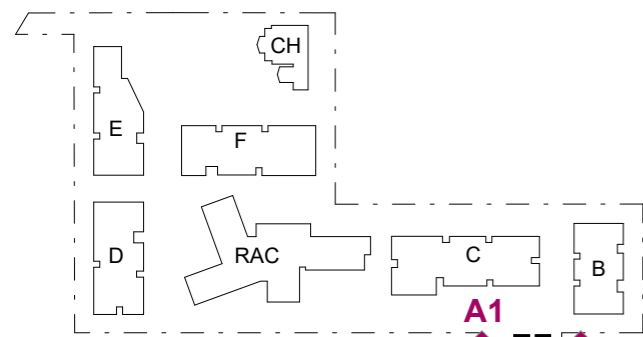
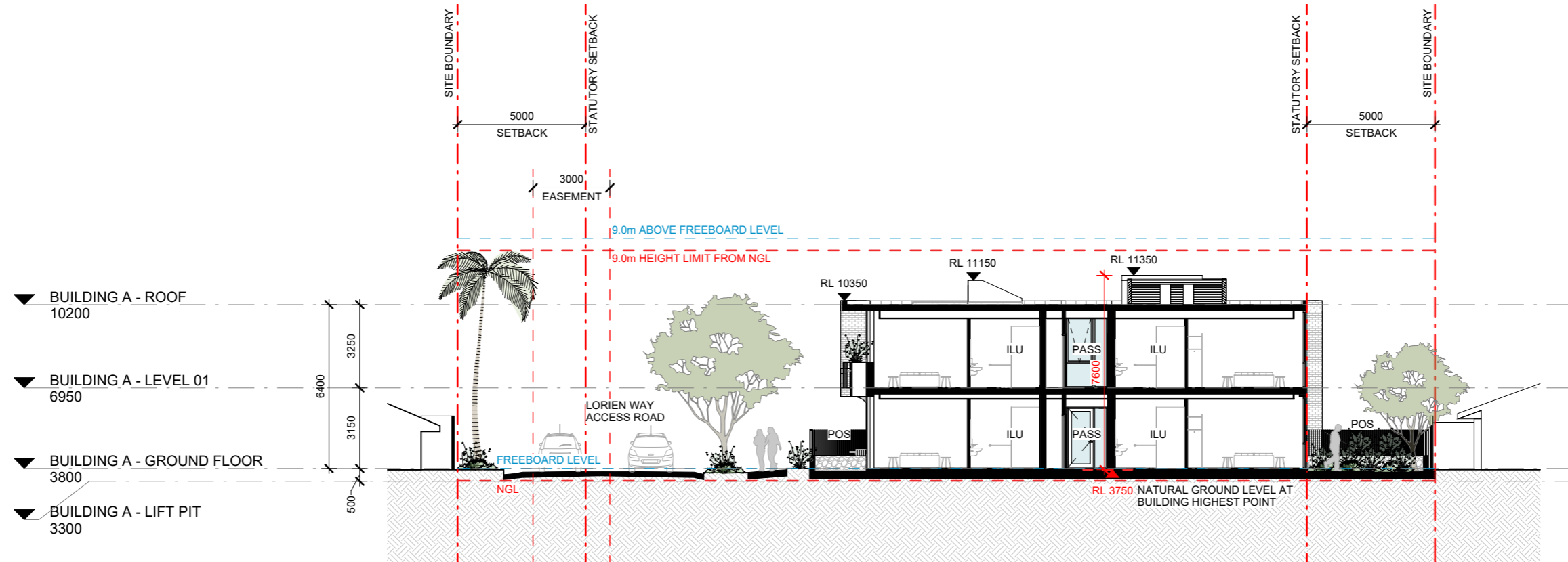

ISSUE A
Date of Issue | 16.02.2024

70303 | UNITING CARE | 24A KINGSCLIFF STREET, KINGSCLIFF, NSW 2487

DATE	DESCRIPTION	BY	CHK	REV
16.02.2024	FOR DA SUBMISSION	VP	CLIENT & CST	A

DISCLAIMER
In accepting and utilising this document the recipient agrees that Plus Architecture Pty. Ltd. ACN 091 690 336, retain all common law, statutory law and other rights including copyright and intellectual property rights. The recipient agrees not to use this document for any purpose other than its intended use; to waive all claims against Plus Architecture resulting from unauthorised changes; or to reuse the document on other projects without the prior written consent of Plus Architecture. Under no circumstances shall transfer of this document be deemed a sale. Plus Architecture makes no warranties of fitness for any purpose. The Builder/Contractor shall verify job dimensions prior to any work commencing. Figured dimensions shall take precedence over scaled work.



NOMINATED ARCHITECTS NSW - Amit Julka 10002; Rido Pin 11286
Level 4, 222 Clarence Street TELEPHONE +61 2 8823 7000
Sydney NSW 2000
sydney@plusarchitecture.com.au Plus Architecture Sydney Pty Ltd
www.plusarchitecture.com.au ACN 618393338

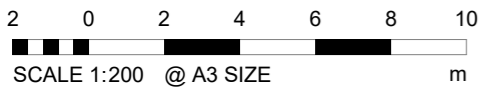
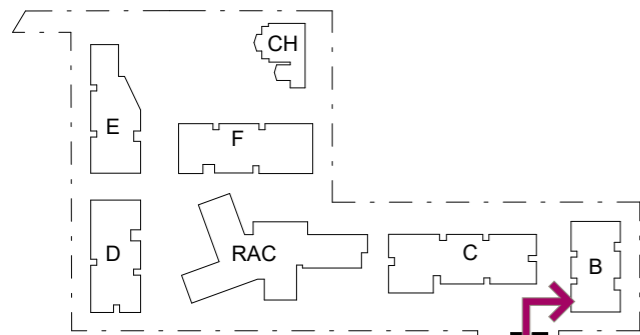

ISSUE A
 Date of Issue | 16.02.2024

70303 | UNITING CARE | 24A KINGSCLIFF STREET, KINGSCLIFF, NSW 2487

DATE	DESCRIPTION	BY	CHK	REV
16.02.2024	FOR DA SUBMISSION	VP	CLIENT & CST	A

DISCLAIMER
 In accepting and utilising this document the recipient agrees that Plus Architecture Pty. Ltd. ACN 091 690 336, retain all common law, statutory law and other rights including copyright and intellectual property rights. The recipient agrees not to use this document for any purpose other than its intended use; to waive all claims against Plus Architecture resulting from unauthorised changes; or to reuse the document on other projects without the prior written consent of Plus Architecture. Under no circumstances shall transfer of this document be deemed a sale. Plus Architecture makes no warranties of fitness for any purpose. The Builder/Contractor shall verify job dimensions prior to any work commencing. Figured dimensions shall take precedence over scaled work.



NOMINATED ARCHITECTS NSW - Amit Julka 10002; Rido Pin 11286
 Level 4, 222 Clarence Street
 Sydney NSW 2000
 sydney@plusarchitecture.com.au
 www.plusarchitecture.com.au
 TELEPHONE +61 2 8823 7000
 Plus Architecture Sydney Pty Ltd
 ACN 618393338

GROSS FLOOR AREA
536 m²

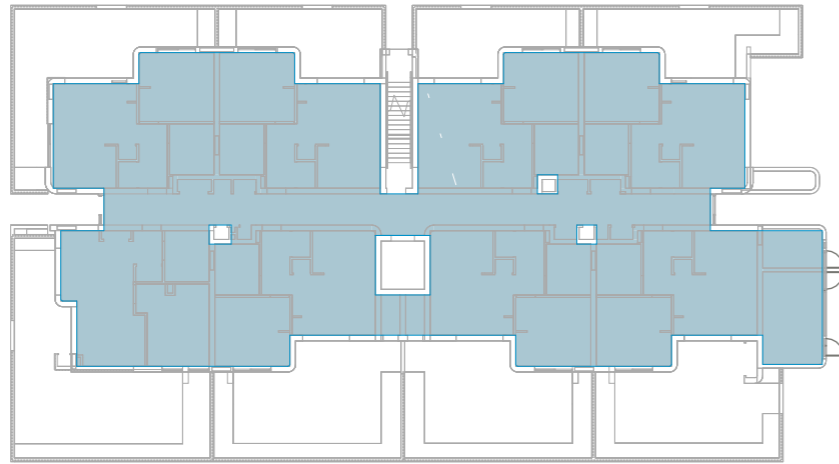

AREA PLAN (GFA)
GROUND FLOOR

GROSS FLOOR AREA
506 m²

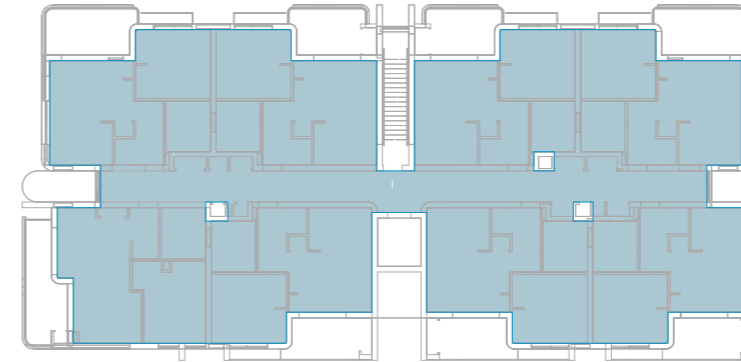

AREA PLAN (GFA)
LEVEL 01

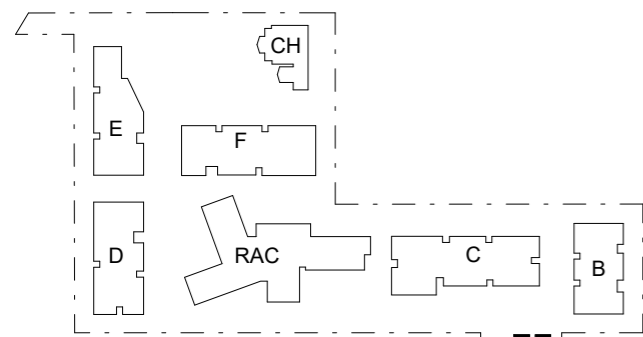

BUILDING A - GROUND FLOOR	536 m ²
BUILDING A - LEVEL 01	506 m ²
TOTAL GROSS FLOOR AREA	1041 m²

LEGENDS

GFA

4 0 4 8 12 16 20
SCALE 1:400 @ A3 SIZE m

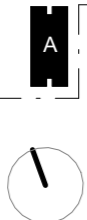

DATE	DESCRIPTION	BY	CHK	REV
31.01.2024	FOR DA SUBMISSION	VP	CLIENT & CST	A

DISCLAIMER
In accepting and utilising this document the recipient agrees that Plus Architecture Pty. Ltd. ACN 091 690 336, retain all common law, statutory law and other rights including copyright and intellectual property rights. The recipient agrees not to use this document for any purpose other than its intended use; to waive all claims against Plus Architecture resulting from unauthorised changes; or to reuse the document on other projects without the prior written consent of Plus Architecture. Under no circumstances shall transfer of this document be deemed a sale. Plus Architecture makes no warranties of fitness for any purpose. The Builder/Contractor shall verify job dimensions prior to any work commencing. Figured dimensions shall take precedence over scaled work.



NOTE: GFA IS ALSO USED TO CALCULATE FSR. LORIE WAY AND KINGSCLIFF ST SITES REQUIRE 2 DIFFERENT CALC'S. MAKE SURE TO SPLIT THE GFA FIGURES FOR BUILDING A, AS IT SITS ACROSS BOTH SITES.

ISSUE A
Date of Issue | 31.01.2024

70303 | UNITING CARE | 24A KINGSCLIFF STREET, KINGSCLIFF, NSW 2487

NOMINATED ARCHITECTS NSW - Amit Julka 10002; Rido Pin 11286
Level 4, 222 Clarence Street TELEPHONE +61 2 8823 7000
Sydney NSW 2000
sydney@plusarchitecture.com.au Plus Architecture Sydney Pty Ltd
www.plusarchitecture.com.au ACN 618393338

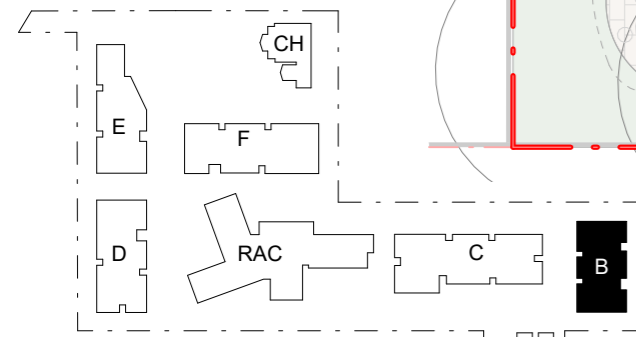
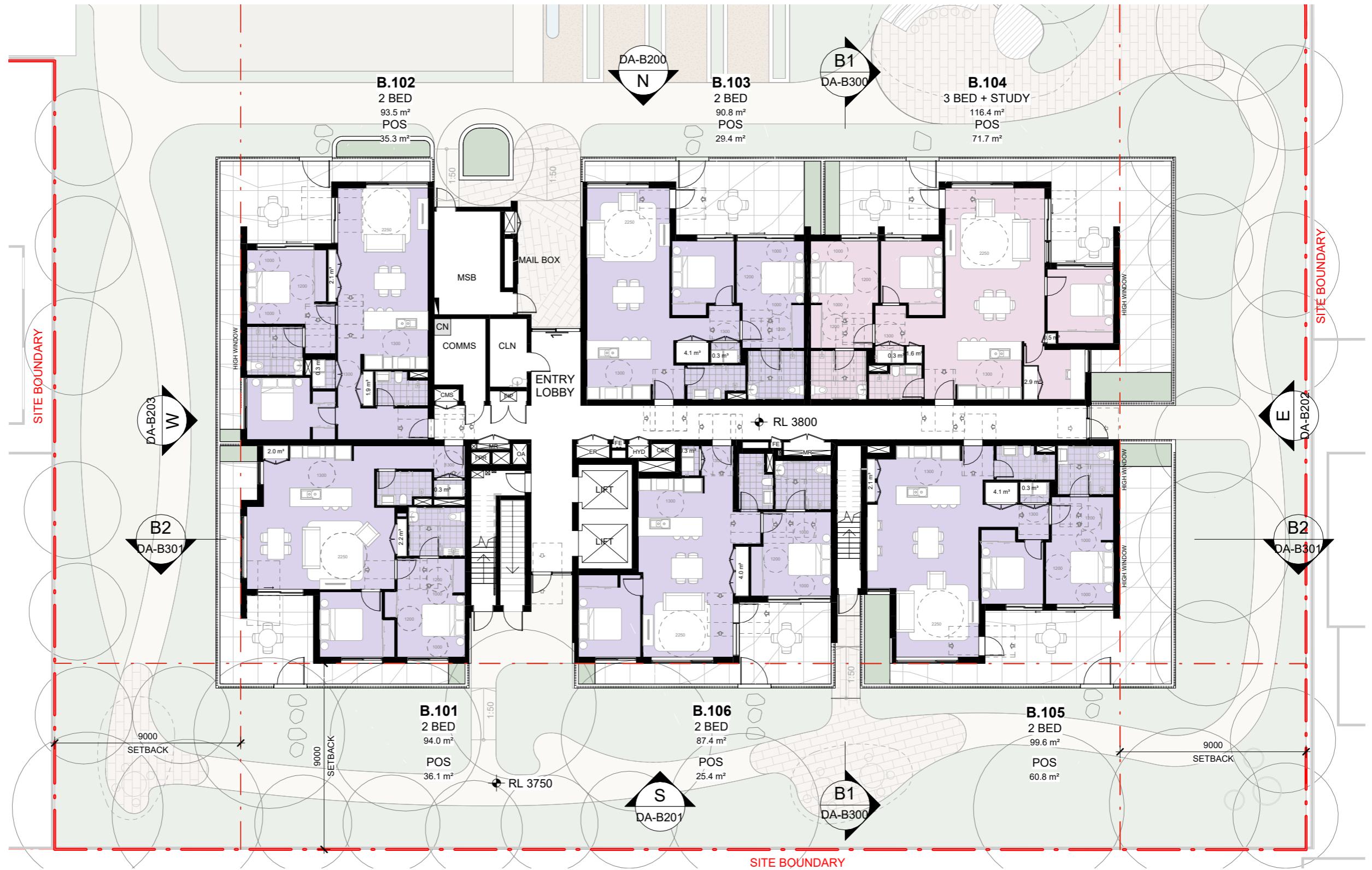

LEGEND

CER	CARPARK EXHAUST RISER	GE	CLN ROOM EXHAUST RISER
CSA	CARPARK SUPPLY AIR	HYD	HYDRAULIC RISER
ER	ELECTRICAL RISER	MR	MECHANICAL RISER
FE	FIRE EXTINGUISHER	OA	OUTSIDE AIR
FIP	FIRE INDICATOR PANEL	SC	SPRINKLER CONTROL

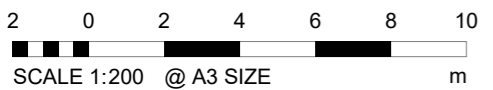

ISSUE A
Date of Issue | 31.01.2024

70303 | UNITING CARE | 24A KINGSCLIFF STREET, KINGSCLIFF, NSW 2487

DATE	DESCRIPTION	BY	CHK	REV
31.01.2024	FOR DA SUBMISSION	VP	CLIENT & CST	A

DISCLAIMER
In accepting and utilising this document the recipient agrees that Plus Architecture Pty. Ltd. ACN 091 690 336, retain all common law, statutory law and other rights including copyright and intellectual property rights. The recipient agrees not to use this document for any purpose other than its intended use; to waive all claims against Plus Architecture resulting from unauthorised changes; or to reuse the document on other projects without the prior written consent of Plus Architecture. Under no circumstances shall transfer of this document be deemed a sale. Plus Architecture makes no warranties of fitness for any purpose. The Builder/Contractor shall verify job dimensions prior to any work commencing. Figured dimensions shall take precedence over scaled work.



NOMINATED ARCHITECTS NSW - Amit Julka 10002; Rido Pin 11286
 Level 4, 222 Clarence Street
 Sydney NSW 2000
 sydney@plusarchitecture.com.au
 www.plusarchitecture.com.au
 TELEPHONE +61 2 8823 7000
 Plus Architecture Sydney Pty Ltd
 ACN 618393338

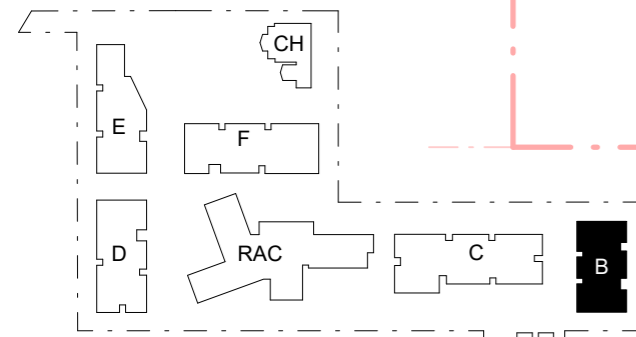

LEGEND

CER	CARPARK EXHAUST RISER	GE	CLN ROOM EXHAUST RISER
CSA	CARPARK SUPPLY AIR	HYD	HYDRAULIC RISER
ER	ELECTRICAL RISER	MR	MECHANICAL RISER
FE	FIRE EXTINGUISHER	OA	OUTSIDE AIR
FIP	FIRE INDICATOR PANEL	SC	SPRINKLER CONTROL

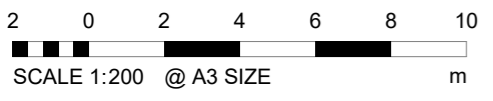

ISSUE A
Date of Issue | 31.01.2024

70303 | UNITING CARE | 24A KINGSCLIFF STREET, KINGSCLIFF, NSW 2487

DATE	DESCRIPTION	BY	CHK	REV
31.01.2024	FOR DA SUBMISSION	VP	CLIENT & CST	A

DISCLAIMER
In accepting and utilising this document the recipient agrees that Plus Architecture Pty. Ltd. ACN 091 690 336, retain all common law, statutory law and other rights including copyright and intellectual property rights. The recipient agrees not to use this document for any purpose other than its intended use; to waive all claims against Plus Architecture resulting from unauthorised changes; or to reuse the document on other projects without the prior written consent of Plus Architecture. Under no circumstances shall transfer of this document be deemed a sale. Plus Architecture makes no warranties of fitness for any purpose. The Builder/Contractor shall verify job dimensions prior to any work commencing. Figured dimensions shall take precedence over scaled work.



NOMINATED ARCHITECTS NSW - Amit Julka 10002; Rido Pin 11286
Level 4, 222 Clarence Street
Sydney NSW 2000
sydney@plusarchitecture.com.au
www.plusarchitecture.com.au
TELEPHONE +61 2 8823 7000
Plus Architecture Sydney Pty Ltd
ACN 618393338

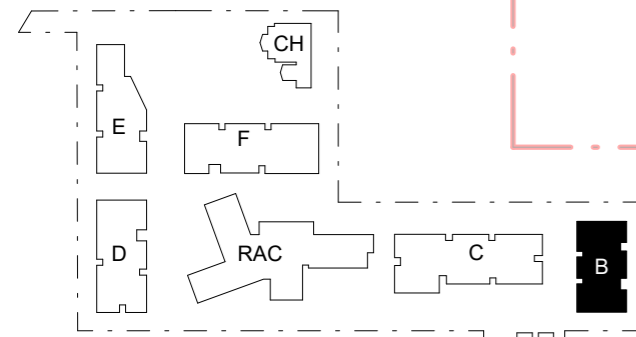

LEGEND

CER	CARPARK EXHAUST RISER	GE	CLN ROOM EXHAUST RISER
CSA	CARPARK SUPPLY AIR	HYD	HYDRAULIC RISER
ER	ELECTRICAL RISER	MR	MECHANICAL RISER
FE	FIRE EXTINGUISHER	OA	OUTSIDE AIR
FIP	FIRE INDICATOR PANEL	SC	SPRINKLER CONTROL

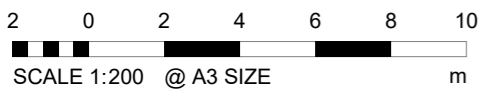

ISSUE A
Date of Issue | 31.01.2024

DATE	DESCRIPTION	BY	CHK	REV
31.01.2024	FOR DA SUBMISSION	VP	CLIENT & CST	A

DISCLAIMER
In accepting and utilising this document the recipient agrees that Plus Architecture Pty. Ltd. ACN 091 690 336, retain all common law, statutory law and other rights including copyright and intellectual property rights. The recipient agrees not to use this document for any purpose other than its intended use; to waive all claims against Plus Architecture resulting from unauthorised changes; or to reuse the document on other projects without the prior written consent of Plus Architecture. Under no circumstances shall transfer of this document be deemed a sale. Plus Architecture makes no warranties of fitness for any purpose. The Builder/Contractor shall verify job dimensions prior to any work commencing. Figured dimensions shall take precedence over scaled work.



NOMINATED ARCHITECTS NSW - Amit Julka 10002; Rido Pin 11286
Level 4, 222 Clarence Street
Sydney NSW 2000
sydney@plusarchitecture.com.au
www.plusarchitecture.com.au
TELEPHONE +61 2 8823 7000
Plus Architecture Sydney Pty Ltd
ACN 618393338

DRAWING TO BE READ IN CONJUNCTION WITH A0000 LEGEND, RELEVANT SCHEDULES AND PROJECT SPECIFICATION. REFER TO LANDSCAPE ARCHITECT'S DRAWINGS FOR LANDSCAPE AREA DETAILS

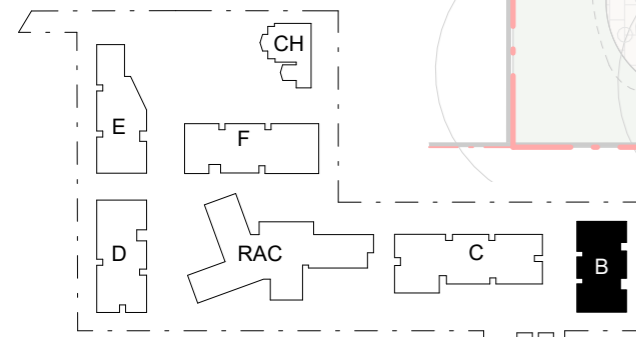
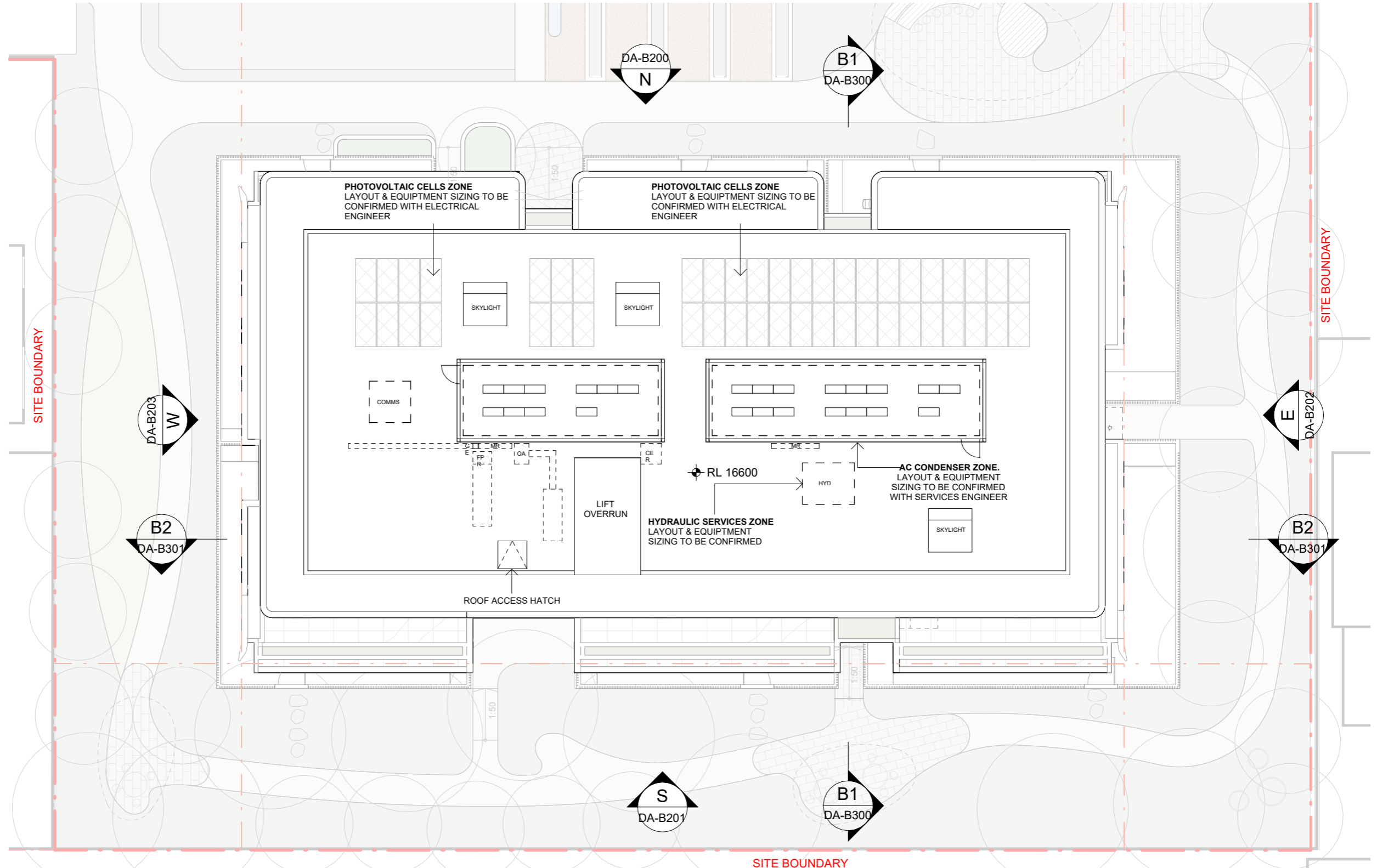

LEGEND

CER	CARPARK EXHAUST RISER	GE	CLN ROOM EXHAUST RISER
CSA	CARPARK SUPPLY AIR	HYD	HYDRAULIC RISER
ER	ELECTRICAL RISER	MR	MECHANICAL RISER
FE	FIRE EXTINGUISHER	OA	OUTSIDE AIR
FIP	FIRE INDICATOR PANEL	SC	SPRINKLER CONTROL

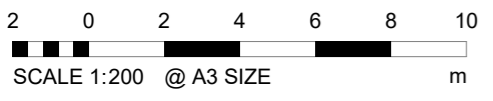

DATE	DESCRIPTION	BY	CHK	REV
31.01.2024	FOR DA SUBMISSION	VP	CLIENT & CST	A

DISCLAIMER
 In accepting and utilising this document the recipient agrees that Plus Architecture Pty. Ltd. ACN 091 690 336, retain all common law, statutory law and other rights including copyright and intellectual property rights. The recipient agrees not to use this document for any purpose other than its intended use; to waive all claims against Plus Architecture resulting from unauthorised changes; or to reuse the document on other projects without the prior written consent of Plus Architecture. Under no circumstances shall transfer of this document be deemed a sale. Plus Architecture makes no warranties of fitness for any purpose. The Builder/Contractor shall verify job dimensions prior to any work commencing. Figured dimensions shall take precedence over scaled work.



NOMINATED ARCHITECTS NSW - Amit Julka 10002; Rido Pin 11286
 Level 4, 222 Clarence Street
 Sydney NSW 2000
 sydney@plusarchitecture.com.au
 www.plusarchitecture.com.au
 TELEPHONE +61 2 8823 7000
 Plus Architecture Sydney Pty Ltd
 ACN 618393338

ISSUE A
 Date of Issue | 31.01.2024

70303 | UNITING CARE | 24A KINGSCLIFF STREET, KINGSCLIFF, NSW 2487

JANUARY 2024 | DEVELOPMENT APPLICATION | PLUS ARCHITECTURE

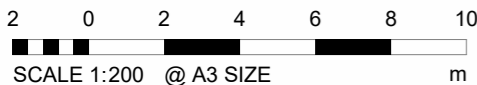
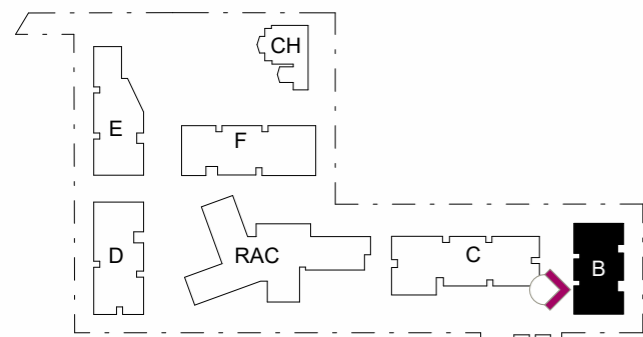

ISSUE A
Date of Issue | 16.02.2024

DATE	DESCRIPTION	BY	CHK	REV
16.02.2024	FOR DA SUBMISSION	VP	CLIENT & CST	A

DISCLAIMER
In accepting and utilising this document the recipient agrees that Plus Architecture Pty. Ltd. ACN 091 690 336, retain all common law, statutory law and other rights including copyright and intellectual property rights. The recipient agrees not to use this document for any purpose other than its intended use; to waive all claims against Plus Architecture resulting from unauthorised changes; or to reuse the document on other projects without the prior written consent of Plus Architecture. Under no circumstances shall transfer of this document be deemed a sale. Plus Architecture makes no warranties of fitness for any purpose. The Builder/Contractor shall verify job dimensions prior to any work commencing. Figured dimensions shall take precedence over scaled work.



EXTERNAL FINISHES LEGEND

- BR1 BRICK TYPE 1
- BR2 BRICK TYPE 2
- BR3 BRICK TYPE 3
- BR4 BRICK TYPE 4
- GL1 GLAZING
- GL2 FRITTED GLAZING
- M1 METAL FINISH - CHARCOAL
- M2 METAL FINISH - BRONZE
- M3 METAL CLADDING - CHARCOAL
- M4 METAL CLADDING - GREY
- M5 METAL CLADDING - BRONZE
- P1 PAINT FINISH - DARK CHARCOAL
- P2 PAINT FINISH - GREY
- P3 PAINT FINISH - OFF WHITE
- P4 PAINT FINISH - TO MATCH M2
- P5 PAINT FINISH - OFF WHITE
- ST1 VERTICAL SCORING PRE-FINISHED FC CLADDING

NOMINATED ARCHITECTS NSW - Amit Julka 10002; Rido Pin 11286
Level 4, 222 Clarence Street TELEPHONE +61 2 8823 7000
Sydney NSW 2000
sydney@plusarchitecture.com.au Plus Architecture Sydney Pty Ltd
www.plusarchitecture.com.au ACN 618393338

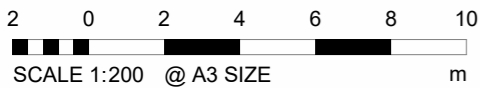

ISSUE A
Date of Issue | 16.02.2024

70303 | UNITING CARE | 24A KINGSCLIFF STREET, KINGSCLIFF, NSW 2487

DATE	DESCRIPTION	BY	CHK	REV
16.02.2024	FOR DA SUBMISSION	VP	CLIENT & CST	A

DISCLAIMER
In accepting and utilising this document the recipient agrees that Plus Architecture Pty. Ltd. ACN 091 690 336, retain all common law, statutory law and other rights including copyright and intellectual property rights. The recipient agrees not to use this document for any purpose other than its intended use; to waive all claims against Plus Architecture resulting from unauthorised changes; or to reuse the document on other projects without the prior written consent of Plus Architecture. Under no circumstances shall transfer of this document be deemed a sale. Plus Architecture makes no warranties of fitness for any purpose. The Builder/Contractor shall verify job dimensions prior to any work commencing. Figured dimensions shall take precedence over scaled work.



EXTERNAL FINISHES LEGEND

- BR1** BRICK TYPE 1
- BR2** BRICK TYPE 2
- BR3** BRICK TYPE 3
- BR4** BRICK TYPE 4
- GL1** GLAZING
- GL2** FRITTED GLAZING
- M1** METAL FINISH - CHARCOAL
- M2** METAL FINISH - BRONZE
- M3** METAL CLADDING - CHARCOAL
- M4** METAL CLADDING - GREY
- M5** METAL CLADDING - BRONZE
- P1** PAINT FINISH - DARK CHARCOAL
- P2** PAINT FINISH - GREY
- P3** PAINT FINISH - OFF WHITE
- P4** PAINT FINISH - TO MATCH M2
- P5** PAINT FINISH - OFF WHITE
- ST1** VERTICAL SCORING PRE-FINISHED FC CLADDING

NOMINATED ARCHITECTS NSW - Amit Julka 10002; Rido Pin 11286
 Level 4, 222 Clarence Street TELEPHONE +61 2 8823 7000
 Sydney NSW 2000 Plus Architecture Sydney Pty Ltd
 sydney@plusarchitecture.com.au www.plusarchitecture.com.au ACN 618393338

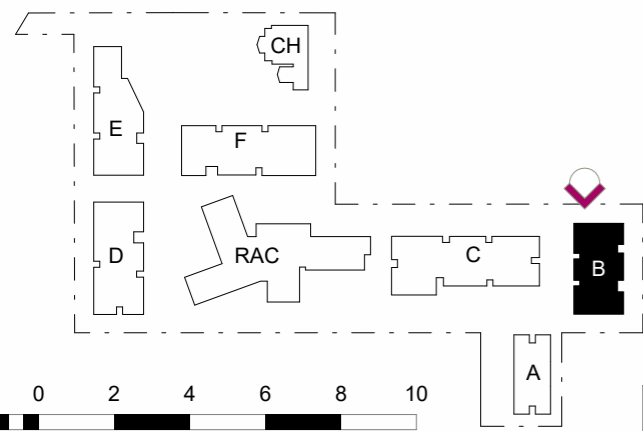
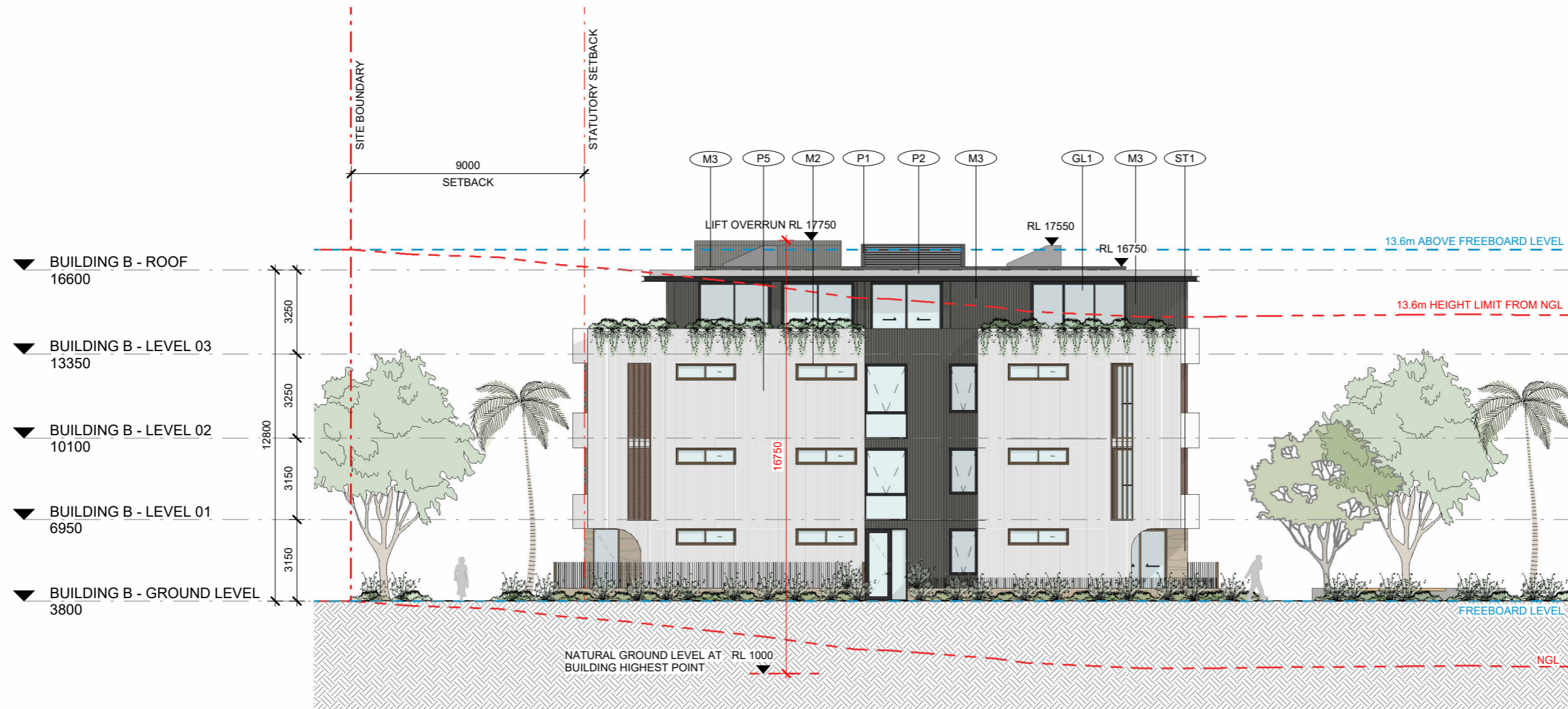

SCALE 1:200 @ A3 SIZE

ISSUE A
Date of Issue | 16.02.2024

70303 | UNITING CARE | 24A KINGSCLIFF STREET, KINGSCLIFF, NSW 2487

DATE	DESCRIPTION	BY	CHK	REV
16.02.2024	FOR DA SUBMISSION	VP	CLIENT & CST	A

DISCLAIMER
In accepting and utilising this document the recipient agrees that Plus Architecture Pty. Ltd. ACN 091 690 336, retain all common law, statutory law and other rights including copyright and intellectual property rights. The recipient agrees not to use this document for any purpose other than its intended use; to waive all claims against Plus Architecture resulting from unauthorised changes; or to reuse the document on other projects without the prior written consent of Plus Architecture. Under no circumstances shall transfer of this document be deemed a sale. Plus Architecture makes no warranties of fitness for any purpose. The Builder/Contractor shall verify job dimensions prior to any work commencing. Figured dimensions shall take precedence over scaled work.



EXTERNAL FINISHES LEGEND

- BR1** BRICK TYPE 1
- BR2** BRICK TYPE 2
- BR3** BRICK TYPE 3
- BR4** BRICK TYPE 4
- GL1** GLAZING
- GL2** FRITTED GLAZING
- M1** METAL FINISH - CHARCOAL
- M2** METAL FINISH - BRONZE
- M3** METAL CLADDING - CHARCOAL
- M4** METAL CLADDING - GREY
- M5** METAL CLADDING - BRONZE
- P1** PAINT FINISH - DARK CHARCOAL
- P2** PAINT FINISH - GREY
- P3** PAINT FINISH - OFF WHITE
- P4** PAINT FINISH - TO MATCH M2
- P5** PAINT FINISH - OFF WHITE
- ST1** VERTICAL SCORING PRE-FINISHED FC CLADDING

NOMINATED ARCHITECTS NSW - Amit Julka 10002; Rido Pin 11286
Level 4, 222 Clarence Street TELEPHONE +61 2 8823 7000
Sydney NSW 2000
sydney@plusarchitecture.com.au Plus Architecture Sydney Pty Ltd
www.plusarchitecture.com.au ACN 618393338

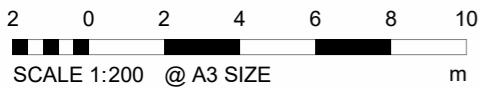
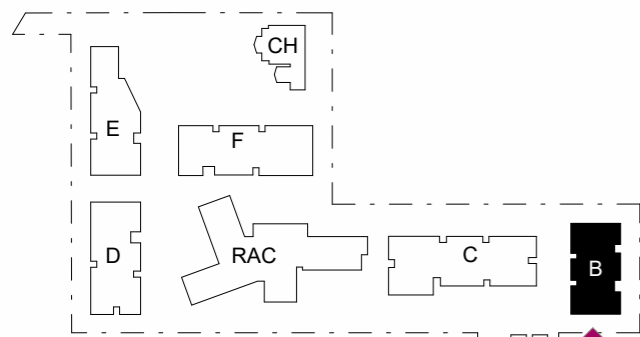

ISSUE A
Date of Issue | 16.02.2024

70303 | UNITING CARE | 24A KINGSCLIFF STREET, KINGSCLIFF, NSW 2487

DATE	DESCRIPTION	BY	CHK	REV
16.02.2024	FOR DA SUBMISSION	VP	CLIENT & CST	A

DISCLAIMER
 In accepting and utilising this document the recipient agrees that Plus Architecture Pty. Ltd. ACN 091 690 336, retain all common law, statutory law and other rights including copyright and intellectual property rights. The recipient agrees not to use this document for any purpose other than its intended use; to waive all claims against Plus Architecture resulting from unauthorised changes; or to reuse the document on other projects without the prior written consent of Plus Architecture. Under no circumstances shall transfer of this document be deemed a sale. Plus Architecture makes no warranties of fitness for any purpose. The Builder/Contractor shall verify job dimensions prior to any work commencing. Figured dimensions shall take precedence over scaled work.



EXTERNAL FINISHES LEGEND

- BR1** BRICK TYPE 1
- BR2** BRICK TYPE 2
- BR3** BRICK TYPE 3
- BR4** BRICK TYPE 4
- GL1** GLAZING
- GL2** FRITTED GLAZING
- M1** METAL FINISH - CHARCOAL
- M2** METAL FINISH - BRONZE
- M3** METAL CLADDING - CHARCOAL
- M4** METAL CLADDING - GREY
- M5** METAL CLADDING - BRONZE
- P1** PAINT FINISH - DARK CHARCOAL
- P2** PAINT FINISH - GREY
- P3** PAINT FINISH - OFF WHITE
- P4** PAINT FINISH - TO MATCH M2
- P5** PAINT FINISH - OFF WHITE
- ST1** VERTICAL SCORING
- ST1** PRE-FINISHED FC CLADDING

NOMINATED ARCHITECTS NSW - Amit Julka 10002; Rido Pin 11286
 Level 4, 222 Clarence Street TELEPHONE +61 2 8823 7000
 Sydney NSW 2000
 sydney@plusarchitecture.com.au Plus Architecture Sydney Pty Ltd
 www.plusarchitecture.com.au ACN 618393338

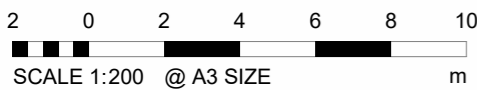
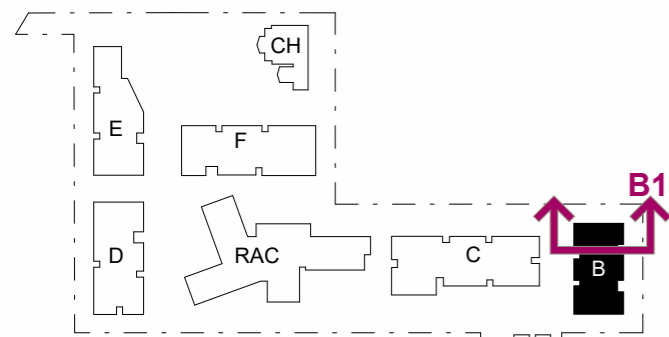
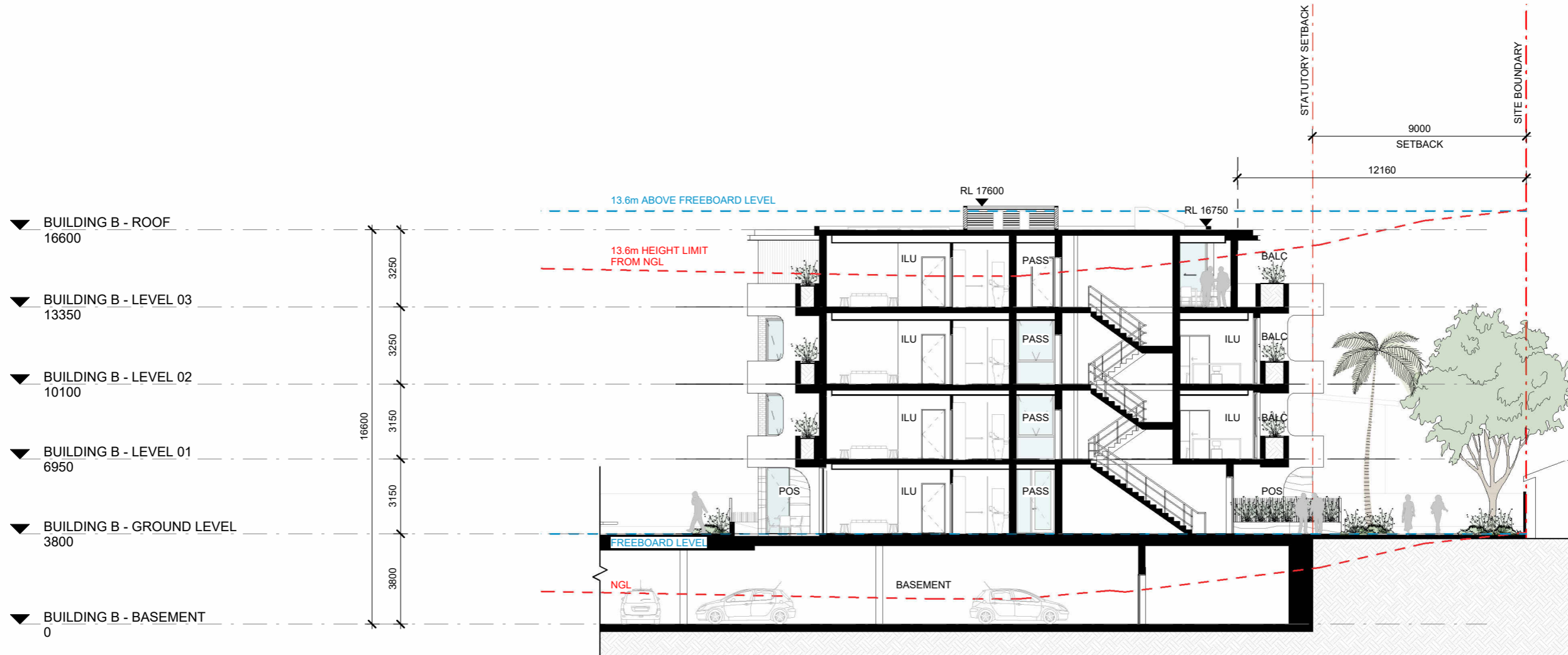

ISSUE A
Date of Issue | 16.02.2024

DATE	DESCRIPTION	BY	CHK	REV
16.02.2024	FOR DA SUBMISSION	VP	CLIENT & CST	A

DISCLAIMER
In accepting and utilising this document the recipient agrees that Plus Architecture Pty. Ltd. ACN 091 690 336, retain all common law, statutory law and other rights including copyright and intellectual property rights. The recipient agrees not to use this document for any purpose other than its intended use; to waive all claims against Plus Architecture resulting from unauthorised changes; or to reuse the document on other projects without the prior written consent of Plus Architecture. Under no circumstances shall transfer of this document be deemed a sale. Plus Architecture makes no warranties of fitness for any purpose. The Builder/Contractor shall verify job dimensions prior to any work commencing. Figured dimensions shall take precedence over scaled work.



NOMINATED ARCHITECTS NSW - Amit Julka 10002; Rido Pin 11286
 Level 4, 222 Clarence Street TELEPHONE +61 2 8823 7000
 Sydney NSW 2000 Plus Architecture Sydney Pty Ltd
 sydney@plusarchitecture.com.au www.plusarchitecture.com.au ACN 618393338

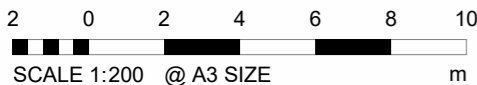
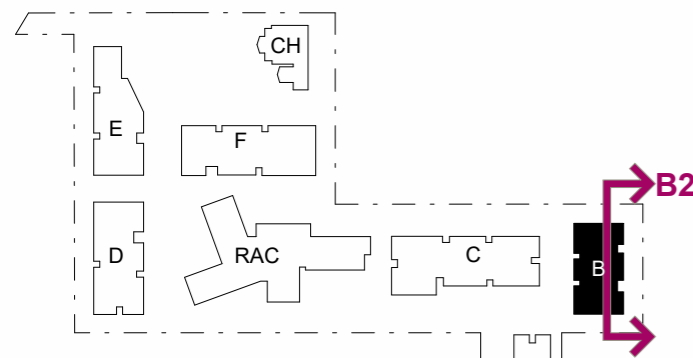
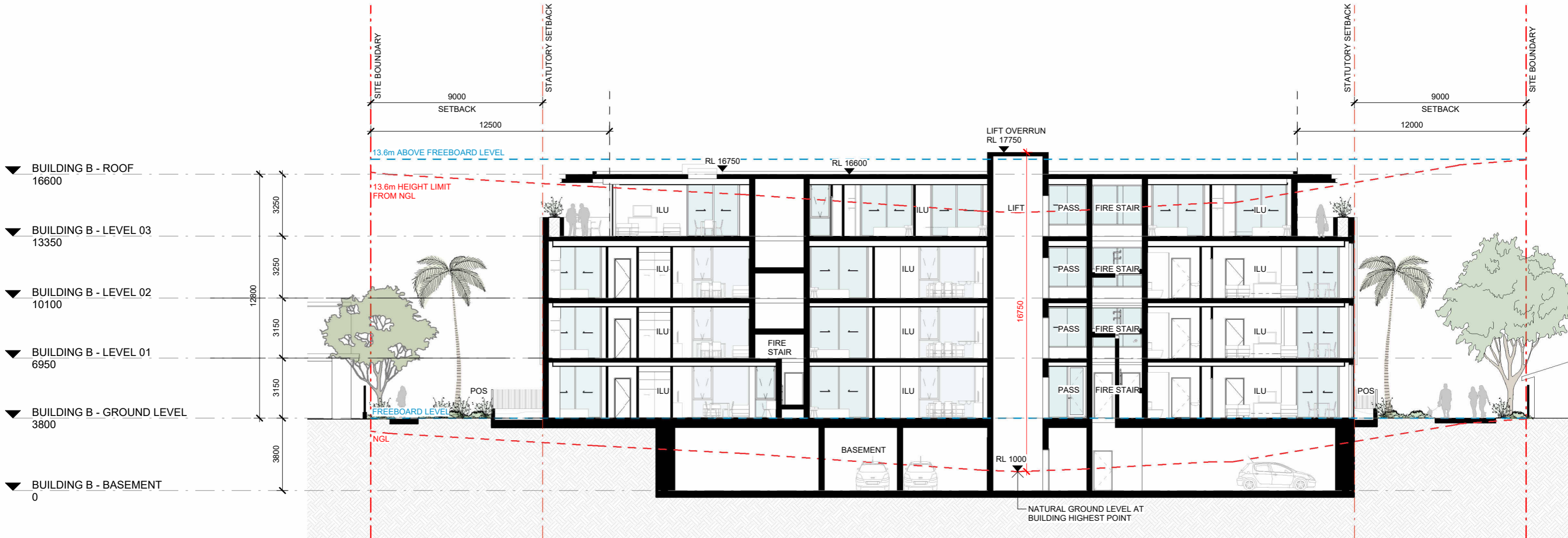

ISSUE A
Date of Issue | 16.02.2024

70303 | UNITING CARE | 24A KINGSCLIFF STREET, KINGSCLIFF, NSW 2487

DATE	DESCRIPTION	BY	CHK	REV
16.02.2024	FOR DA SUBMISSION	VP	CLIENT & CST	A

DISCLAIMER
In accepting and utilising this document the recipient agrees that Plus Architecture Pty. Ltd. ACN 091 690 336, retain all common law, statutory law and other rights including copyright and intellectual property rights. The recipient agrees not to use this document for any purpose other than its intended use; to waive all claims against Plus Architecture resulting from unauthorised changes; or to reuse the document on other projects without the prior written consent of Plus Architecture. Under no circumstances shall transfer of this document be deemed a sale. Plus Architecture makes no warranties of fitness for any purpose. The Builder/Contractor shall verify job dimensions prior to any work commencing. Figured dimensions shall take precedence over scaled work.



NOMINATED ARCHITECTS NSW - Amit Julka 10002; Rido Pin 11286
 Level 4, 222 Clarence Street
 Sydney NSW 2000
 sydney@plusarchitecture.com.au
 www.plusarchitecture.com.au
 TELEPHONE +61 2 8823 7000
 Plus Architecture Sydney Pty Ltd
 ACN 618393338

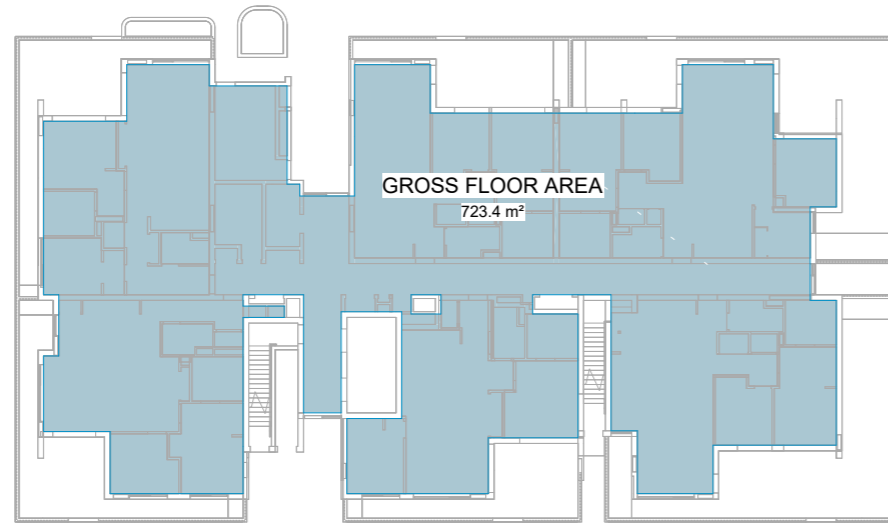

AREA PLAN (GFA)
GROUND FLOOR

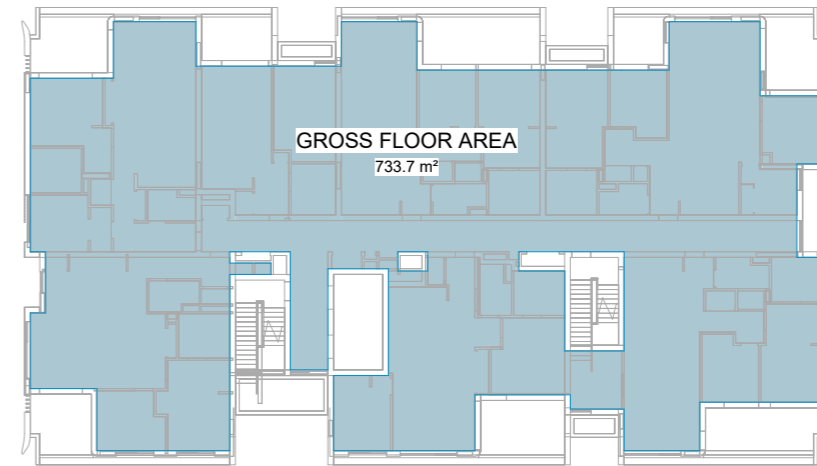

AREA PLAN (GFA)
LEVEL 01 - 02

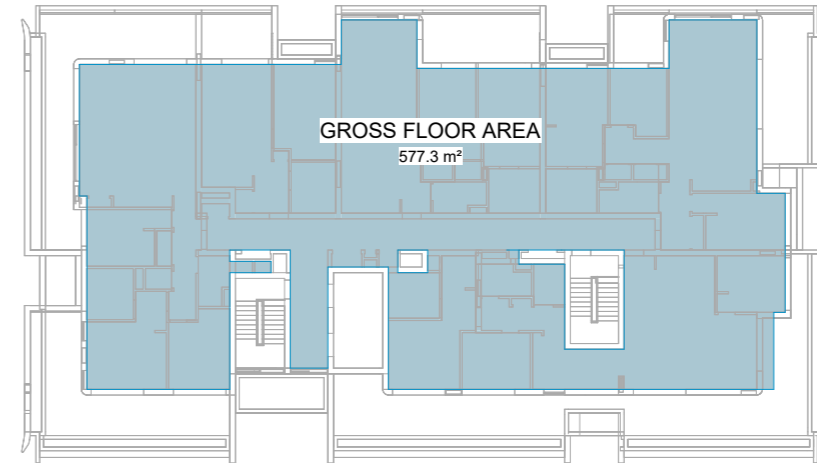

DA BUILDING B - AREA PLAN - GFA - LEVEL 03
LEVEL 03

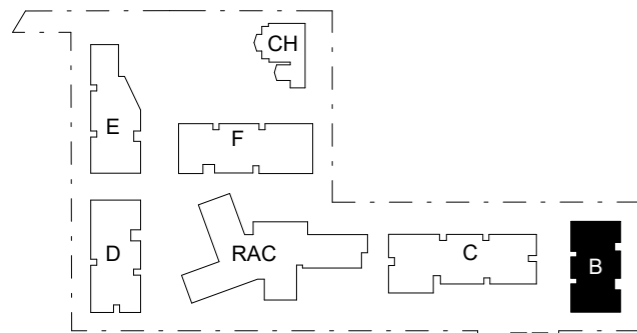

BUILDING B - GROUND LEVEL	723.4 m ²
BUILDING B - LEVEL 01	733.7 m ²
BUILDING B - LEVEL 02	733.7 m ²
BUILDING B - LEVEL 03	577.3 m ²
TOTAL GROSS FLOOR AREA	2768.1 m²

LEGENDS

GFA

4 0 4 8 12 16 20
SCALE 1:400 @ A3 SIZE m



ISSUE A
Date of Issue | 31.01.2024

70303 | UNITING CARE | 24A KINGSCLIFF STREET, KINGSCLIFF, NSW 2487

DATE	DESCRIPTION	BY	CHK	REV
31.01.2024	FOR DA SUBMISSION	VP	CLIENT & CST	A

DISCLAIMER
In accepting and utilising this document the recipient agrees that Plus Architecture Pty. Ltd. ACN 091 690 336, retain all common law, statutory law and other rights including copyright and intellectual property rights. The recipient agrees not to use this document for any purpose other than its intended use; to waive all claims against Plus Architecture resulting from unauthorised changes; or to reuse the document on other projects without the prior written consent of Plus Architecture. Under no circumstances shall transfer of this document be deemed a sale. Plus Architecture makes no warranties of fitness for any purpose. The Builder/Contractor shall verify job dimensions prior to any work commencing. Figured dimensions shall take precedence over scaled work.

Uniting

plus
architecture

NOMINATED ARCHITECTS NSW - Amit Julka 10002; Rido Pin 11286
Level 4, 222 Clarence Street TELEPHONE +61 2 8823 7000
Sydney NSW 2000
sydney@plusarchitecture.com.au Plus Architecture Sydney Pty Ltd
www.plusarchitecture.com.au ACN 618393338

PLA-DRW-DA-C100

BUILDING C

FLOOR PLAN - GROUND LEVEL

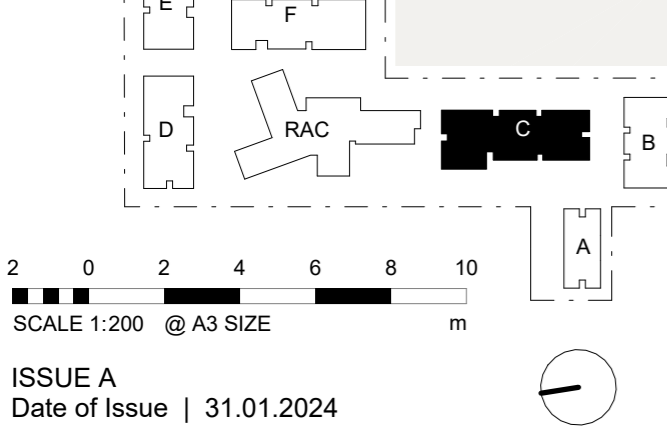
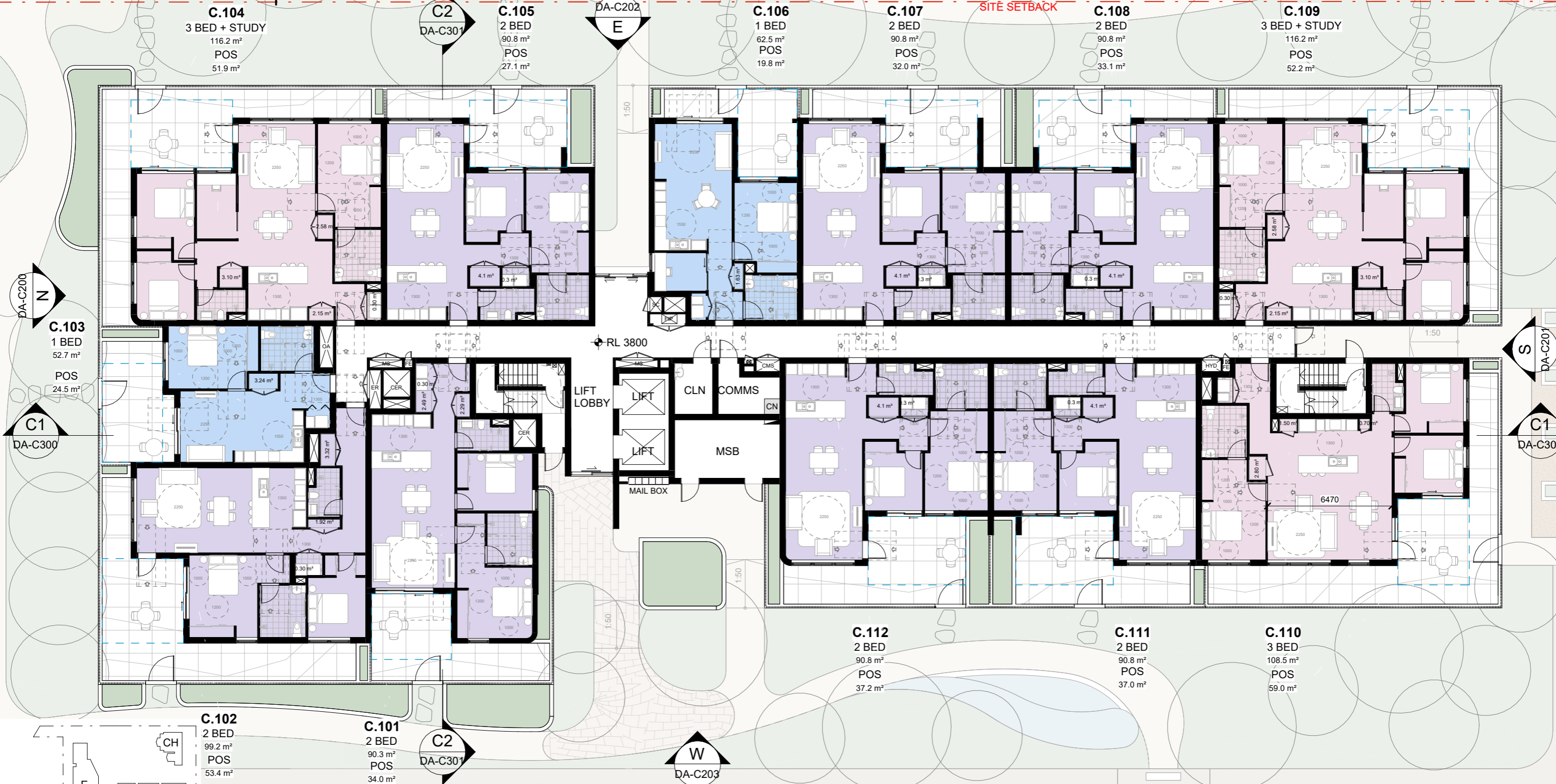

- LEGEND**
- CER CARPARK EXHAUST RISER
 - CSA CARPARK SUPPLY AIR
 - ER ELECTRICAL RISER
 - FE FIRE EXTINGUISHER
 - FIP FIRE INDICATOR PANEL
 - GE CLN ROOM EXHAUST RISER
 - HYD HYDRAULIC RISER
 - MR MECHANICAL RISER
 - OA OUTSIDE AIR
 - SC SPRINKLER CONTROL

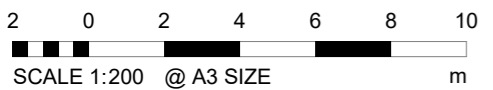

ISSUE A
Date of Issue | 31.01.2024

70303 | UNITING CARE | 24A KINGSCLIFF STREET, KINGSCLIFF, NSW 2487

DATE	DESCRIPTION	BY	CHK	REV
31.01.2024	FOR DA SUBMISSION	VP	CLIENT & CST	A

DISCLAIMER
In accepting and utilising this document the recipient agrees that Plus Architecture Pty. Ltd. ACN 091 690 336, retain all common law, statutory law and other rights including copyright and intellectual property rights. The recipient agrees not to use this document for any purpose other than its intended use; to waive all claims against Plus Architecture resulting from unauthorised changes; or to reuse the document on other projects without the prior written consent of Plus Architecture. Under no circumstances shall transfer of this document be deemed a sale. Plus Architecture makes no warranties of fitness for any purpose. The Builder/Contractor shall verify job dimensions prior to any work commencing. Figured dimensions shall take precedence over scaled work.



NOMINATED ARCHITECTS NSW - Amit Julka 10002; Rido Pin 11286
 Level 4, 222 Clarence Street
 Sydney NSW 2000
 sydney@plusarchitecture.com.au
 www.plusarchitecture.com.au
 TELEPHONE +61 2 8823 7000
 Plus Architecture Sydney Pty Ltd
 ACN 618393338

C.204
3 BED + STUDY
116.2 m²
BALCONY
13.6 m²

C2
DA-C301

C.205
2 BED
90.8 m²
BALCONY
12.2 m²

DA-C202
E

C.206
2 BED
90.8 m²
BALCONY
12.2 m²

C.207
2 BED
90.8 m²
BALCONY
12.2 m²

SITE SETBACK

C.208
2 BED
90.8 m²
BALCONY
12.2 m²

C.209
3 BED + STUDY
116.2 m²
BALCONY
13.6 m²



DA-C200
N

C.203
1 BED
52.7 m²
BALCONY
8.3 m²

C1
DA-C300

S
DA-C201

C1
DA-C300

C.202
1 BED
99.2 m²
BALCONY
11.8 m²

C2
DA-C301

C.201
2 BED
90.9 m²
BALCONY
10.5 m²

W
DA-C203

C.213
1 BED
57.6 m²
BALCONY
10.0 m²

C.212
2 BED
90.8 m²
BALCONY
16.0 m²

C.211
2 BED
90.8 m²
BALCONY
12.2 m²

C.210
3 BED
108.6 m²
BALCONY
12.9 m²

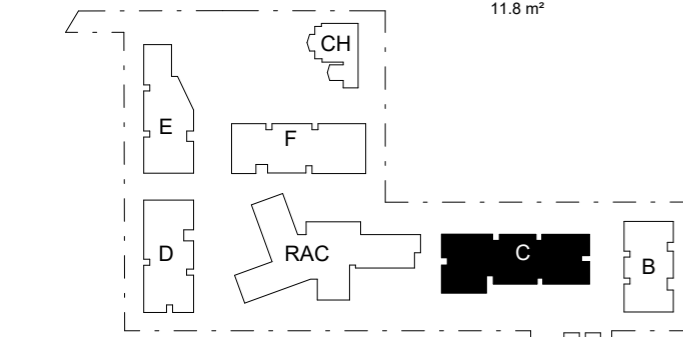

LEGEND

- CER CARPARK EXHAUST RISER
- CSA CARPARK SUPPLY AIR
- ER ELECTRICAL RISER
- FE FIRE EXTINGUISHER
- FIP FIRE INDICATOR PANEL
- GE CLN ROOM EXHAUST RISER
- HYD HYDRAULIC RISER
- MR MECHANICAL RISER
- OA OUTSIDE AIR
- SC SPRINKLER CONTROL

SITE SETBACK

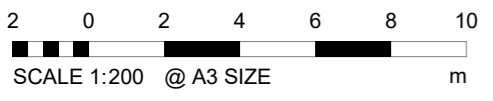

ISSUE A
Date of Issue | 31.01.2024

70303 | UNITING CARE | 24A KINGSCLIFF STREET, KINGSCLIFF, NSW 2487

DATE	DESCRIPTION	BY	CHK	REV
31.01.2024	FOR DA SUBMISSION	VP	CLIENT & CST	A

DISCLAIMER
In accepting and utilising this document the recipient agrees that Plus Architecture Pty. Ltd. ACN 091 690 336, retain all common law, statutory law and other rights including copyright and intellectual property rights. The recipient agrees not to use this document for any purpose other than its intended use; to waive all claims against Plus Architecture resulting from unauthorised changes; or to reuse the document on other projects without the prior written consent of Plus Architecture. Under no circumstances shall transfer of this document be deemed a sale. Plus Architecture makes no warranties of fitness for any purpose. The Builder/Contractor shall verify job dimensions prior to any work commencing. Figured dimensions shall take precedence over scaled work.



NOMINATED ARCHITECTS NSW - Amit Julka 10002; Rido Pin 11286
Level 4, 222 Clarence Street
Sydney NSW 2000
sydney@plusarchitecture.com.au
www.plusarchitecture.com.au
TELEPHONE +61 2 8823 7000
Plus Architecture Sydney Pty Ltd
ACN 618393338

C.403
3 BED
114.4 m²
BALCONY
41.9 m²

C.404
2 BED
99.0 m²
BALCONY
29.3 m²

C.405
2 BED
99.0 m²
BALCONY
29.4 m²

C.406
3 BED
114.4 m²
BALCONY
41.9 m²

C.402
2 BED
95.8 m²
BALCONY
18.6 m²

C.401
2 BED
89.9 m²
BALCONY
25.5 m²

C.410
1 BED
56.7 m²
BALCONY
10.0 m²

C.409
2 BED
90.8 m²
BALCONY
15.2 m²

C.408
2 BED
90.8 m²
BALCONY
11.5 m²

C.407
3 BED
108.5 m²
BALCONY
12.9 m²

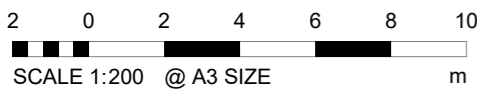
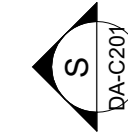
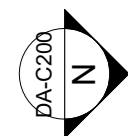
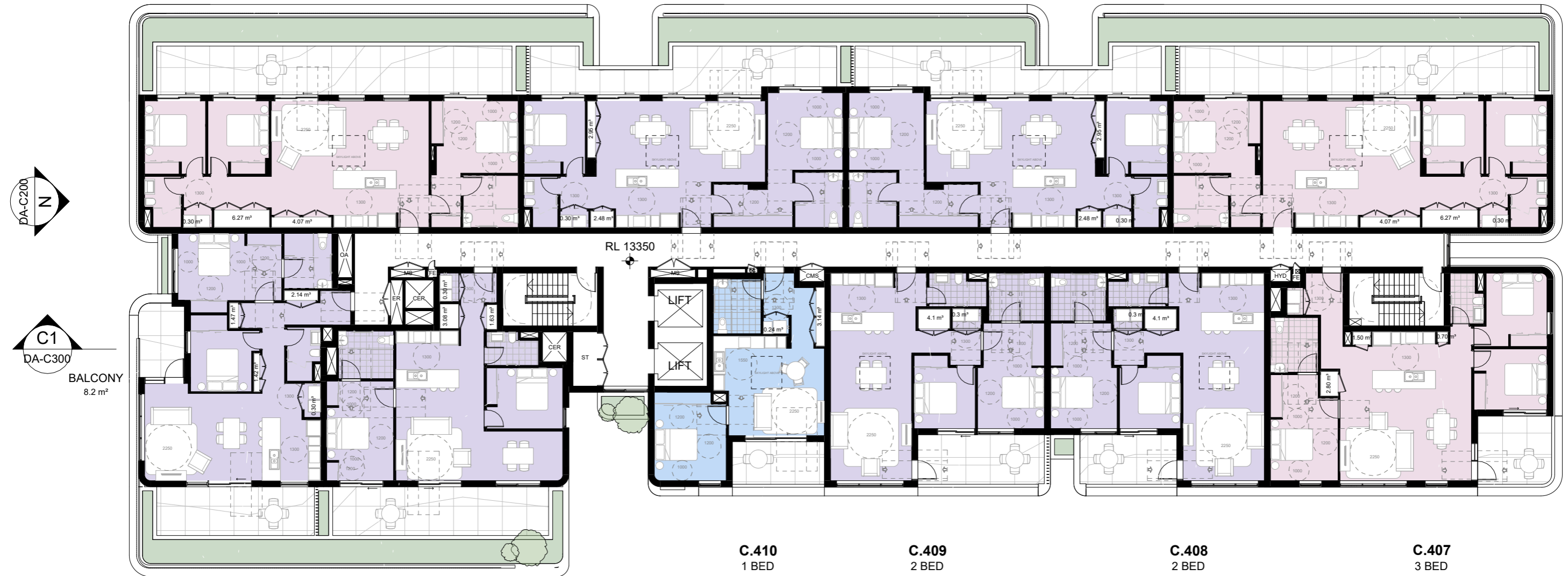

ISSUE A
Date of Issue | 31.01.2024

70303 | UNITING CARE | 24A KINGSCLIFF STREET, KINGSCLIFF, NSW 2487

LEGEND

- CER CARPARK EXHAUST RISER
- CSA CARPARK SUPPLY AIR
- ER ELECTRICAL RISER
- FE FIRE EXTINGUISHER
- FIP FIRE INDICATOR PANEL
- GE CLN ROOM EXHAUST RISER
- HYD HYDRAULIC RISER
- MR MECHANICAL RISER
- OA OUTSIDE AIR
- SC SPRINKLER CONTROL

DATE	DESCRIPTION	BY	CHK	REV
31.01.2024	FOR DA SUBMISSION	VP	CLIENT & CST	A

DISCLAIMER
In accepting and utilising this document the recipient agrees that Plus Architecture Pty. Ltd. ACN 091 690 336, retain all common law, statutory law and other rights including copyright and intellectual property rights. The recipient agrees not to use this document for any purpose other than its intended use; to waive all claims against Plus Architecture resulting from unauthorised changes; or to reuse the document on other projects without the prior written consent of Plus Architecture. Under no circumstances shall transfer of this document be deemed a sale. Plus Architecture makes no warranties of fitness for any purpose. The Builder/Contractor shall verify job dimensions prior to any work commencing. Figured dimensions shall take precedence over scaled work.



NOMINATED ARCHITECTS NSW - Amit Julka 10002; Rido Pin 11286
Level 4, 222 Clarence Street
Sydney NSW 2000
sydney@plusarchitecture.com.au
www.plusarchitecture.com.au
TELEPHONE +61 2 8823 7000
Plus Architecture Sydney Pty Ltd
ACN 618393338

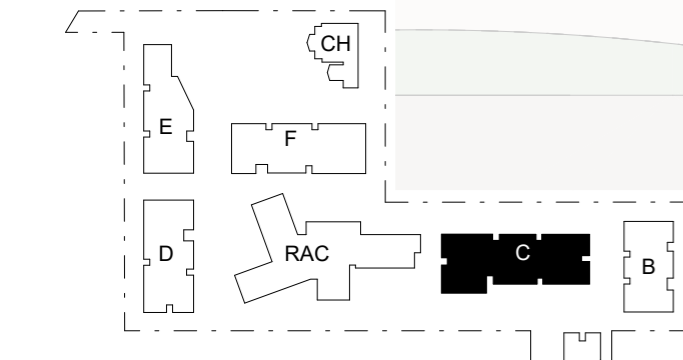
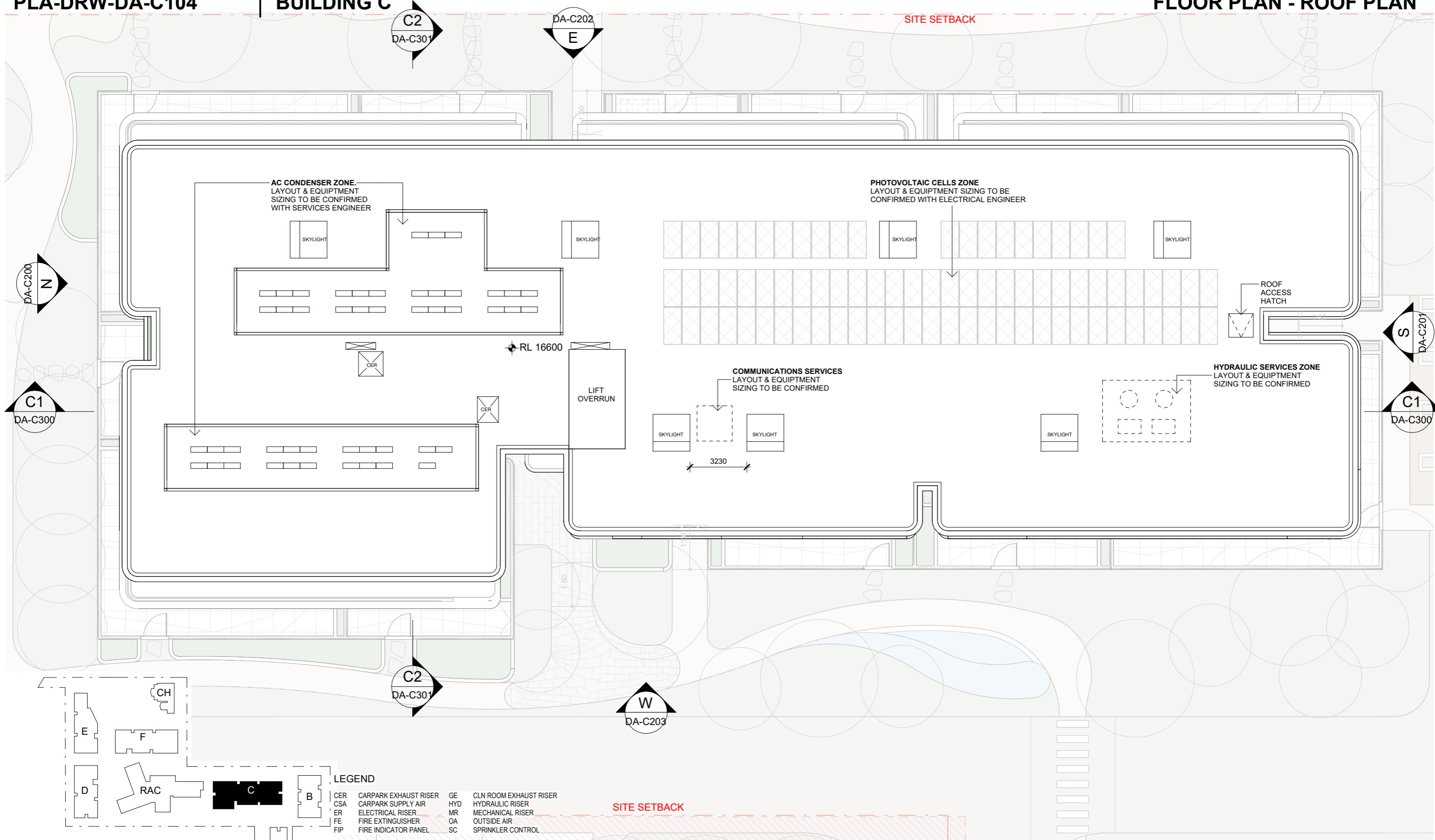

LEGEND

CER	CARPARK EXHAUST RISER	GE	CLN ROOM EXHAUST RISER
CSA	CARPARK SUPPLY AIR	HYD	HYDRAULIC RISER
ER	ELECTRICAL RISER	MR	MECHANICAL RISER
FE	FIRE EXTINGUISHER	OA	OUTSIDE AIR
FIP	FIRE INDICATOR PANEL	SC	SPRINKLER CONTROL

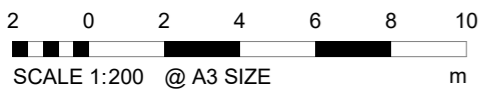

ISSUE A
Date of Issue | 31.01.2024

DATE	DESCRIPTION	BY	CHK	REV
31.01.2024	FOR DA SUBMISSION	VP	CLIENT & CST	A

DISCLAIMER
In accepting and utilising this document the recipient agrees that Plus Architecture Pty. Ltd. ACN 091 690 336, retain all common law, statutory law and other rights including copyright and intellectual property rights. The recipient agrees not to use this document for any purpose other than its intended use; to waive all claims against Plus Architecture resulting from unauthorised changes; or to reuse the document on other projects without the prior written consent of Plus Architecture. Under no circumstances shall transfer of this document be deemed a sale. Plus Architecture makes no warranties of fitness for any purpose. The Builder/Contractor shall verify job dimensions prior to any work commencing. Figured dimensions shall take precedence over scaled work.



NOMINATED ARCHITECTS NSW - Amit Julka 10002; Rido Pin 11286
 Level 4, 222 Clarence Street
 Sydney NSW 2000
 sydney@plusarchitecture.com.au
 www.plusarchitecture.com.au
 TELEPHONE +61 2 8823 7000
 Plus Architecture Sydney Pty Ltd
 ACN 618393338

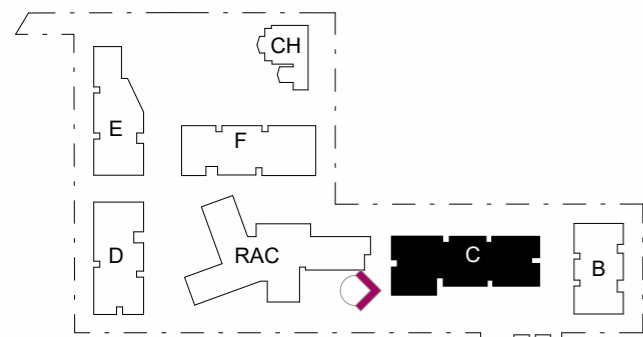

2 0 2 4 6 8 10
SCALE 1:200 @ A3 SIZE m

ISSUE A
Date of Issue | 16.02.2024

70303 | UNITING CARE | 24A KINGSCLIFF STREET, KINGSCLIFF, NSW 2487

DATE	DESCRIPTION	BY	CHK	REV
16.02.2024	FOR DA SUBMISSION	VP	CLIENT & CST	A

DISCLAIMER
In accepting and utilising this document the recipient agrees that Plus Architecture Pty. Ltd. ACN 091 690 336, retain all common law, statutory law and other rights including copyright and intellectual property rights. The recipient agrees not to use this document for any purpose other than its intended use; to waive all claims against Plus Architecture resulting from unauthorised changes; or to reuse the document on other projects without the prior written consent of Plus Architecture. Under no circumstances shall transfer of this document be deemed a sale. Plus Architecture makes no warranties of fitness for any purpose. The Builder/Contractor shall verify job dimensions prior to any work commencing. Figured dimensions shall take precedence over scaled work.



EXTERNAL FINISHES LEGEND

- BR1 BRICK TYPE 1
- BR2 BRICK TYPE 2
- BR3 BRICK TYPE 3
- BR4 BRICK TYPE 4
- GL1 GLAZING
- GL2 FRITTED GLAZING
- M1 METAL FINISH - CHARCOAL
- M2 METAL FINISH - BRONZE
- M3 METAL CLADDING - CHARCOAL
- M4 METAL CLADDING - GREY
- M5 METAL CLADDING - BRONZE
- P1 PAINT FINISH - DARK CHARCOAL
- P2 PAINT FINISH - GREY
- P3 PAINT FINISH - OFF WHITE
- P4 PAINT FINISH - TO MATCH M2
- P5 PAINT FINISH - OFF WHITE
- ST1 VERTICAL SCORING PRE-FINISHED FC CLADDING

NOMINATED ARCHITECTS NSW - Amit Julka 10002; Rido Pin 11286
Level 4, 222 Clarence Street TELEPHONE +61 2 8823 7000
Sydney NSW 2000
sydney@plusarchitecture.com.au Plus Architecture Sydney Pty Ltd
www.plusarchitecture.com.au ACN 618393338

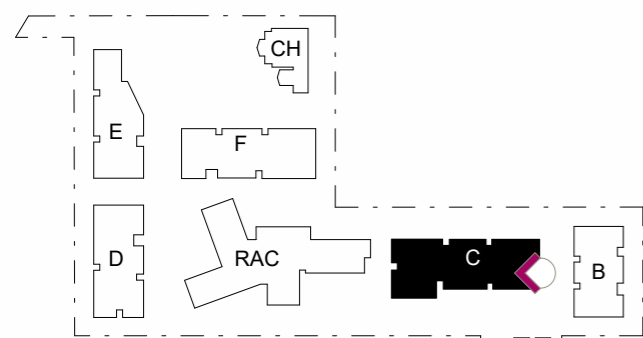

2 0 2 4 6 8 10
SCALE 1:200 @ A3 SIZE m

ISSUE A
Date of Issue | 16.02.2024

70303 | UNITING CARE | 24A KINGSCLIFF STREET, KINGSCLIFF, NSW 2487

DATE	DESCRIPTION	BY	CHK	REV
16.02.2024	FOR DA SUBMISSION	VP	CLIENT & CST	A

DISCLAIMER
In accepting and utilising this document the recipient agrees that Plus Architecture Pty. Ltd. ACN 091 690 336, retain all common law, statutory law and other rights including copyright and intellectual property rights. The recipient agrees not to use this document for any purpose other than its intended use; to waive all claims against Plus Architecture resulting from unauthorised changes; or to reuse the document on other projects without the prior written consent of Plus Architecture. Under no circumstances shall transfer of this document be deemed a sale. Plus Architecture makes no warranties of fitness for any purpose. The Builder/Contractor shall verify job dimensions prior to any work commencing. Figured dimensions shall take precedence over scaled work.



EXTERNAL FINISHES LEGEND

- BR1 BRICK TYPE 1
- BR2 BRICK TYPE 2
- BR3 BRICK TYPE 3
- BR4 BRICK TYPE 4
- GL1 GLAZING
- GL2 FRITTED GLAZING
- M1 METAL FINISH - CHARCOAL
- M2 METAL FINISH - BRONZE
- M3 METAL CLADDING - CHARCOAL
- M4 METAL CLADDING - GREY
- M5 METAL CLADDING - BRONZE
- P1 PAINT FINISH - DARK CHARCOAL
- P2 PAINT FINISH - GREY
- P3 PAINT FINISH - OFF WHITE
- P4 PAINT FINISH - TO MATCH M2
- P5 PAINT FINISH - OFF WHITE
- ST1 VERTICAL SCORING PRE-FINISHED FC CLADDING

NOMINATED ARCHITECTS NSW - Amit Julka 10002; Rido Pin 11286
Level 4, 222 Clarence Street TELEPHONE +61 2 8823 7000
Sydney NSW 2000 Plus Architecture Sydney Pty Ltd
sydney@plusarchitecture.com.au www.plusarchitecture.com.au ACN 618393338

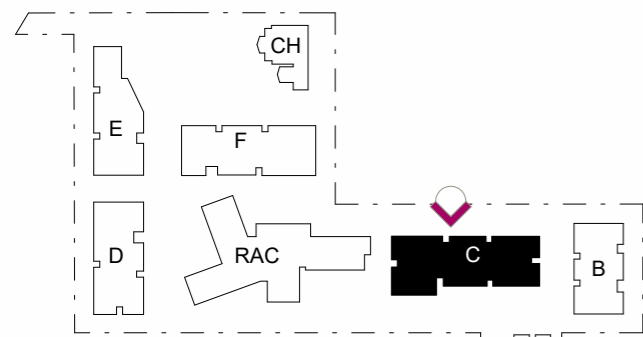

SCALE 1:200 @ A3 SIZE

ISSUE A
Date of Issue | 16.02.2024

70303 | UNITING CARE | 24A KINGSCLIFF STREET, KINGSCLIFF, NSW 2487

DATE	DESCRIPTION	BY	CHK	REV
16.02.2024	FOR DA SUBMISSION	VP	CLIENT & CST	A

DISCLAIMER
In accepting and utilising this document the recipient agrees that Plus Architecture Pty. Ltd. ACN 091 690 336, retain all common law, statutory law and other rights including copyright and intellectual property rights. The recipient agrees not to use this document for any purpose other than its intended use; to waive all claims against Plus Architecture resulting from unauthorised changes; or to reuse the document on other projects without the prior written consent of Plus Architecture. Under no circumstances shall transfer of this document be deemed a sale. Plus Architecture makes no warranties of fitness for any purpose. The Builder/Contractor shall verify job dimensions prior to any work commencing. Figured dimensions shall take precedence over scaled work.



EXTERNAL FINISHES LEGEND

- BR1 BRICK TYPE 1
- BR2 BRICK TYPE 2
- BR3 BRICK TYPE 3
- BR4 BRICK TYPE 4
- GL1 GLAZING
- GL2 FRITTED GLAZING
- M1 METAL FINISH - CHARCOAL
- M2 METAL FINISH - BRONZE
- M3 METAL CLADDING - CHARCOAL
- M4 METAL CLADDING - GREY
- M5 METAL CLADDING - BRONZE
- P1 PAINT FINISH - DARK CHARCOAL
- P2 PAINT FINISH - GREY
- P3 PAINT FINISH - OFF WHITE
- P4 PAINT FINISH - TO MATCH M2
- P5 PAINT FINISH - OFF WHITE
- ST1 VERTICAL SCORING PRE-FINISHED FC CLADDING

NOMINATED ARCHITECTS NSW - Amit Julka 10002; Rido Pin 11286
 Level 4, 222 Clarence Street TELEPHONE +61 2 8823 7000
 Sydney NSW 2000 Plus Architecture Sydney Pty Ltd
 sydney@plusarchitecture.com.au www.plusarchitecture.com.au ACN 618393338

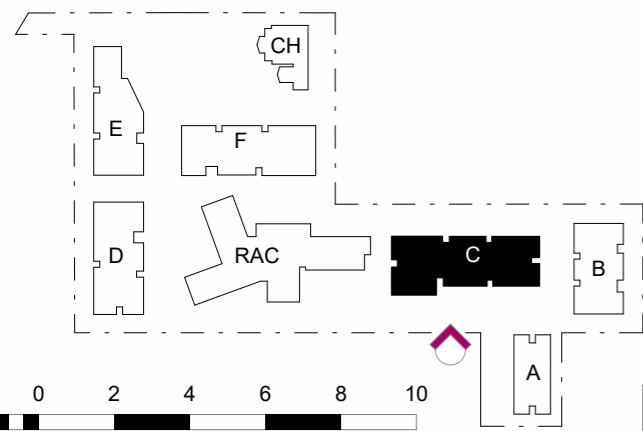

SCALE 1:200 @ A3 SIZE

ISSUE A
Date of Issue | 16.02.2024

70303 | UNITING CARE | 24A KINGSCLIFF STREET, KINGSCLIFF, NSW 2487

DATE	DESCRIPTION	BY	CHK	REV
16.02.2024	FOR DA SUBMISSION	VP	CLIENT & CST	A

DISCLAIMER
In accepting and utilising this document the recipient agrees that Plus Architecture Pty. Ltd. ACN 091 690 336, retain all common law, statutory law and other rights including copyright and intellectual property rights. The recipient agrees not to use this document for any purpose other than its intended use; to waive all claims against Plus Architecture resulting from unauthorised changes; or to reuse the document on other projects without the prior written consent of Plus Architecture. Under no circumstances shall transfer of this document be deemed a sale. Plus Architecture makes no warranties of fitness for any purpose. The Builder/Contractor shall verify job dimensions prior to any work commencing. Figured dimensions shall take precedence over scaled work.

EXTERNAL FINISHES LEGEND

- BR1 BRICK TYPE 1
- BR2 BRICK TYPE 2
- BR3 BRICK TYPE 3
- BR4 BRICK TYPE 4
- GL1 GLAZING
- GL2 FRITTED GLAZING
- M1 METAL FINISH - CHARCOAL
- M2 METAL FINISH - BRONZE
- M3 METAL CLADDING - CHARCOAL
- M4 METAL CLADDING - GREY
- M5 METAL CLADDING - BRONZE
- P1 PAINT FINISH - DARK CHARCOAL
- P2 PAINT FINISH - GREY
- P3 PAINT FINISH - OFF WHITE
- P4 PAINT FINISH - TO MATCH M2
- P5 PAINT FINISH - OFF WHITE
- ST1 VERTICAL SCORING PRE-FINISHED FC CLADDING



NOMINATED ARCHITECTS NSW - Amit Julka 10002; Rido Pin 11286
 Level 4, 222 Clarence Street TELEPHONE +61 2 8823 7000
 Sydney NSW 2000 Plus Architecture Sydney Pty Ltd
 www.plusarchitecture.com.au sydney@plusarchitecture.com.au
 www.plusarchitecture.com.au ACN 618393338

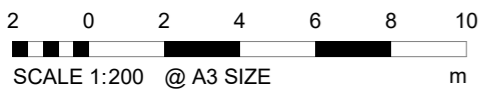
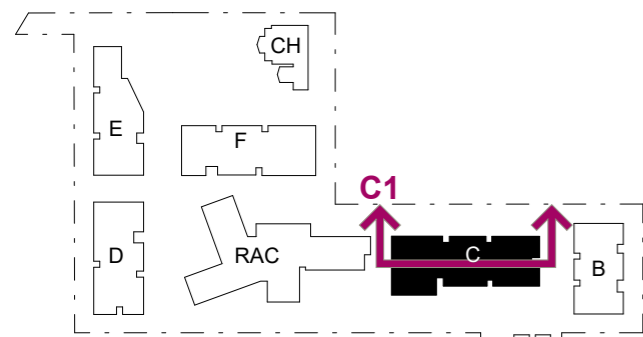
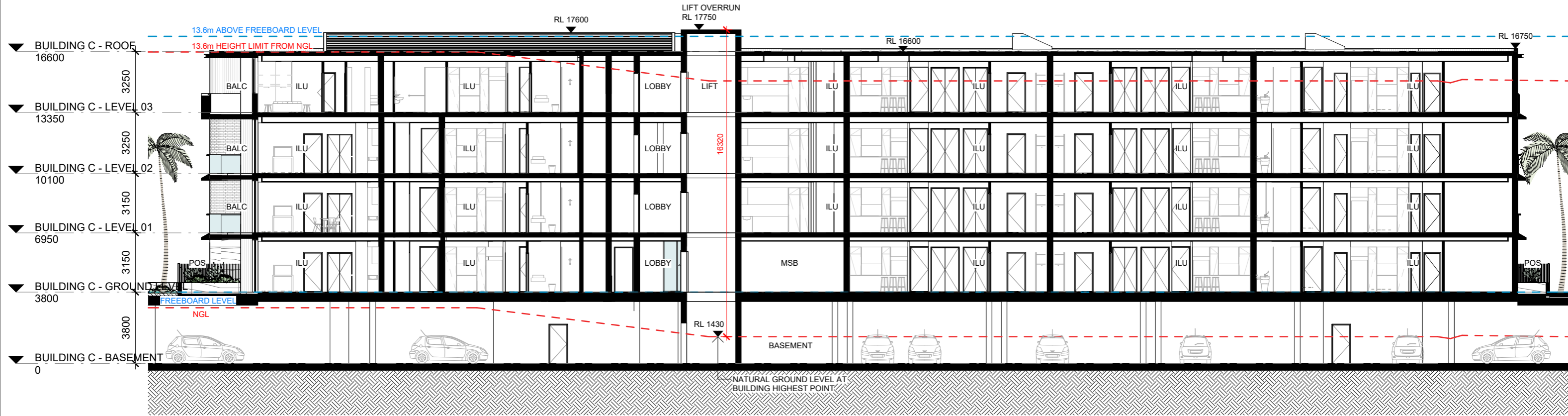

ISSUE A
Date of Issue | 16.02.2024

70303 | UNITING CARE | 24A KINGSCLIFF STREET, KINGSCLIFF, NSW 2487

DATE	DESCRIPTION	BY	CHK	REV
16.02.2024	FOR DA SUBMISSION	VP	CLIENT & CST	A

DISCLAIMER
In accepting and utilising this document the recipient agrees that Plus Architecture Pty. Ltd. ACN 091 690 336, retain all common law, statutory law and other rights including copyright and intellectual property rights. The recipient agrees not to use this document for any purpose other than its intended use; to waive all claims against Plus Architecture resulting from unauthorised changes; or to reuse the document on other projects without the prior written consent of Plus Architecture. Under no circumstances shall transfer of this document be deemed a sale. Plus Architecture makes no warranties of fitness for any purpose. The Builder/Contractor shall verify job dimensions prior to any work commencing. Figured dimensions shall take precedence over scaled work.



NOMINATED ARCHITECTS NSW - Amit Julka 10002; Rido Pin 11286
Level 4, 222 Clarence Street
Sydney NSW 2000
sydney@plusarchitecture.com.au
www.plusarchitecture.com.au
TELEPHONE +61 2 8823 7000
Plus Architecture Sydney Pty Ltd
ACN 618393338

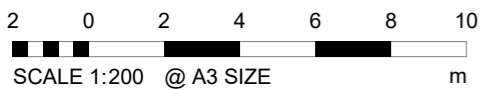
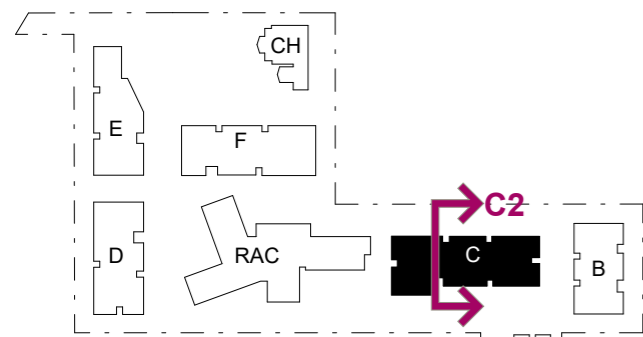
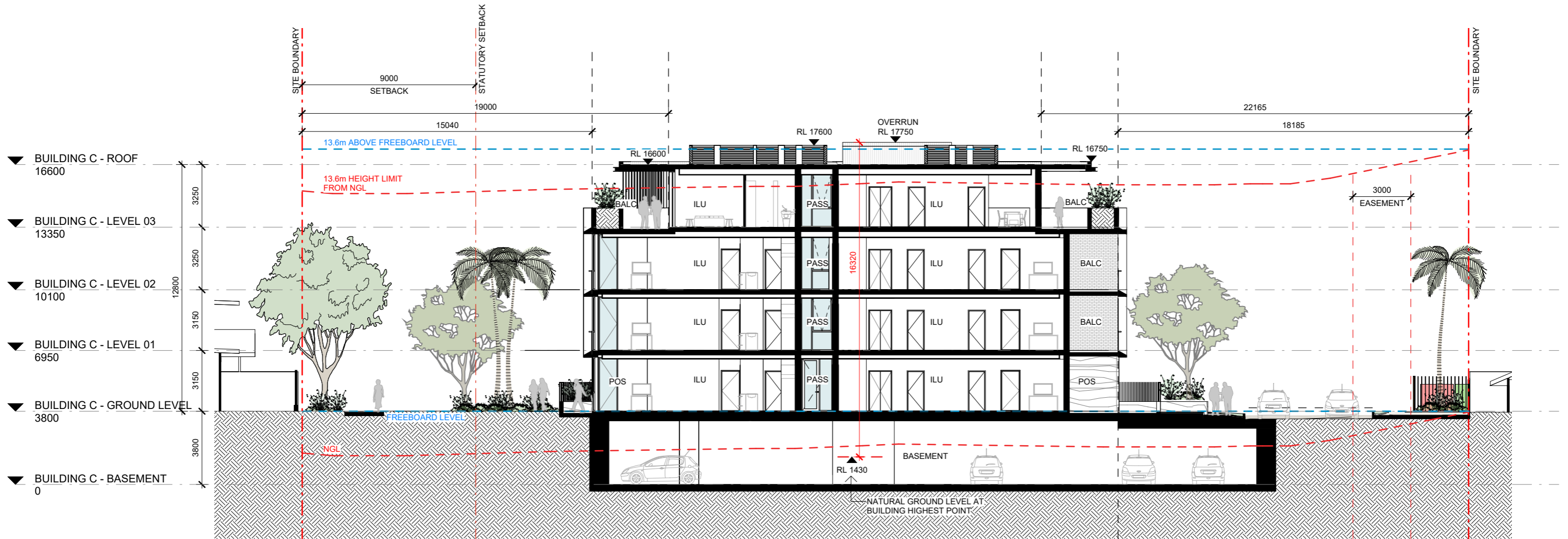

ISSUE A
Date of Issue | 16.02.2024

70303 | UNITING CARE | 24A KINGSCLIFF STREET, KINGSCLIFF, NSW 2487

DATE	DESCRIPTION	BY	CHK	REV
16.02.2024	FOR DA SUBMISSION	VP	CLIENT & CST	A

DISCLAIMER
In accepting and utilising this document the recipient agrees that Plus Architecture Pty. Ltd. ACN 091 690 336, retain all common law, statutory law and other rights including copyright and intellectual property rights. The recipient agrees not to use this document for any purpose other than its intended use; to waive all claims against Plus Architecture resulting from unauthorised changes; or to reuse the document on other projects without the prior written consent of Plus Architecture. Under no circumstances shall transfer of this document be deemed a sale. Plus Architecture makes no warranties of fitness for any purpose. The Builder/Contractor shall verify job dimensions prior to any work commencing. Figured dimensions shall take precedence over scaled work.



NOMINATED ARCHITECTS NSW - Amit Julka 10002; Rido Pin 11286
Level 4, 222 Clarence Street
Sydney NSW 2000
sydney@plusarchitecture.com.au
www.plusarchitecture.com.au
TELEPHONE +61 2 8823 7000
Plus Architecture Sydney Pty Ltd
ACN 618393338



AREA PLAN (GFA)
GROUND FLOOR

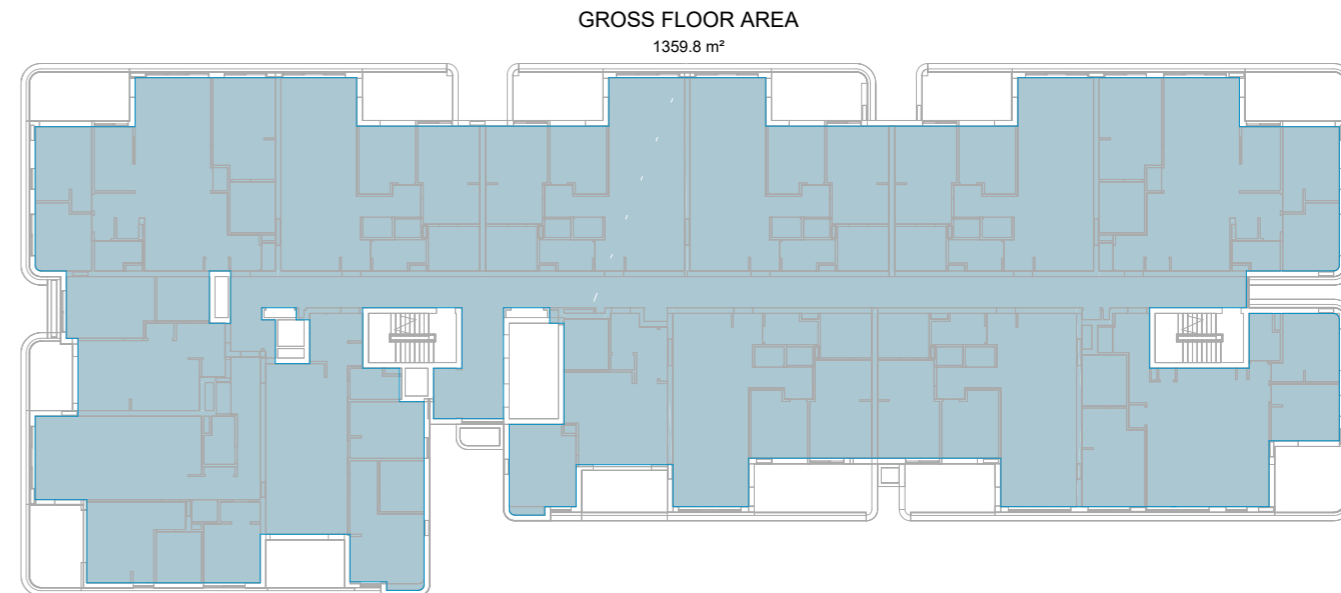

AREA PLAN (GFA)
LEVEL 01

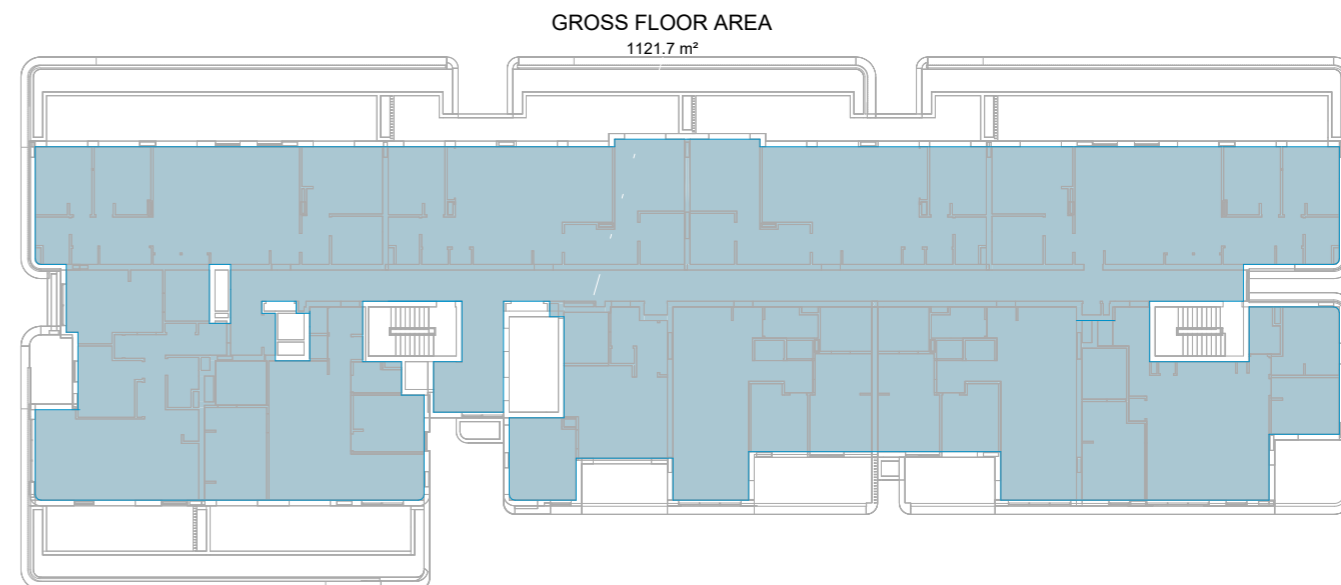

AREA PLAN (GFA)
LEVEL 03

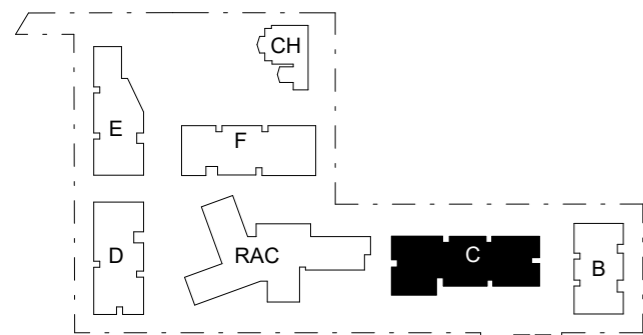

GROSS FLOOR AREA - GROUND LEVEL	
BUILDING C - GROUND LEVEL	1299.6 m ²
BUILDING C - LEVEL 01	1359.8 m ²
BUILDING C - LEVEL 02	1359.8 m ²
BUILDING C - LEVEL 03	1121.7 m ²
TOTAL GROSS FLOOR AREA	5140.9 m²

DATE	DESCRIPTION	BY	CHK	REV
31.01.2024	FOR DA SUBMISSION	VP	CLIENT & CST	A

4 0 4 8 12 16 20
SCALE 1:400 @ A3 SIZE m

ISSUE A
Date of Issue | 31.01.2024

70303 | UNITING CARE | 24A KINGSCLIFF STREET, KINGSCLIFF, NSW 2487

LEGENDS

GFA

Uniting

plus
architecture

NOMINATED ARCHITECTS NSW - Amit Julka 10002; Rido Pin 11286
Level 4, 222 Clarence Street TELEPHONE +61 2 8823 7000
Sydney NSW 2000
sydney@plusarchitecture.com.au Plus Architecture Sydney Pty Ltd
www.plusarchitecture.com.au ACN 618393338

DISCLAIMER
In accepting and utilising this document the recipient agrees that Plus Architecture Pty. Ltd. ACN 091 690 336, retain all common law, statutory law and other rights including copyright and intellectual property rights. The recipient agrees not to use this document for any purpose other than its intended use; to waive all claims against Plus Architecture resulting from unauthorised changes; or to reuse the document on other projects without the prior written consent of Plus Architecture. Under no circumstances shall transfer of this document be deemed a sale. Plus Architecture makes no warranties of fitness for any purpose. The Builder/Contractor shall verify job dimensions prior to any work commencing. Figured dimensions shall take precedence over scaled work.

DRAWING TO BE READ IN CONJUNCTION WITH A0000 LEGEND, RELEVANT SCHEDULES AND PROJECT SPECIFICATION. REFER TO LANDSCAPE ARCHITECT'S DRAWINGS FOR LANDSCAPE AREA DETAILS

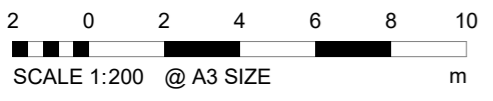

ISSUE A
Date of Issue | 31.01.2024

70303 | UNITING CARE | 24A KINGSCLIFF STREET, KINGSCLIFF, NSW 2487

DATE	DESCRIPTION	BY	CHK	REV
31.01.2024	FOR DA SUBMISSION	VP	CLIENT & CST	A

DISCLAIMER
In accepting and utilising this document the recipient agrees that Plus Architecture Pty. Ltd. ACN 091 690 336, retain all common law, statutory law and other rights including copyright and intellectual property rights. The recipient agrees not to use this document for any purpose other than its intended use; to waive all claims against Plus Architecture resulting from unauthorised changes; or to reuse the document on other projects without the prior written consent of Plus Architecture. Under no circumstances shall transfer of this document be deemed a sale. Plus Architecture makes no warranties of fitness for any purpose. The Builder/Contractor shall verify job dimensions prior to any work commencing. Figured dimensions shall take precedence over scaled work.



NOMINATED ARCHITECTS NSW - Amit Julka 10002; Rido Pin 11286
Level 4, 222 Clarence Street
Sydney NSW 2000
sydney@plusarchitecture.com.au
www.plusarchitecture.com.au
TELEPHONE +61 2 8823 7000
Plus Architecture Sydney Pty Ltd
ACN 618393338

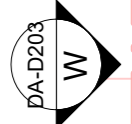

D.204
3 BED
106.7 m²
BALCONY
12.8 m²

D.205
2 BED
90.7 m²
BALCONY
12.2 m²

D.206
2 BED
90.7 m²
BALCONY
12.2 m²

D.207
2 BED
90.7 m²
BALCONY
15.9 m²

D.208
3 BED
108.5 m²
BALCONY
10.9 m²

D.203
2 BED
99.4 m²
BALCONY
12.7 m²

D.202
2 BED
90.8 m²
BALCONY
14.1 m²

D.201
1 BED
57.1 m²
BALCONY
9.6 m²

D.209
2 BED + STUDY
103.0 m²
BALCONY
12.2 m²

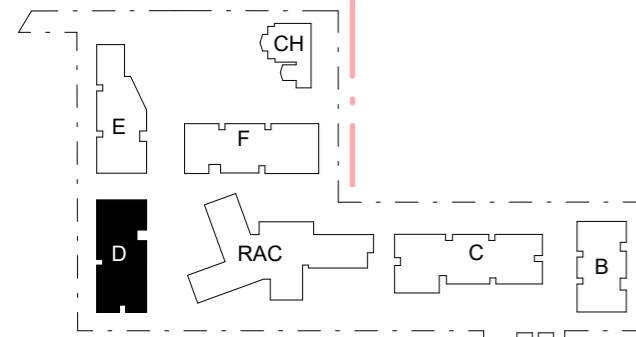

LEGEND

CER	CARPARK EXHAUST RISER	GE	CLN ROOM EXHAUST RISER
CSA	CARPARK SUPPLY AIR	HYD	HYDRAULIC RISER
ER	ELECTRICAL RISER	MR	MECHANICAL RISER
FE	FIRE EXTINGUISHER	OA	OUTSIDE AIR
FIP	FIRE INDICATOR PANEL	SC	SPRINKLER CONTROL

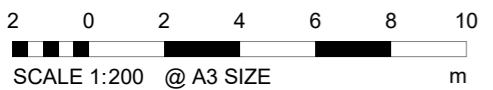

ISSUE A
Date of Issue | 31.01.2024

70303 | UNITING CARE | 24A KINGSCLIFF STREET, KINGSCLIFF, NSW 2487

DATE	DESCRIPTION	BY	CHK	REV
31.01.2024	FOR DA SUBMISSION	VP	CLIENT & CST	A

DISCLAIMER
In accepting and utilising this document the recipient agrees that Plus Architecture Pty. Ltd. ACN 091 690 336, retain all common law, statutory law and other rights including copyright and intellectual property rights. The recipient agrees not to use this document for any purpose other than its intended use; to waive all claims against Plus Architecture resulting from unauthorised changes; or to reuse the document on other projects without the prior written consent of Plus Architecture. Under no circumstances shall transfer of this document be deemed a sale. Plus Architecture makes no warranties of fitness for any purpose. The Builder/Contractor shall verify job dimensions prior to any work commencing. Figured dimensions shall take precedence over scaled work.



NOMINATED ARCHITECTS NSW - Amit Julka 10002; Rido Pin 11286
Level 4, 222 Clarence Street
Sydney NSW 2000
sydney@plusarchitecture.com.au
www.plusarchitecture.com.au
TELEPHONE +61 2 8823 7000
Plus Architecture Sydney Pty Ltd
ACN 618393338



D.404
3 BED
109.2 m²
BALCONY
37.7 m²

D.405
2 BED
92.7 m²
BALCONY
21.9 m²

D.406
2 BED
92.1 m²
BALCONY
24.9 m²

D.407
3 BED + STUDY
121.0 m²
BALCONY
21.1 m²

D.403
2 BED
86.6 m²
BALCONY
26.0 m²

D.402
2 BED
90.8 m²
BALCONY
16.0 m²

D.401
1 BED
57.7 m²
BALCONY
9.6 m²

D.408
2 BED + STUDY
103.0 m²
BALCONY
14.1 m²

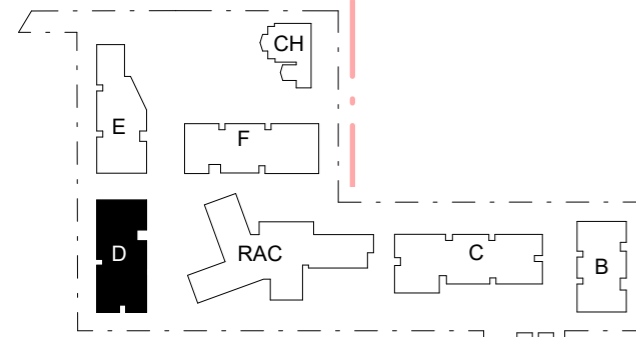

LEGEND

CER	CARPARK EXHAUST RISER	GE	CLN ROOM EXHAUST RISER
CSA	CARPARK SUPPLY AIR	HYD	HYDRAULIC RISER
ER	ELECTRICAL RISER	MR	MECHANICAL RISER
FE	FIRE EXTINGUISHER	OA	OUTSIDE AIR
FIP	FIRE INDICATOR PANEL	SC	SPRINKLER CONTROL

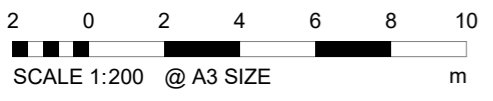

ISSUE A
Date of Issue | 31.01.2024

70303 | UNITING CARE | 24A KINGSCLIFF STREET, KINGSCLIFF, NSW 2487

DATE	DESCRIPTION	BY	CHK	REV
31.01.2024	FOR DA SUBMISSION	VP	CLIENT & CST	A

DISCLAIMER
In accepting and utilising this document the recipient agrees that Plus Architecture Pty. Ltd. ACN 091 690 336, retain all common law, statutory law and other rights including copyright and intellectual property rights. The recipient agrees not to use this document for any purpose other than its intended use; to waive all claims against Plus Architecture resulting from unauthorised changes; or to reuse the document on other projects without the prior written consent of Plus Architecture. Under no circumstances shall transfer of this document be deemed a sale. Plus Architecture makes no warranties of fitness for any purpose. The Builder/Contractor shall verify job dimensions prior to any work commencing. Figured dimensions shall take precedence over scaled work.



NOMINATED ARCHITECTS NSW - Amit Julka 10002; Rido Pin 11286
Level 4, 222 Clarence Street
Sydney NSW 2000
sydney@plusarchitecture.com.au
www.plusarchitecture.com.au

TELEPHONE +61 2 8823 7000
Plus Architecture Sydney Pty Ltd
ACN 618393338

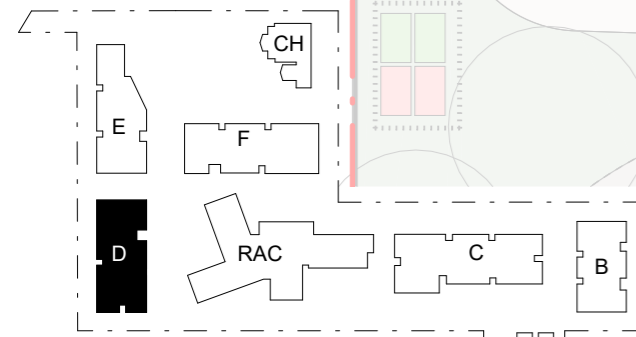
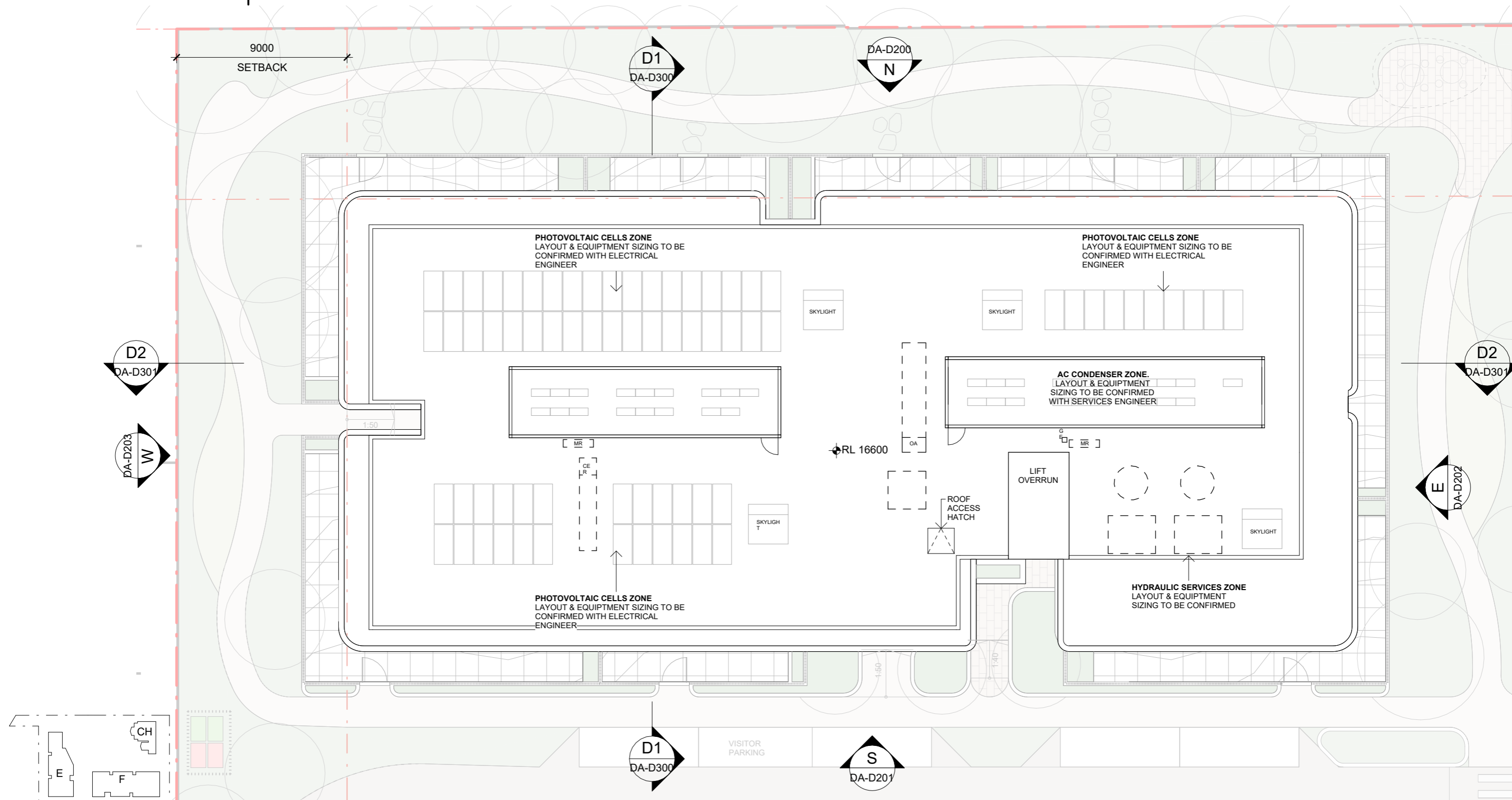

LEGEND

CER	CARPARK EXHAUST RISER	GE	CLN ROOM EXHAUST RISER
CSA	CARPARK SUPPLY AIR	HYD	HYDRAULIC RISER
ER	ELECTRICAL RISER	MR	MECHANICAL RISER
FE	FIRE EXTINGUISHER	OA	OUTSIDE AIR
FIP	FIRE INDICATOR PANEL	SC	SPRINKLER CONTROL

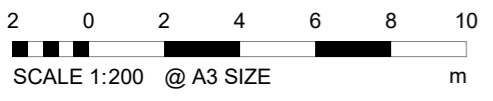

ISSUE A
Date of Issue | 31.01.2024

70303 | UNITING CARE | 24A KINGSCLIFF STREET, KINGSCLIFF, NSW 2487

DATE	DESCRIPTION	BY	CHK	REV
31.01.2024	FOR DA SUBMISSION	VP	CLIENT & CST	A

DISCLAIMER
In accepting and utilising this document the recipient agrees that Plus Architecture Pty. Ltd. ACN 091 690 336, retain all common law, statutory law and other rights including copyright and intellectual property rights. The recipient agrees not to use this document for any purpose other than its intended use; to waive all claims against Plus Architecture resulting from unauthorised changes; or to reuse the document on other projects without the prior written consent of Plus Architecture. Under no circumstances shall transfer of this document be deemed a sale. Plus Architecture makes no warranties of fitness for any purpose. The Builder/Contractor shall verify job dimensions prior to any work commencing. Figured dimensions shall take precedence over scaled work.



NOMINATED ARCHITECTS NSW - Amit Julka 10002; Rido Pin 11286
Level 4, 222 Clarence Street
Sydney NSW 2000
sydney@plusarchitecture.com.au
www.plusarchitecture.com.au
TELEPHONE +61 2 8823 7000
Plus Architecture Sydney Pty Ltd
ACN 618393338

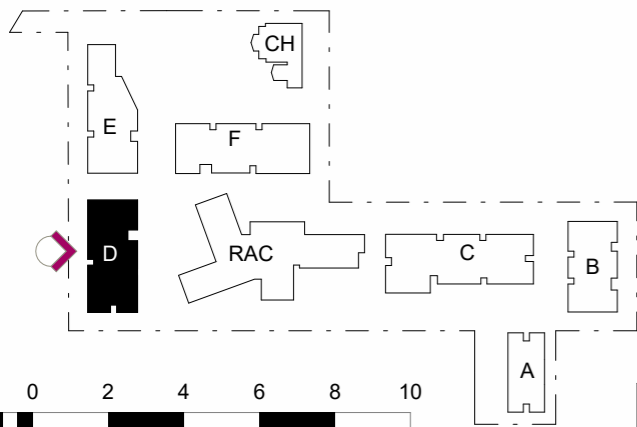

SCALE 1:200 @ A3 SIZE

ISSUE A
Date of Issue | 16.02.2024

70303 | UNITING CARE | 24A KINGSCLIFF STREET, KINGSCLIFF, NSW 2487

DATE	DESCRIPTION	BY	CHK	REV
16.02.2024	FOR DA SUBMISSION	VP	CLIENT & CST	A

DISCLAIMER
In accepting and utilising this document the recipient agrees that Plus Architecture Pty. Ltd. ACN 091 690 336, retain all common law, statutory law and other rights including copyright and intellectual property rights. The recipient agrees not to use this document for any purpose other than its intended use; to waive all claims against Plus Architecture resulting from unauthorised changes; or to reuse the document on other projects without the prior written consent of Plus Architecture. Under no circumstances shall transfer of this document be deemed a sale. Plus Architecture makes no warranties of fitness for any purpose. The Builder/Contractor shall verify job dimensions prior to any work commencing. Figured dimensions shall take precedence over scaled work.



EXTERNAL FINISHES LEGEND

- BR1 BRICK TYPE 1
- BR2 BRICK TYPE 2
- BR3 BRICK TYPE 3
- BR4 BRICK TYPE 4
- GL1 GLAZING
- GL2 FRITTED GLAZING
- M1 METAL FINISH - CHARCOAL
- M2 METAL FINISH - BRONZE
- M3 METAL CLADDING - CHARCOAL
- M4 METAL CLADDING - GREY
- M5 METAL CLADDING - BRONZE
- P1 PAINT FINISH - DARK CHARCOAL
- P2 PAINT FINISH - GREY
- P3 PAINT FINISH - OFF WHITE
- P4 PAINT FINISH - TO MATCH M2
- P5 PAINT FINISH - OFF WHITE
- ST1 PRE-FINISHED FC CLADDING

NOMINATED ARCHITECTS NSW - Amit Julka 10002; Rido Pin 11286

Level 4, 222 Clarence Street TELEPHONE +61 2 8823 7000
Sydney NSW 2000
sydney@plusarchitecture.com.au Plus Architecture Sydney Pty Ltd
www.plusarchitecture.com.au ACN 618393338

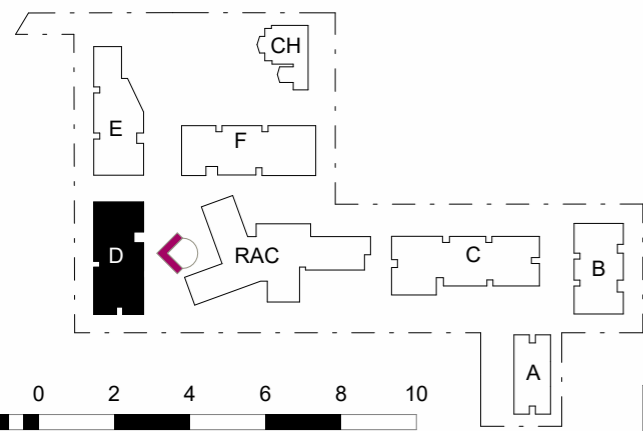

SCALE 1:200 @ A3 SIZE

ISSUE A
Date of Issue | 16.02.2024

70303 | UNITING CARE | 24A KINGSCLIFF STREET, KINGSCLIFF, NSW 2487

DATE	DESCRIPTION	BY	CHK	REV
16.02.2024	FOR DA SUBMISSION	VP	CLIENT & CST	A

DISCLAIMER
In accepting and utilising this document the recipient agrees that Plus Architecture Pty. Ltd. ACN 091 690 336, retain all common law, statutory law and other rights including copyright and intellectual property rights. The recipient agrees not to use this document for any purpose other than its intended use; to waive all claims against Plus Architecture resulting from unauthorised changes; or to reuse the document on other projects without the prior written consent of Plus Architecture. Under no circumstances shall transfer of this document be deemed a sale. Plus Architecture makes no warranties of fitness for any purpose. The Builder/Contractor shall verify job dimensions prior to any work commencing. Figured dimensions shall take precedence over scaled work.



EXTERNAL FINISHES LEGEND

- BR1 BRICK TYPE 1
- BR2 BRICK TYPE 2
- BR3 BRICK TYPE 3
- BR4 BRICK TYPE 4
- GL1 GLAZING
- GL2 FRITTED GLAZING
- M1 METAL FINISH - CHARCOAL
- M2 METAL FINISH - BRONZE
- M3 METAL CLADDING - CHARCOAL
- M4 METAL CLADDING - GREY
- M5 METAL CLADDING - BRONZE
- P1 PAINT FINISH - DARK CHARCOAL
- P2 PAINT FINISH - GREY
- P3 PAINT FINISH - OFF WHITE
- P4 PAINT FINISH - TO MATCH M2
- P5 PAINT FINISH - OFF WHITE
- ST1 VERTICAL SCORING
- ST1 PRE-FINISHED FC CLADDING

NOMINATED ARCHITECTS NSW - Amit Julka 10002; Rido Pin 11286
 Level 4, 222 Clarence Street TELEPHONE +61 2 8823 7000
 Sydney NSW 2000
 sydney@plusarchitecture.com.au Plus Architecture Sydney Pty Ltd
 www.plusarchitecture.com.au ACN 618393338

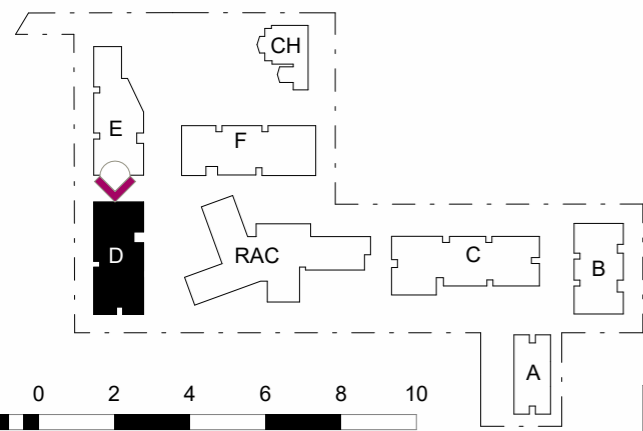

2 0 2 4 6 8 10
SCALE 1:200 @ A3 SIZE m

ISSUE A
Date of Issue | 16.02.2024

70303 | UNITING CARE | 24A KINGSCLIFF STREET, KINGSCLIFF, NSW 2487

DATE	DESCRIPTION	BY	CHK	REV
16.02.2024	FOR DA SUBMISSION	VP	CLIENT & CST	A

DISCLAIMER
In accepting and utilising this document the recipient agrees that Plus Architecture Pty. Ltd. ACN 091 690 336, retain all common law, statutory law and other rights including copyright and intellectual property rights. The recipient agrees not to use this document for any purpose other than its intended use; to waive all claims against Plus Architecture resulting from unauthorised changes; or to reuse the document on other projects without the prior written consent of Plus Architecture. Under no circumstances shall transfer of this document be deemed a sale. Plus Architecture makes no warranties of fitness for any purpose. The Builder/Contractor shall verify job dimensions prior to any work commencing. Figured dimensions shall take precedence over scaled work.



EXTERNAL FINISHES LEGEND

- BR1 BRICK TYPE 1
- BR2 BRICK TYPE 2
- BR3 BRICK TYPE 3
- BR4 BRICK TYPE 4
- GL1 GLAZING
- GL2 FRITTED GLAZING
- M1 METAL FINISH - CHARCOAL
- M2 METAL FINISH - BRONZE
- M3 METAL CLADDING - CHARCOAL
- M4 METAL CLADDING - GREY
- M5 METAL CLADDING - BRONZE
- P1 PAINT FINISH - DARK CHARCOAL
- P2 PAINT FINISH - GREY
- P3 PAINT FINISH - OFF WHITE
- P4 PAINT FINISH - TO MATCH M2
- P5 PAINT FINISH - OFF WHITE
- ST1 VERTICAL SCORING PRE-FINISHED FC CLADDING

NOMINATED ARCHITECTS NSW - Amit Julka 10002; Rido Pin 11286
Level 4, 222 Clarence Street TELEPHONE +61 2 8823 7000
Sydney NSW 2000
sydney@plusarchitecture.com.au Plus Architecture Sydney Pty Ltd
www.plusarchitecture.com.au ACN 618393338

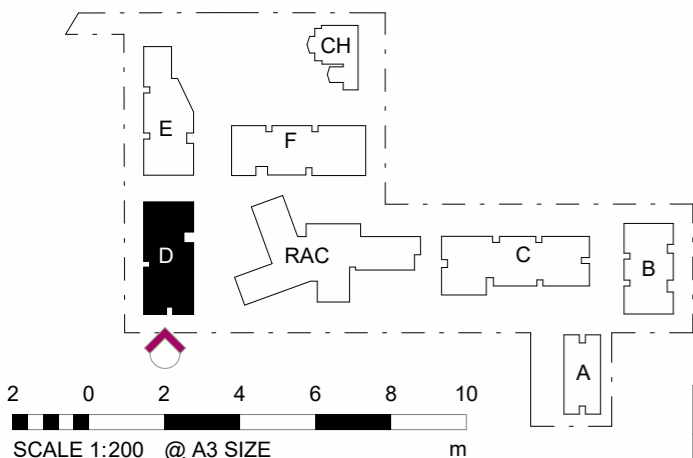

ISSUE A
Date of Issue | 16.02.2024

70303 | UNITING CARE | 24A KINGSCLIFF STREET, KINGSCLIFF, NSW 2487

DATE	DESCRIPTION	BY	CHK	REV
16.02.2024	FOR DA SUBMISSION	VP	CLIENT & CST	A

DISCLAIMER
In accepting and utilising this document the recipient agrees that Plus Architecture Pty. Ltd. ACN 091 690 336, retain all common law, statutory law and other rights including copyright and intellectual property rights. The recipient agrees not to use this document for any purpose other than its intended use; to waive all claims against Plus Architecture resulting from unauthorised changes; or to reuse the document on other projects without the prior written consent of Plus Architecture. Under no circumstances shall transfer of this document be deemed a sale. Plus Architecture makes no warranties of fitness for any purpose. The Builder/Contractor shall verify job dimensions prior to any work commencing. Figured dimensions shall take precedence over scaled work.



EXTERNAL FINISHES LEGEND

- BR1 BRICK TYPE 1
- BR2 BRICK TYPE 2
- BR3 BRICK TYPE 3
- BR4 BRICK TYPE 4
- GL1 GLAZING
- GL2 FRITTED GLAZING
- M1 METAL FINISH - CHARCOAL
- M2 METAL FINISH - BRONZE
- M3 METAL CLADDING - CHARCOAL
- M4 METAL CLADDING - GREY
- M5 METAL CLADDING - BRONZE
- P1 PAINT FINISH - DARK CHARCOAL
- P2 PAINT FINISH - GREY
- P3 PAINT FINISH - OFF WHITE
- P4 PAINT FINISH - TO MATCH M2
- P5 PAINT FINISH - OFF WHITE
- ST1 VERTICAL SCORING
- PRE-FINISHED FC CLADDING

NOMINATED ARCHITECTS NSW - Amit Julka 10002; Rido Pin 11286
Level 4, 222 Clarence Street TELEPHONE +61 2 8823 7000
Sydney NSW 2000
sydney@plusarchitecture.com.au Plus Architecture Sydney Pty Ltd
www.plusarchitecture.com.au ACN 618393338

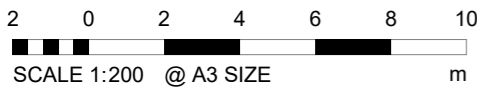
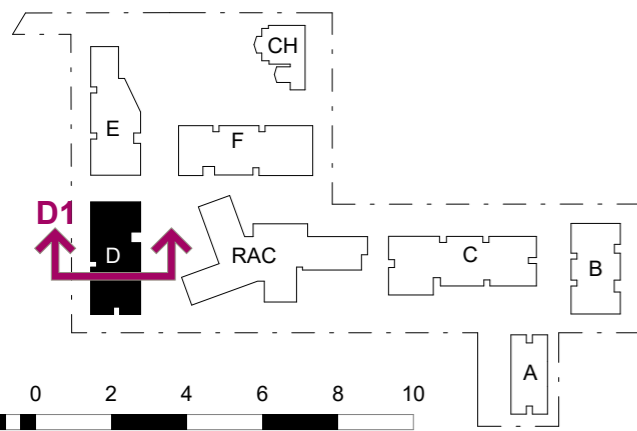
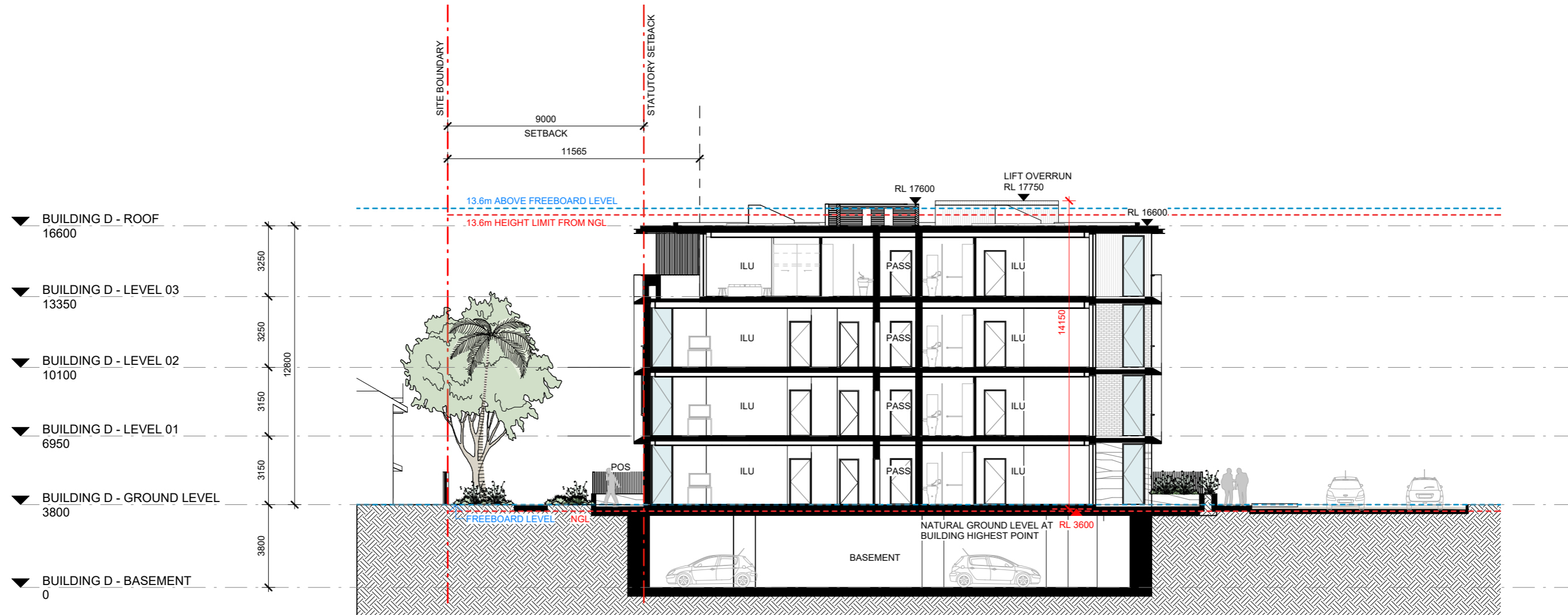

ISSUE A
Date of Issue | 16.02.2024

70303 | UNITING CARE | 24A KINGSCLIFF STREET, KINGSCLIFF, NSW 2487

DATE	DESCRIPTION	BY	CHK	REV
16.02.2024	FOR DA SUBMISSION	VP	CLIENT & CST	A

DISCLAIMER
In accepting and utilising this document the recipient agrees that Plus Architecture Pty. Ltd. ACN 091 690 336, retain all common law, statutory law and other rights including copyright and intellectual property rights. The recipient agrees not to use this document for any purpose other than its intended use; to waive all claims against Plus Architecture resulting from unauthorised changes; or to reuse the document on other projects without the prior written consent of Plus Architecture. Under no circumstances shall transfer of this document be deemed a sale. Plus Architecture makes no warranties of fitness for any purpose. The Builder/Contractor shall verify job dimensions prior to any work commencing. Figured dimensions shall take precedence over scaled work.



NOMINATED ARCHITECTS NSW - Amit Julka 10002; Rido Pin 11286
 Level 4, 222 Clarence Street TELEPHONE +61 2 8823 7000
 Sydney NSW 2000
 sydney@plusarchitecture.com.au Plus Architecture Sydney Pty Ltd
 www.plusarchitecture.com.au ACN 618393338

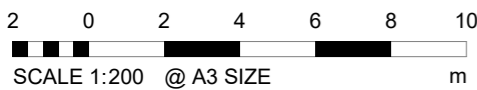
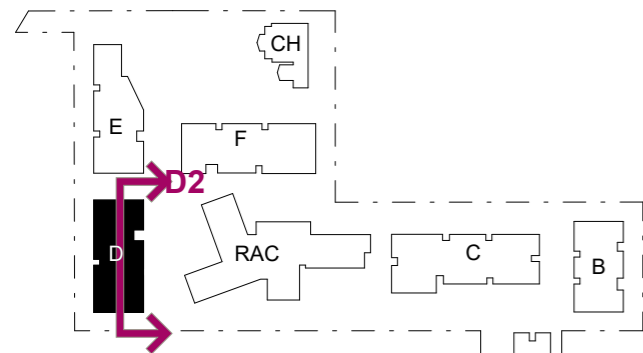
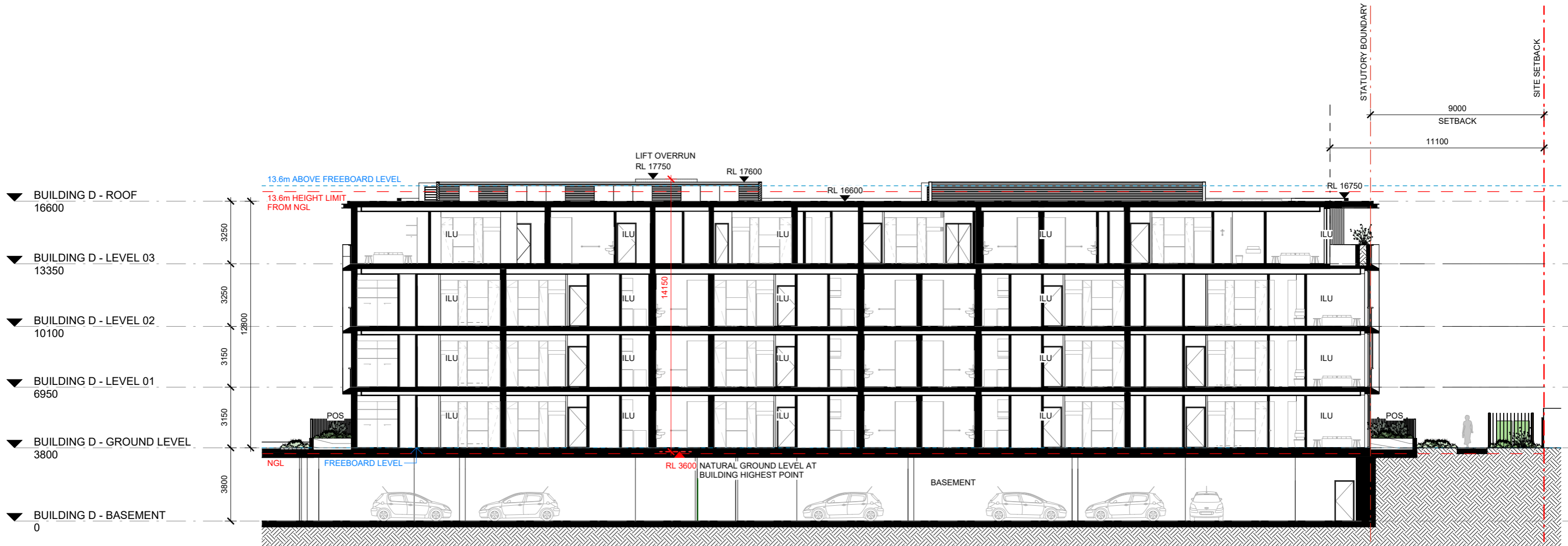

ISSUE A
Date of Issue | 16.02.2024

70303 | UNITING CARE | 24A KINGSCLIFF STREET, KINGSCLIFF, NSW 2487

DATE	DESCRIPTION	BY	CHK	REV
16.02.2024	FOR DA SUBMISSION	VP	CLIENT & CST	A

DISCLAIMER
In accepting and utilising this document the recipient agrees that Plus Architecture Pty. Ltd. ACN 091 690 336, retain all common law, statutory law and other rights including copyright and intellectual property rights. The recipient agrees not to use this document for any purpose other than its intended use; to waive all claims against Plus Architecture resulting from unauthorised changes; or to reuse the document on other projects without the prior written consent of Plus Architecture. Under no circumstances shall transfer of this document be deemed a sale. Plus Architecture makes no warranties of fitness for any purpose. The Builder/Contractor shall verify job dimensions prior to any work commencing. Figured dimensions shall take precedence over scaled work.



NOMINATED ARCHITECTS NSW - Amit Julka 10002; Rido Pin 11286
 Level 4, 222 Clarence Street
 Sydney NSW 2000
 sydney@plusarchitecture.com.au
 www.plusarchitecture.com.au
 TELEPHONE +61 2 8823 7000
 Plus Architecture Sydney Pty Ltd
 ACN 618393338

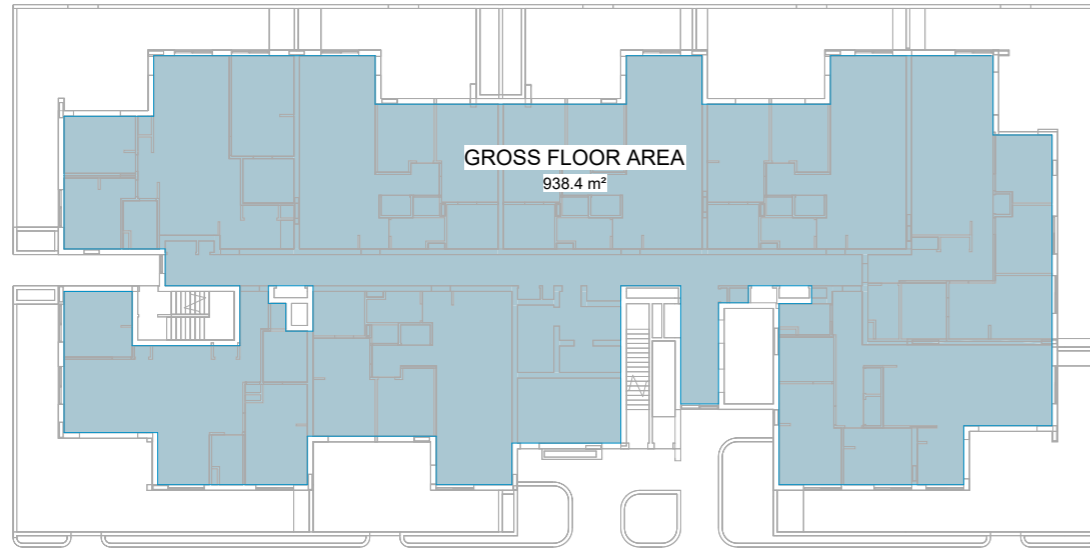

AREA PLAN (GFA)
GROUND LEVEL

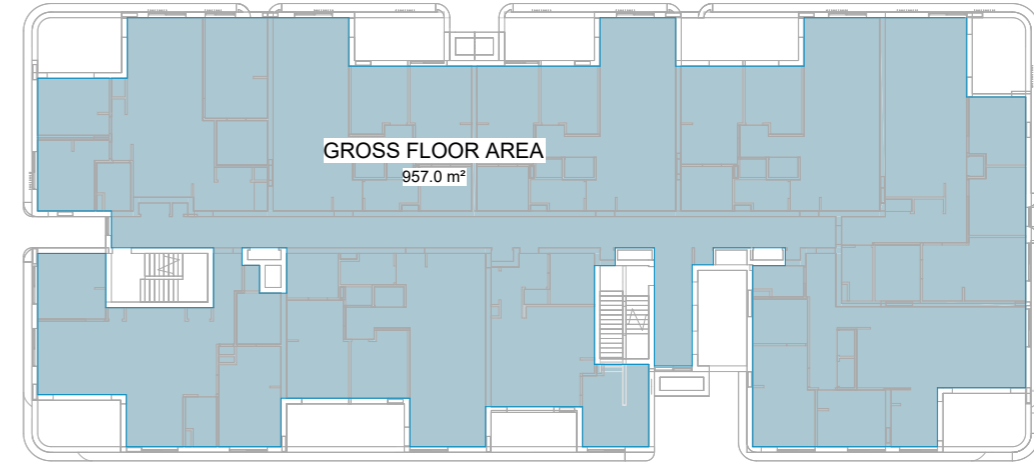

AREA PLAN (GFA)
LEVEL 01 - 02

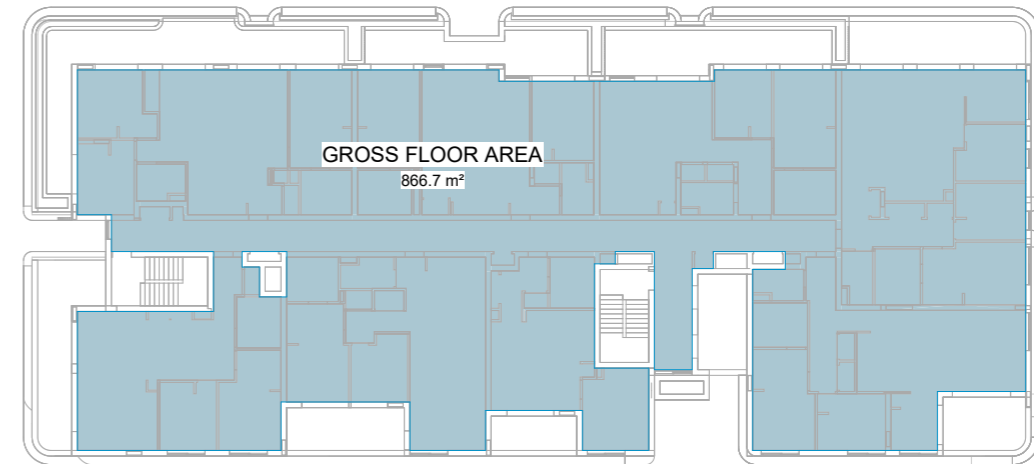

AREA PLAN (GFA)
LEVEL 03

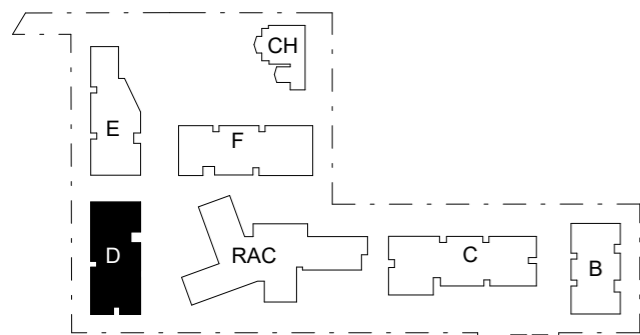

BUILDING D - GROUND LEVEL	938.4 m ²
BUILDING D - LEVEL 01	957.0 m ²
BUILDING D - LEVEL 02	957.0 m ²
BUILDING D - LEVEL 03	866.7 m ²
TOTAL GROSS FLOOR AREA	3719.0 m²

LEGENDS

GFA

4 0 4 8 12 16 20
SCALE 1:400 @ A3 SIZE m



ISSUE A
Date of Issue | 31.01.2024

70303 | UNITING CARE | 24A KINGSCLIFF STREET, KINGSCLIFF, NSW 2487

DATE	DESCRIPTION	BY	CHK	REV
31.01.2024	FOR DA SUBMISSION	VP	CLIENT & CST	A

DISCLAIMER
In accepting and utilising this document the recipient agrees that Plus Architecture Pty. Ltd. ACN 091 690 336, retain all common law, statutory law and other rights including copyright and intellectual property rights. The recipient agrees not to use this document for any purpose other than its intended use; to waive all claims against Plus Architecture resulting from unauthorised changes; or to reuse the document on other projects without the prior written consent of Plus Architecture. Under no circumstances shall transfer of this document be deemed a sale. Plus Architecture makes no warranties of fitness for any purpose. The Builder/Contractor shall verify job dimensions prior to any work commencing. Figured dimensions shall take precedence over scaled work.



NOMINATED ARCHITECTS NSW - Amit Julka 10002; Rido Pin 11286
Level 4, 222 Clarence Street
Sydney NSW 2000
sydney@plusarchitecture.com.au
www.plusarchitecture.com.au
TELEPHONE +61 2 8823 7000
Plus Architecture Sydney Pty Ltd
ACN 618393338

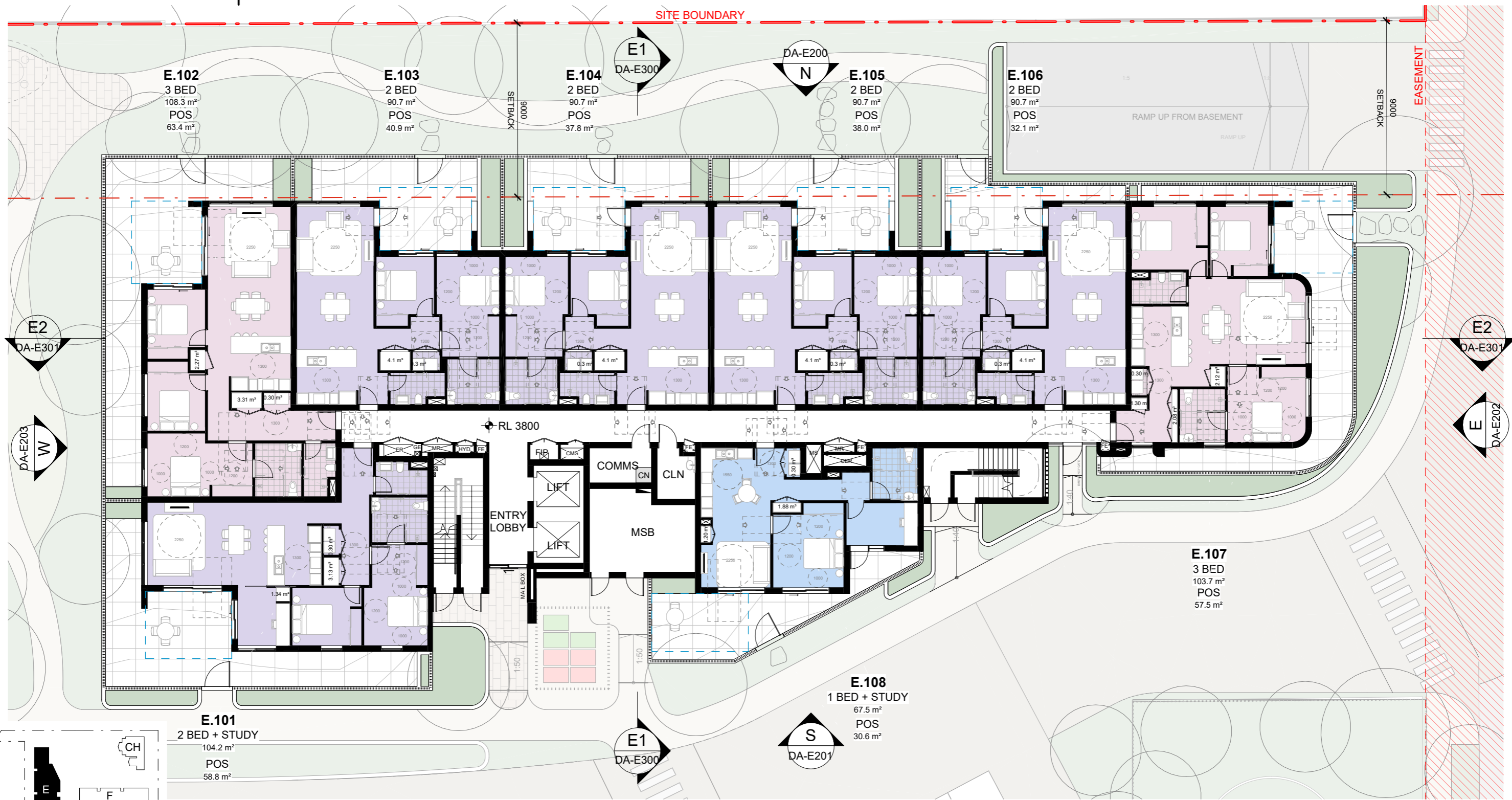

E.101
2 BED + STUDY
104.2 m²
POS
58.8 m²

E.108
1 BED + STUDY
67.5 m²
POS
30.6 m²

E.107
3 BED
103.7 m²
POS
57.5 m²

E.102
3 BED
108.3 m²
POS
63.4 m²

E.103
2 BED
90.7 m²
POS
40.9 m²

E.104
2 BED
90.7 m²
POS
37.8 m²

E.105
2 BED
90.7 m²
POS
38.0 m²

E.106
2 BED
90.7 m²
POS
32.1 m²

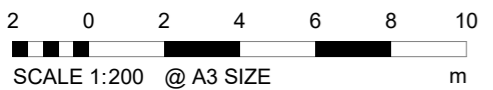

ISSUE A
Date of Issue | 31.01.2024

70303 | UNITING CARE | 24A KINGSCLIFF STREET, KINGSCLIFF, NSW 2487

LEGEND

CER	CARPARK EXHAUST RISER	GE	CLN ROOM EXHAUST RISER
CSA	CARPARK SUPPLY AIR	HYD	HYDRAULIC RISER
ER	ELECTRICAL RISER	MR	MECHANICAL RISER
FE	FIRE EXTINGUISHER	OA	OUTSIDE AIR
FIP	FIRE INDICATOR PANEL	SC	SPRINKLER CONTROL

DATE	DESCRIPTION	BY	CHK	REV
31.01.2024	FOR DA SUBMISSION	VP	CLIENT & CST	A

DISCLAIMER
In accepting and utilising this document the recipient agrees that Plus Architecture Pty. Ltd. ACN 091 690 336, retain all common law, statutory law and other rights including copyright and intellectual property rights. The recipient agrees not to use this document for any purpose other than its intended use; to waive all claims against Plus Architecture resulting from unauthorised changes; or to reuse the document on other projects without the prior written consent of Plus Architecture. Under no circumstances shall transfer of this document be deemed a sale. Plus Architecture makes no warranties of fitness for any purpose. The Builder/Contractor shall verify job dimensions prior to any work commencing. Figured dimensions shall take precedence over scaled work.



NOMINATED ARCHITECTS NSW - Amit Julka 10002; Rido Pin 11286
Level 4, 222 Clarence Street
Sydney NSW 2000
sydney@plusarchitecture.com.au
www.plusarchitecture.com.au
TELEPHONE +61 2 8823 7000
Plus Architecture Sydney Pty Ltd
ACN 618393338

SITE BOUNDARY



E2
DA-E301

DA-E203
W

E2
DA-E301

E
DA-E202

E1
DA-E300

DA-E200
N

E1
DA-E300

S
DA-E201

9000
SETBACK
EASEMENT

RL 6950

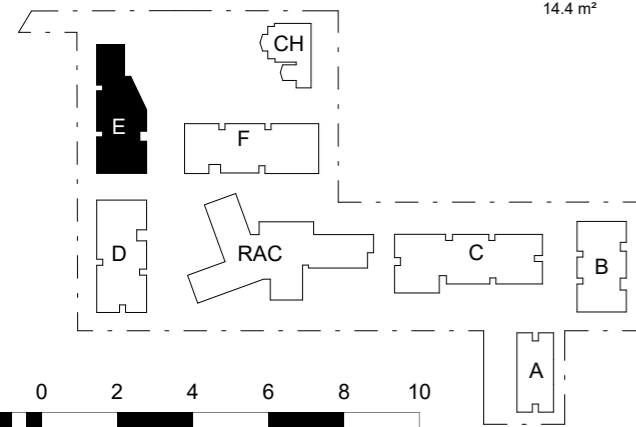

LEGEND

- CER CARPARK EXHAUST RISER
- CSA CARPARK SUPPLY AIR
- ER ELECTRICAL RISER
- FE FIRE EXTINGUISHER
- FIP FIRE INDICATOR PANEL
- GE CLN ROOM EXHAUST RISER
- HYD HYDRAULIC RISER
- MR MECHANICAL RISER
- OA OUTSIDE AIR
- SC SPRINKLER CONTROL

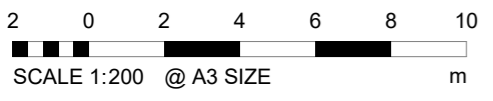

ISSUE A
Date of Issue | 31.01.2024

70303 | UNITING CARE | 24A KINGSCLIFF STREET, KINGSCLIFF, NSW 2487

DATE	DESCRIPTION	BY	CHK	REV
31.01.2024	FOR DA SUBMISSION	VP	CLIENT & CST	A

DISCLAIMER
In accepting and utilising this document the recipient agrees that Plus Architecture Pty. Ltd. ACN 091 690 336, retain all common law, statutory law and other rights including copyright and intellectual property rights. The recipient agrees not to use this document for any purpose other than its intended use; to waive all claims against Plus Architecture resulting from unauthorised changes; or to reuse the document on other projects without the prior written consent of Plus Architecture. Under no circumstances shall transfer of this document be deemed a sale. Plus Architecture makes no warranties of fitness for any purpose. The Builder/Contractor shall verify job dimensions prior to any work commencing. Figured dimensions shall take precedence over scaled work.



NOMINATED ARCHITECTS NSW - Amit Julka 10002; Rido Pin 11286
Level 4, 222 Clarence Street
Sydney NSW 2000
sydney@plusarchitecture.com.au
www.plusarchitecture.com.au
TELEPHONE +61 2 8823 7000
Plus Architecture Sydney Pty Ltd
ACN 618393338

SITE BOUNDARY

E1
DA-E300

DA-E200
N

E.402
3 BED
122.0 m²
BALCONY
25.9 m²

E.403
2 BED
92.6 m²
BALCONY
31.0 m²

E.404
2 BED
92.1 m²
BALCONY
36.4 m²

E.405
2 BED
92.6 m²
BALCONY
29.4 m²

E.406
3 BED + STUDY
120.6 m²
BALCONY
27.0 m²

9000
SETBACK
EASEMENT

E2
DA-E301

DA-E203
W

E2
DA-E301

E
DA-E202

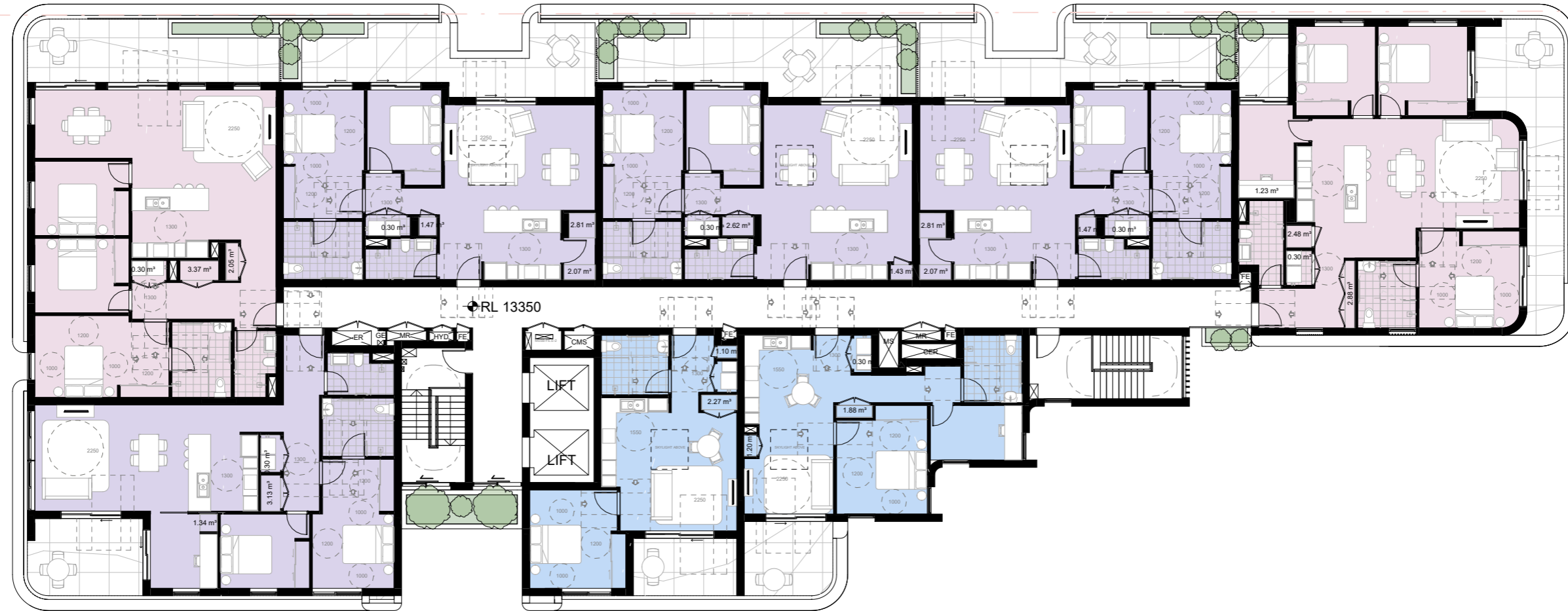

E.401
2 BED + STUDY
104.2 m²
BALCONY
18.3 m²

E.408
1 BED
56.6 m²
BALCONY
9.1 m²

E.407
1 BED + STUDY
67.5 m²
BALCONY
10.3 m²

E1
DA-E300

S
DA-E201

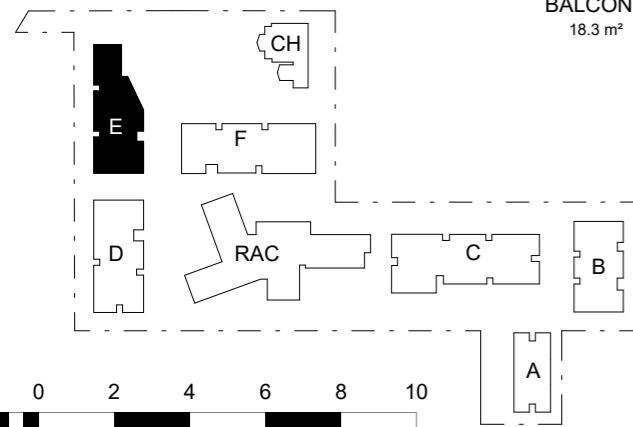

LEGEND

- | | | | |
|-----|-----------------------|-----|------------------------|
| CER | CARPARK EXHAUST RISER | GE | CLN ROOM EXHAUST RISER |
| CSA | CARPARK SUPPLY AIR | HYD | HYDRAULIC RISER |
| ER | ELECTRICAL RISER | MR | MECHANICAL RISER |
| FE | FIRE EXTINGUISHER | OA | OUTSIDE AIR |
| FIP | FIRE INDICATOR PANEL | SC | SPRINKLER CONTROL |

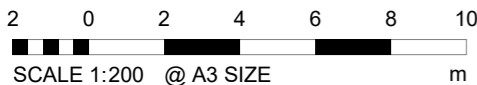

ISSUE A
Date of Issue | 31.01.2024

70303 | UNITING CARE | 24A KINGSCLIFF STREET, KINGSCLIFF, NSW 2487

DATE	DESCRIPTION	BY	CHK	REV
31.01.2024	FOR DA SUBMISSION	VP	CLIENT & CST	A

DISCLAIMER
In accepting and utilising this document the recipient agrees that Plus Architecture Pty. Ltd. ACN 091 690 336, retain all common law, statutory law and other rights including copyright and intellectual property rights. The recipient agrees not to use this document for any purpose other than its intended use; to waive all claims against Plus Architecture resulting from unauthorised changes; or to reuse the document on other projects without the prior written consent of Plus Architecture. Under no circumstances shall transfer of this document be deemed a sale. Plus Architecture makes no warranties of fitness for any purpose. The Builder/Contractor shall verify job dimensions prior to any work commencing. Figured dimensions shall take precedence over scaled work.



NOMINATED ARCHITECTS NSW - Amit Julka 10002; Rido Pin 11286
Level 4, 222 Clarence Street
Sydney NSW 2000
sydney@plusarchitecture.com.au
www.plusarchitecture.com.au
TELEPHONE +61 2 8823 7000
Plus Architecture Sydney Pty Ltd
ACN 618393338

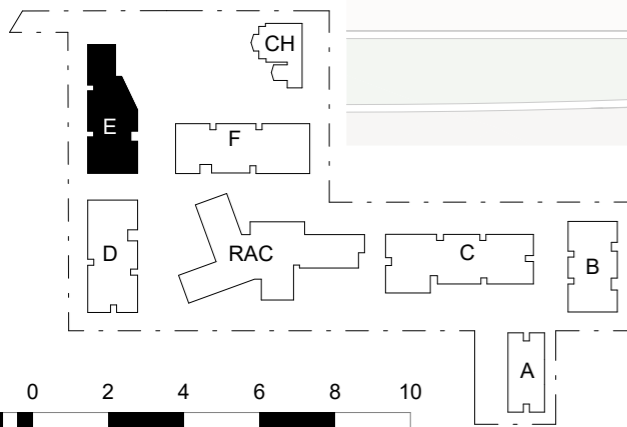
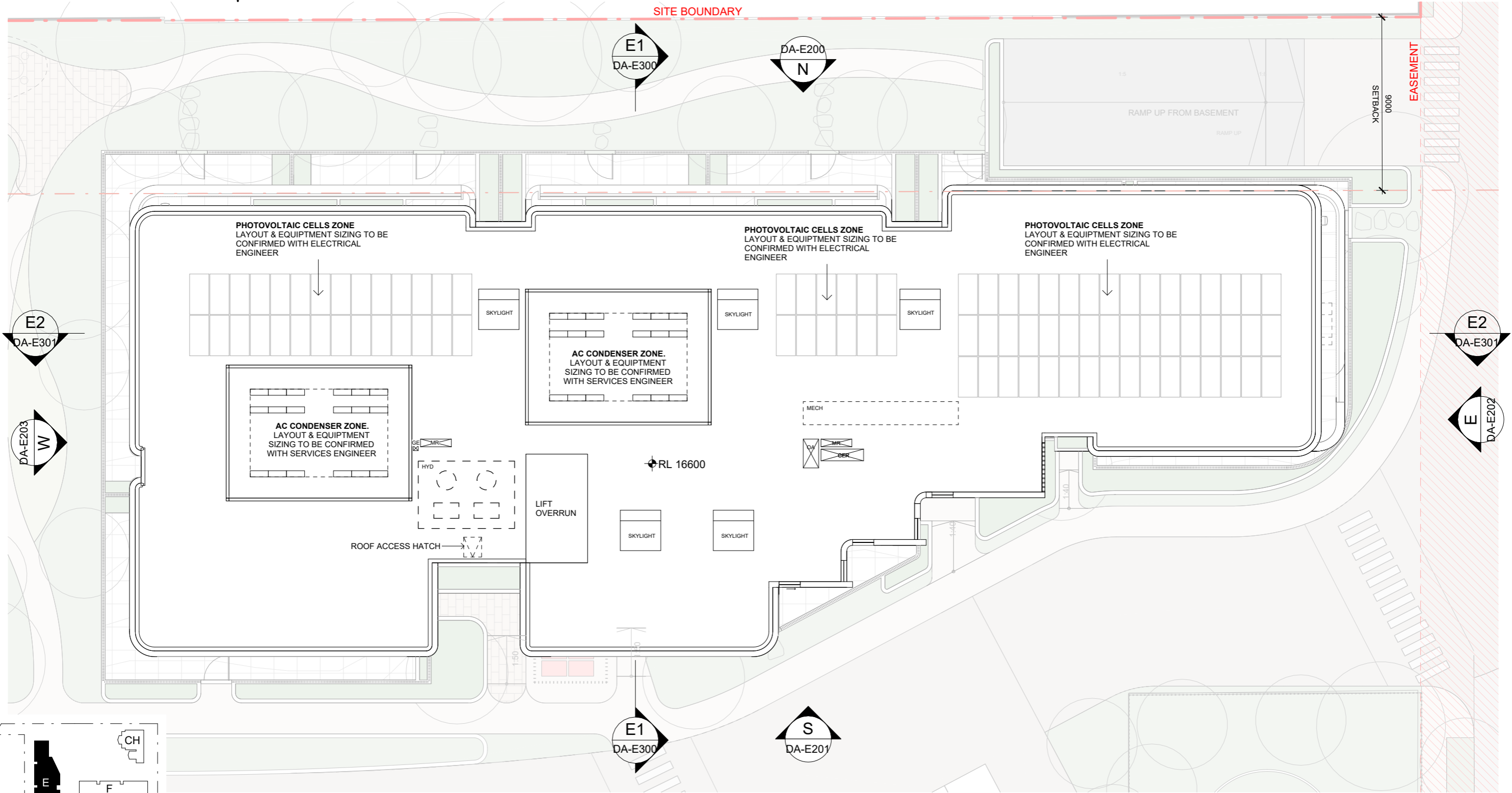

LEGEND

CER	CARPARK EXHAUST RISER	GE	CLN ROOM EXHAUST RISER
CSA	CARPARK SUPPLY AIR	HYD	HYDRAULIC RISER
ER	ELECTRICAL RISER	MR	MECHANICAL RISER
FE	FIRE EXTINGUISHER	OA	OUTSIDE AIR
FIP	FIRE INDICATOR PANEL	SC	SPRINKLER CONTROL

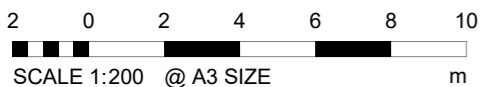

ISSUE A
Date of Issue | 31.01.2024

70303 | UNITING CARE | 24A KINGSCLIFF STREET, KINGSCLIFF, NSW 2487

DATE	DESCRIPTION	BY	CHK	REV
31.01.2024	FOR DA SUBMISSION	VP	CLIENT & CST	A

DISCLAIMER
In accepting and utilising this document the recipient agrees that Plus Architecture Pty. Ltd. ACN 091 690 336, retain all common law, statutory law and other rights including copyright and intellectual property rights. The recipient agrees not to use this document for any purpose other than its intended use; to waive all claims against Plus Architecture resulting from unauthorised changes; or to reuse the document on other projects without the prior written consent of Plus Architecture. Under no circumstances shall transfer of this document be deemed a sale. Plus Architecture makes no warranties of fitness for any purpose. The Builder/Contractor shall verify job dimensions prior to any work commencing. Figured dimensions shall take precedence over scaled work.



NOMINATED ARCHITECTS NSW - Amit Julka 10002; Rido Pin 11286
Level 4, 222 Clarence Street
Sydney NSW 2000
sydney@plusarchitecture.com.au
www.plusarchitecture.com.au
TELEPHONE +61 2 8823 7000
Plus Architecture Sydney Pty Ltd
ACN 618393338

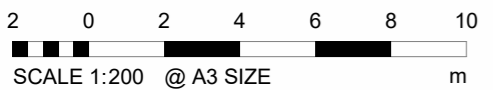
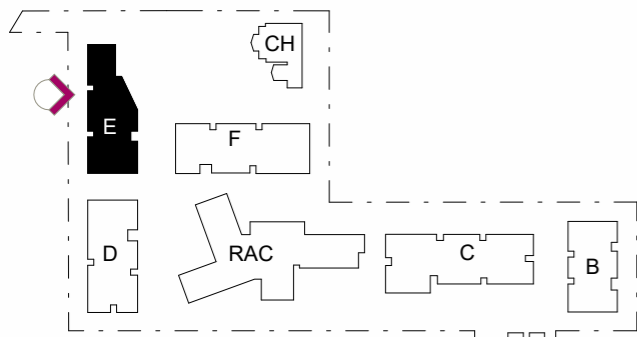

ISSUE A
Date of Issue | 16.02.2024

70303 | UNITING CARE | 24A KINGSCLIFF STREET, KINGSCLIFF, NSW 2487

DATE	DESCRIPTION	BY	CHK	REV
16.02.2024	FOR DA SUBMISSION	VP	CLIENT & CST	A

DISCLAIMER
In accepting and utilising this document the recipient agrees that Plus Architecture Pty. Ltd. ACN 091 690 336, retain all common law, statutory law and other rights including copyright and intellectual property rights. The recipient agrees not to use this document for any purpose other than its intended use; to waive all claims against Plus Architecture resulting from unauthorised changes; or to reuse the document on other projects without the prior written consent of Plus Architecture. Under no circumstances shall transfer of this document be deemed a sale. Plus Architecture makes no warranties of fitness for any purpose. The Builder/Contractor shall verify job dimensions prior to any work commencing. Figured dimensions shall take precedence over scaled work.



EXTERNAL FINISHES LEGEND

- BR1 BRICK TYPE 1
- BR2 BRICK TYPE 2
- BR3 BRICK TYPE 3
- BR4 BRICK TYPE 4
- GL1 GLAZING
- GL2 FRITTED GLAZING
- M1 METAL FINISH - CHARCOAL
- M2 METAL FINISH - BRONZE
- M3 METAL CLADDING - CHARCOAL
- M4 METAL CLADDING - GREY
- M5 METAL CLADDING - BRONZE
- P1 PAINT FINISH - DARK CHARCOAL
- P2 PAINT FINISH - GREY
- P3 PAINT FINISH - OFF WHITE
- P4 PAINT FINISH - TO MATCH M2
- P5 PAINT FINISH - OFF WHITE
- ST1 VERTICAL SCORING PRE-FINISHED FC CLADDING

NOMINATED ARCHITECTS NSW - Amit Julka 10002; Rido Pin 11286
 Level 4, 222 Clarence Street TELEPHONE +61 2 8823 7000
 Sydney NSW 2000 Plus Architecture Sydney Pty Ltd
 www.plusarchitecture.com.au ACN 618393338

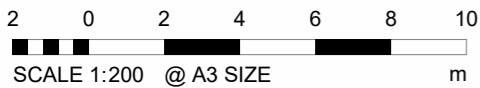
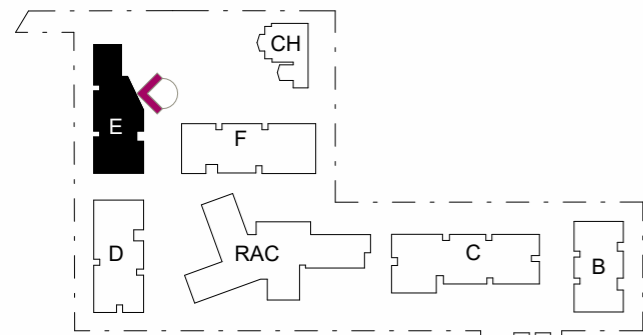

ISSUE A
Date of Issue | 16.02.2024

70303 | UNITING CARE | 24A KINGSCLIFF STREET, KINGSCLIFF, NSW 2487

DATE	DESCRIPTION	BY	CHK	REV
16.02.2024	FOR DA SUBMISSION	VP	CLIENT & CST	A

DISCLAIMER
In accepting and utilising this document the recipient agrees that Plus Architecture Pty. Ltd. ACN 091 690 336, retain all common law, statutory law and other rights including copyright and intellectual property rights. The recipient agrees not to use this document for any purpose other than its intended use; to waive all claims against Plus Architecture resulting from unauthorised changes; or to reuse the document on other projects without the prior written consent of Plus Architecture. Under no circumstances shall transfer of this document be deemed a sale. Plus Architecture makes no warranties of fitness for any purpose. The Builder/Contractor shall verify job dimensions prior to any work commencing. Figured dimensions shall take precedence over scaled work.



EXTERNAL FINISHES LEGEND

- BR1 BRICK TYPE 1
- BR2 BRICK TYPE 2
- BR3 BRICK TYPE 3
- BR4 BRICK TYPE 4
- GL1 GLAZING
- GL2 FRITTED GLAZING
- M1 METAL FINISH - CHARCOAL
- M2 METAL FINISH - BRONZE
- M3 METAL CLADDING - CHARCOAL
- M4 METAL CLADDING - GREY
- M5 METAL CLADDING - BRONZE
- P1 PAINT FINISH - DARK CHARCOAL
- P2 PAINT FINISH - GREY
- P3 PAINT FINISH - OFF WHITE
- P4 PAINT FINISH - TO MATCH M2
- P5 PAINT FINISH - OFF WHITE
- ST1 VERTICAL SCORING PRE-FINISHED FC CLADDING

NOMINATED ARCHITECTS NSW - Amit Julka 10002; Rido Pin 11286
 Level 4, 222 Clarence Street TELEPHONE +61 2 8823 7000
 Sydney NSW 2000
 sydney@plusarchitecture.com.au Plus Architecture Sydney Pty Ltd
 www.plusarchitecture.com.au ACN 618393338

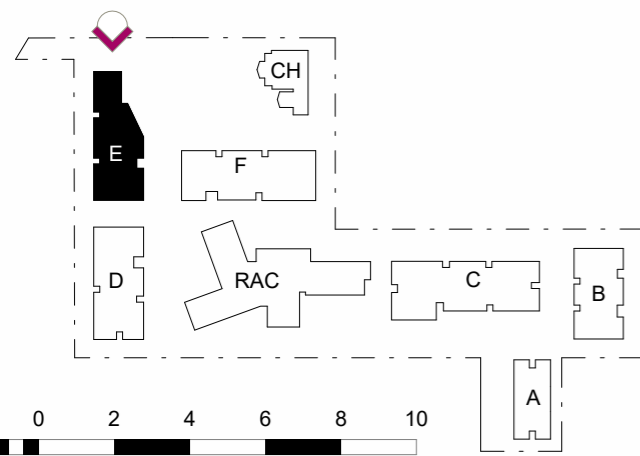

2 0 2 4 6 8 10
SCALE 1:200 @ A3 SIZE m

ISSUE A
Date of Issue | 16.02.2024

70303 | UNITING CARE | 24A KINGSCLIFF STREET, KINGSCLIFF, NSW 2487

DATE	DESCRIPTION	BY	CHK	REV
16.02.2024	FOR DA SUBMISSION	VP	CLIENT & CST	A

DISCLAIMER
In accepting and utilising this document the recipient agrees that Plus Architecture Pty. Ltd. ACN 091 690 336, retain all common law, statutory law and other rights including copyright and intellectual property rights. The recipient agrees not to use this document for any purpose other than its intended use; to waive all claims against Plus Architecture resulting from unauthorised changes; or to reuse the document on other projects without the prior written consent of Plus Architecture. Under no circumstances shall transfer of this document be deemed a sale. Plus Architecture makes no warranties of fitness for any purpose. The Builder/Contractor shall verify job dimensions prior to any work commencing. Figured dimensions shall take precedence over scaled work.



EXTERNAL FINISHES LEGEND

- BR1 BRICK TYPE 1
- BR2 BRICK TYPE 2
- BR3 BRICK TYPE 3
- BR4 BRICK TYPE 4
- GL1 GLAZING
- GL2 FRITTED GLAZING
- M1 METAL FINISH - CHARCOAL
- M2 METAL FINISH - BRONZE
- M3 METAL CLADDING - CHARCOAL
- M4 METAL CLADDING - GREY
- M5 METAL CLADDING - BRONZE
- P1 PAINT FINISH - DARK CHARCOAL
- P2 PAINT FINISH - GREY
- P3 PAINT FINISH - OFF WHITE
- P4 PAINT FINISH - TO MATCH M2
- P5 PAINT FINISH - OFF WHITE
- ST1 VERTICAL SCORING PRE-FINISHED FC CLADDING

NOMINATED ARCHITECTS NSW - Amit Julka 10002; Rido Pin 11286
Level 4, 222 Clarence Street TELEPHONE +61 2 8823 7000
Sydney NSW 2000
sydney@plusarchitecture.com.au Plus Architecture Sydney Pty Ltd
www.plusarchitecture.com.au ACN 618393338

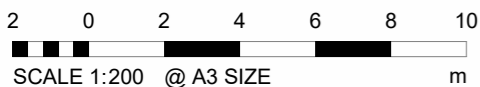
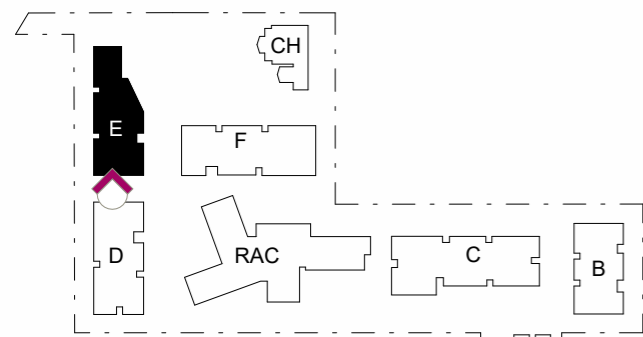

ISSUE A
Date of Issue | 16.02.2024

70303 | UNITING CARE | 24A KINGSCLIFF STREET, KINGSCLIFF, NSW 2487

DATE	DESCRIPTION	BY	CHK	REV
16.02.2024	FOR DA SUBMISSION	VP	CLIENT & CST	A

DISCLAIMER
In accepting and utilising this document the recipient agrees that Plus Architecture Pty. Ltd. ACN 091 690 336, retain all common law, statutory law and other rights including copyright and intellectual property rights. The recipient agrees not to use this document for any purpose other than its intended use; to waive all claims against Plus Architecture resulting from unauthorised changes; or to reuse the document on other projects without the prior written consent of Plus Architecture. Under no circumstances shall transfer of this document be deemed a sale. Plus Architecture makes no warranties of fitness for any purpose. The Builder/Contractor shall verify job dimensions prior to any work commencing. Figured dimensions shall take precedence over scaled work.



EXTERNAL FINISHES LEGEND

- BR1 BRICK TYPE 1
- BR2 BRICK TYPE 2
- BR3 BRICK TYPE 3
- BR4 BRICK TYPE 4
- GL1 GLAZING
- GL2 FRITTED GLAZING
- M1 METAL FINISH - CHARCOAL
- M2 METAL FINISH - BRONZE
- M3 METAL CLADDING - CHARCOAL
- M4 METAL CLADDING - GREY
- M5 METAL CLADDING - BRONZE
- P1 PAINT FINISH - DARK CHARCOAL
- P2 PAINT FINISH - GREY
- P3 PAINT FINISH - OFF WHITE
- P4 PAINT FINISH - TO MATCH M2
- P5 PAINT FINISH - OFF WHITE
- ST1 VERTICAL SCORING PRE-FINISHED FC CLADDING

NOMINATED ARCHITECTS NSW - Amit Julka 10002; Rido Pin 11286
Level 4, 222 Clarence Street TELEPHONE +61 2 8823 7000
Sydney NSW 2000
www.plusarchitecture.com.au Plus Architecture Sydney Pty Ltd
sydney@plusarchitecture.com.au ACN 618393338

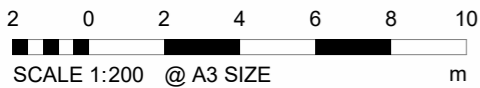
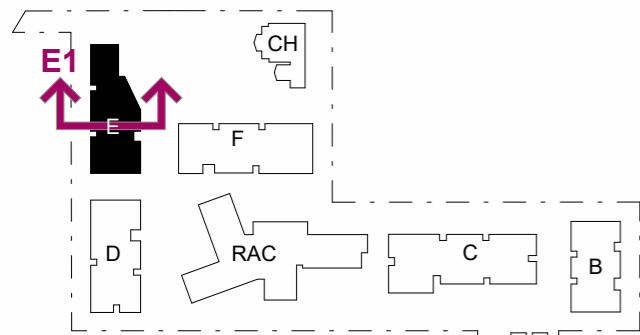

ISSUE A
Date of Issue | 16.02.2024

DATE	DESCRIPTION	BY	CHK	REV
16.02.2024	FOR DA SUBMISSION	VP	CLIENT & CST	A

DISCLAIMER
In accepting and utilising this document the recipient agrees that Plus Architecture Pty. Ltd. ACN 091 690 336, retain all common law, statutory law and other rights including copyright and intellectual property rights. The recipient agrees not to use this document for any purpose other than its intended use; to waive all claims against Plus Architecture resulting from unauthorised changes; or to reuse the document on other projects without the prior written consent of Plus Architecture. Under no circumstances shall transfer of this document be deemed a sale. Plus Architecture makes no warranties of fitness for any purpose. The Builder/Contractor shall verify job dimensions prior to any work commencing. Figured dimensions shall take precedence over scaled work.



NOMINATED ARCHITECTS NSW - Amit Julka 10002; Rido Pin 11286
Level 4, 222 Clarence Street
Sydney NSW 2000
sydney@plusarchitecture.com.au
www.plusarchitecture.com.au
TELEPHONE +61 2 8823 7000
Plus Architecture Sydney Pty Ltd
ACN 618393338

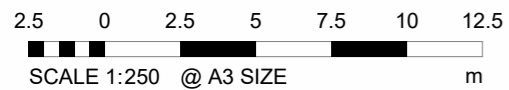
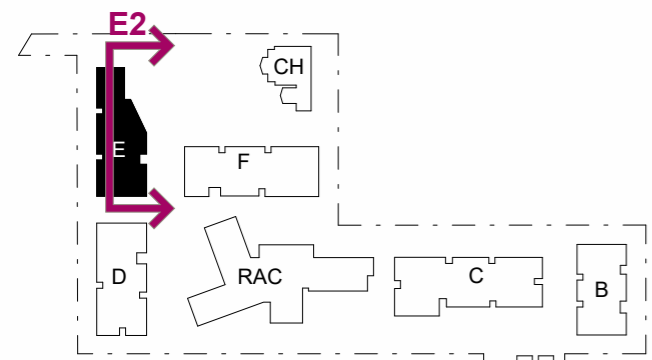

ISSUE A
Date of Issue | 16.02.2024

DATE	DESCRIPTION	BY	CHK	REV
16.02.2024	FOR DA SUBMISSION	VP	CLIENT & CST	A

DISCLAIMER
In accepting and utilising this document the recipient agrees that Plus Architecture Pty. Ltd. ACN 091 690 336, retain all common law, statutory law and other rights including copyright and intellectual property rights. The recipient agrees not to use this document for any purpose other than its intended use; to waive all claims against Plus Architecture resulting from unauthorised changes; or to reuse the document on other projects without the prior written consent of Plus Architecture. Under no circumstances shall transfer of this document be deemed a sale. Plus Architecture makes no warranties of fitness for any purpose. The Builder/Contractor shall verify job dimensions prior to any work commencing. Figured dimensions shall take precedence over scaled work.



NOMINATED ARCHITECTS NSW - Amit Julka 10002; Rido Pin 11286
Level 4, 222 Clarence Street
Sydney NSW 2000
sydney@plusarchitecture.com.au
www.plusarchitecture.com.au
TELEPHONE +61 2 8823 7000
Plus Architecture Sydney Pty Ltd
ACN 618393338

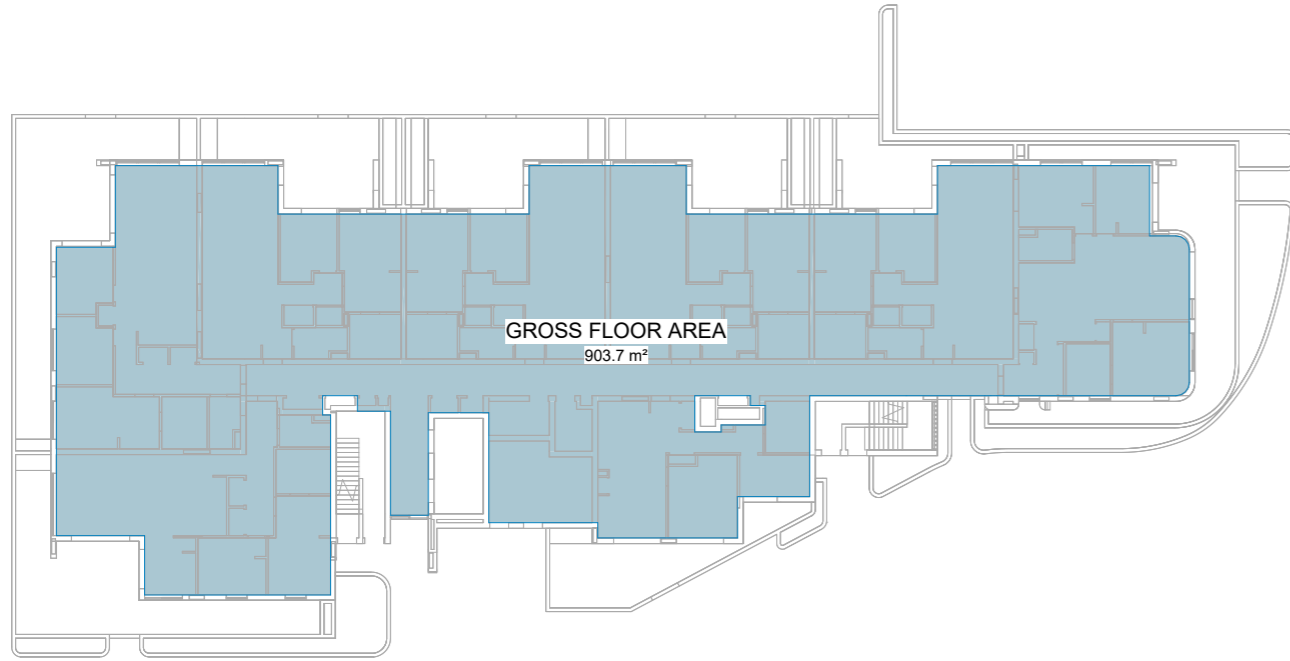

AREA PLAN (GFA)
GROUND FLOOR

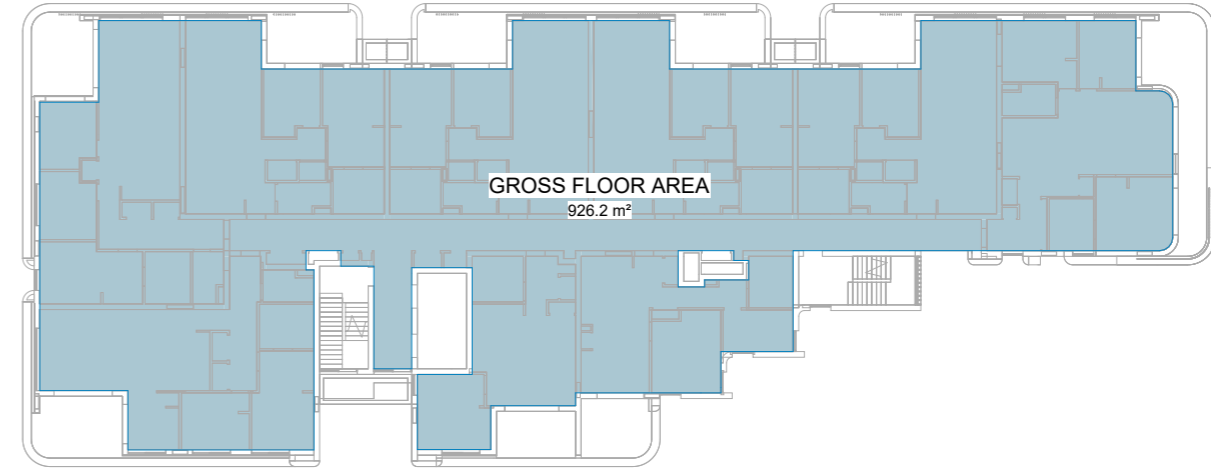

AREA PLAN (GFA)
LEVEL 01 - 02

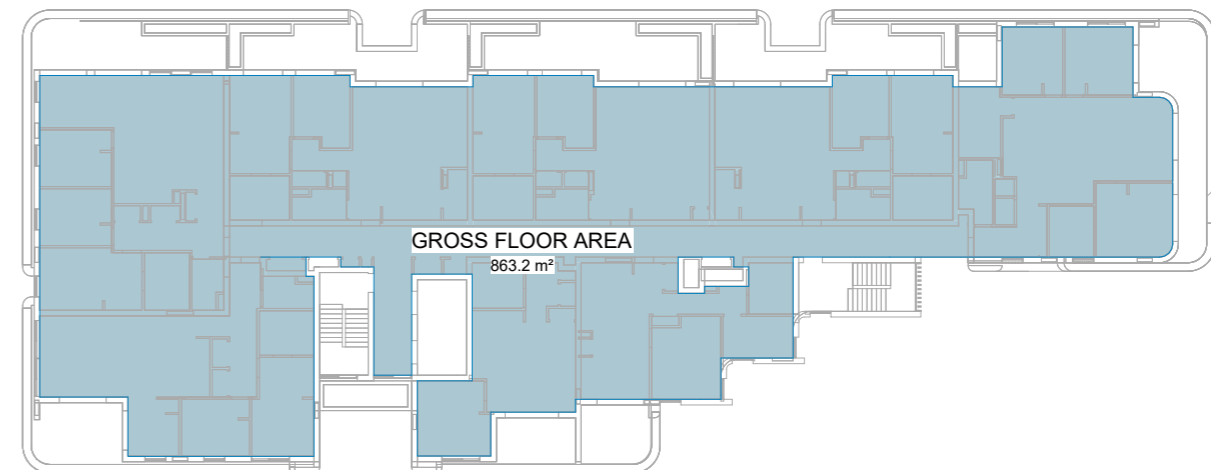

AREA PLAN (GFA)
LEVEL 03

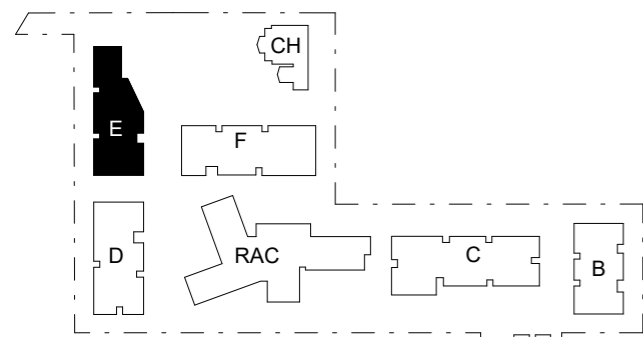

BUILDING E - GROUND LEVEL	903.7 m ²
BUILDING E - LEVEL 01	926.2 m ²
BUILDING E - LEVEL 02	926.2 m ²
BUILDING E - LEVEL 03	863.2 m ²
TOTAL GROSS FLOOR AREA	3619.3 m²

LEGENDS
 GFA

4 0 4 8 12 16 20
 SCALE 1:400 @ A3 SIZE m

ISSUE A
 Date of Issue | 31.01.2024

70303 | UNITING CARE | 24A KINGSCLIFF STREET, KINGSCLIFF, NSW 2487

DATE	DESCRIPTION	BY	CHK	REV
31.01.2024	FOR DA SUBMISSION	VP	CLIENT & CST	A

DISCLAIMER
 In accepting and utilising this document the recipient agrees that Plus Architecture Pty. Ltd. ACN 091 690 336, retain all common law, statutory law and other rights including copyright and intellectual property rights. The recipient agrees not to use this document for any purpose other than its intended use; to waive all claims against Plus Architecture resulting from unauthorised changes; or to reuse the document on other projects without the prior written consent of Plus Architecture. Under no circumstances shall transfer of this document be deemed a sale. Plus Architecture makes no warranties of fitness for any purpose. The Builder/Contractor shall verify job dimensions prior to any work commencing. Figured dimensions shall take precedence over scaled work.



NOMINATED ARCHITECTS NSW - Amit Julka 10002; Rido Pin 11286
 Level 4, 222 Clarence Street TELEPHONE +61 2 8823 7000
 Sydney NSW 2000
 sydney@plusarchitecture.com.au Plus Architecture Sydney Pty Ltd
 www.plusarchitecture.com.au ACN 618393338

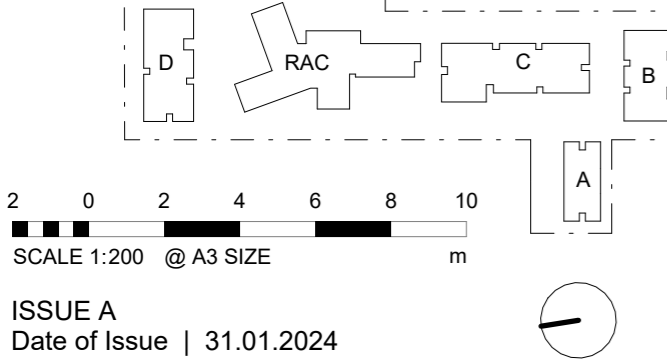

LEGEND

CER	CARPARK EXHAUST RISER	GE	CLN ROOM EXHAUST RISER
CSA	CARPARK SUPPLY AIR	HYD	HYDRAULIC RISER
ER	ELECTRICAL RISER	MR	MECHANICAL RISER
FE	FIRE EXTINGUISHER	OA	OUTSIDE AIR
FIP	FIRE INDICATOR PANEL	SC	SPRINKLER CONTROL

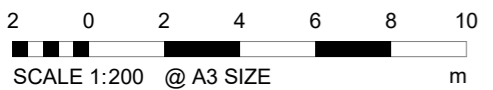

ISSUE A
Date of Issue | 31.01.2024

DATE	DESCRIPTION	BY	CHK	REV
31.01.2024	FOR DA SUBMISSION	VP	CLIENT & CST	A

DISCLAIMER
In accepting and utilising this document the recipient agrees that Plus Architecture Pty. Ltd. ACN 091 690 336, retain all common law, statutory law and other rights including copyright and intellectual property rights. The recipient agrees not to use this document for any purpose other than its intended use; to waive all claims against Plus Architecture resulting from unauthorised changes; or to reuse the document on other projects without the prior written consent of Plus Architecture. Under no circumstances shall transfer of this document be deemed a sale. Plus Architecture makes no warranties of fitness for any purpose. The Builder/Contractor shall verify job dimensions prior to any work commencing. Figured dimensions shall take precedence over scaled work.



NOMINATED ARCHITECTS NSW - Amit Julka 10002; Rido Pin 11286
 Level 4, 222 Clarence Street
 Sydney NSW 2000
 sydney@plusarchitecture.com.au
 www.plusarchitecture.com.au
 TELEPHONE +61 2 8823 7000
 Plus Architecture Sydney Pty Ltd
 ACN 618393338



F.202
2 BED
92.0 m²
BALCONY
21.6 m²

F.203
2 BED
90.7 m²
BALCONY
10.7 m²

F.204
2 BED
90.7 m²
BALCONY
10.7 m²

F.205
2 BED
93.7 m²
BALCONY
10.7 m²

F.206
2 BED
90.7 m²
BALCONY
10.7 m²

F.207
3 BED
106.7 m²
BALCONY
12.3 m²

F.201
2 BED
87.8 m²
BALCONY
17.5 m²

F.211
1 BED
57.2 m²
BALCONY
9.6 m²

F.210
2 BED
90.8 m²
BALCONY
16.0 m²

F.209
2 BED
90.7 m²
BALCONY
12.2 m²

F.208
3 BED
108.7 m²
BALCONY
12.2 m²

SITE SETBACK

9000
SETBACK

SITE BOUNDARY

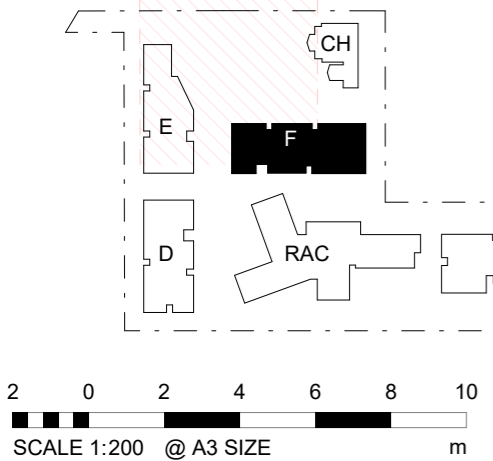
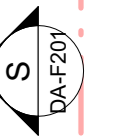

LEGEND

CER	CARPARK EXHAUST RISER	GE	CLN ROOM EXHAUST RISER
CSA	CARPARK SUPPLY AIR	HYD	HYDRAULIC RISER
ER	ELECTRICAL RISER	MR	MECHANICAL RISER
FE	FIRE EXTINGUISHER	OA	OUTSIDE AIR
FIP	FIRE INDICATOR PANEL	SC	SPRINKLER CONTROL

DATE	DESCRIPTION	BY	CHK	REV
31.01.2024	FOR DA SUBMISSION	VP	CLIENT & CST	A

DISCLAIMER
In accepting and utilising this document the recipient agrees that Plus Architecture Pty. Ltd. ACN 091 690 336, retain all common law, statutory law and other rights including copyright and intellectual property rights. The recipient agrees not to use this document for any purpose other than its intended use; to waive all claims against Plus Architecture resulting from unauthorised changes; or to reuse the document on other projects without the prior written consent of Plus Architecture. Under no circumstances shall transfer of this document be deemed a sale. Plus Architecture makes no warranties of fitness for any purpose. The Builder/Contractor shall verify job dimensions prior to any work commencing. Figured dimensions shall take precedence over scaled work.



NOMINATED ARCHITECTS NSW - Amit Julka 10002; Rido Pin 11286
Level 4, 222 Clarence Street
Sydney NSW 2000
sydney@plusarchitecture.com.au
www.plusarchitecture.com.au
TELEPHONE +61 2 8823 7000
Plus Architecture Sydney Pty Ltd
ACN 618393338

ISSUE A
Date of Issue | 31.01.2024

70303 | UNITING CARE | 24A KINGSCLIFF STREET, KINGSCLIFF, NSW 2487

JANUARY 2024 | DEVELOPMENT APPLICATION | PLUS ARCHITECTURE

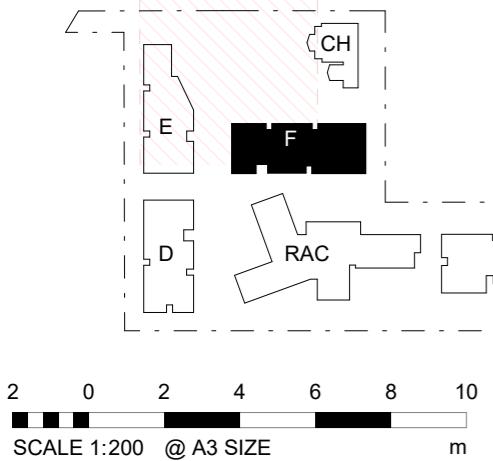

ISSUE A
Date of Issue | 31.01.2024

70303 | UNITING CARE | 24A KINGSCLIFF STREET, KINGSCLIFF, NSW 2487

LEGEND

CER	CARPARK EXHAUST RISER	GE	CLN ROOM EXHAUST RISER
CSA	CARPARK SUPPLY AIR	HYD	HYDRAULIC RISER
ER	ELECTRICAL RISER	MR	MECHANICAL RISER
FE	FIRE EXTINGUISHER	OA	OUTSIDE AIR
FIP	FIRE INDICATOR PANEL	SC	SPRINKLER CONTROL

DATE	DESCRIPTION	BY	CHK	REV
31.01.2024	FOR DA SUBMISSION	VP	CLIENT & CST	A

DISCLAIMER
In accepting and utilising this document the recipient agrees that Plus Architecture Pty. Ltd. ACN 091 690 336, retain all common law, statutory law and other rights including copyright and intellectual property rights. The recipient agrees not to use this document for any purpose other than its intended use; to waive all claims against Plus Architecture resulting from unauthorised changes; or to reuse the document on other projects without the prior written consent of Plus Architecture. Under no circumstances shall transfer of this document be deemed a sale. Plus Architecture makes no warranties of fitness for any purpose. The Builder/Contractor shall verify job dimensions prior to any work commencing. Figured dimensions shall take precedence over scaled work.



NOMINATED ARCHITECTS NSW - Amit Julka 10002; Rido Pin 11286
 Level 4, 222 Clarence Street
 Sydney NSW 2000
 sydney@plusarchitecture.com.au
 www.plusarchitecture.com.au
 TELEPHONE +61 2 8823 7000
 Plus Architecture Sydney Pty Ltd
 ACN 618393338

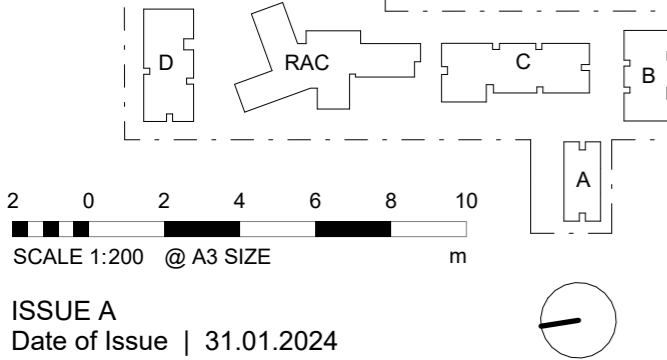
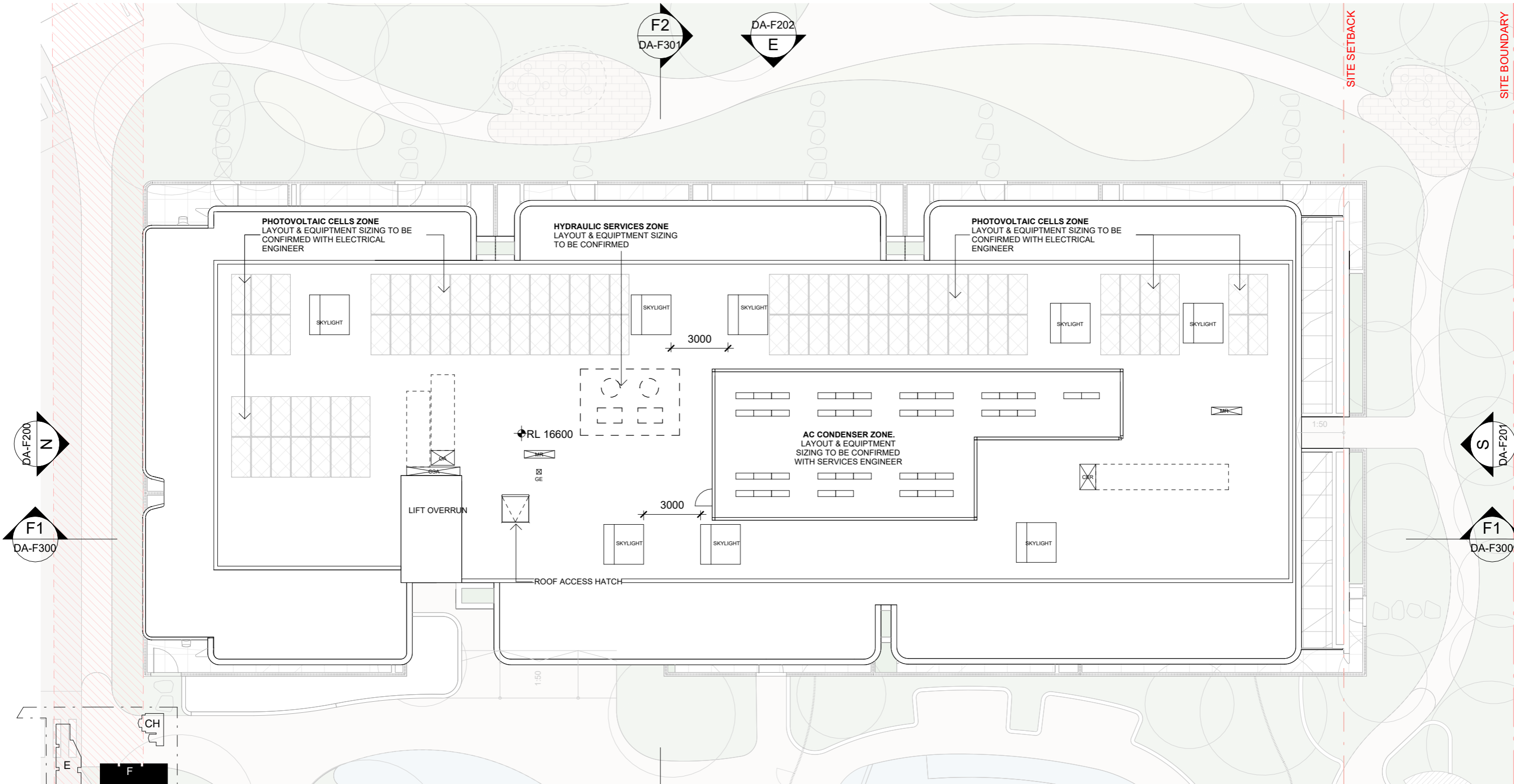

LEGEND

CER	CARPARK EXHAUST RISER	GE	CLN ROOM EXHAUST RISER
CSA	CARPARK SUPPLY AIR	HYD	HYDRAULIC RISER
ER	ELECTRICAL RISER	MR	MECHANICAL RISER
FE	FIRE EXTINGUISHER	OA	OUTSIDE AIR
FIP	FIRE INDICATOR PANEL	SC	SPRINKLER CONTROL

DATE	DESCRIPTION	BY	CHK	REV
31.01.2024	FOR DA SUBMISSION	VP	CLIENT & CST	A

DISCLAIMER
 In accepting and utilising this document the recipient agrees that Plus Architecture Pty. Ltd. ACN 091 690 336, retain all common law, statutory law and other rights including copyright and intellectual property rights. The recipient agrees not to use this document for any purpose other than its intended use; to waive all claims against Plus Architecture resulting from unauthorised changes; or to reuse the document on other projects without the prior written consent of Plus Architecture. Under no circumstances shall transfer of this document be deemed a sale. Plus Architecture makes no warranties of fitness for any purpose. The Builder/Contractor shall verify job dimensions prior to any work commencing. Figured dimensions shall take precedence over scaled work.



NOMINATED ARCHITECTS NSW - Amit Julka 10002; Rido Pin 11286
 Level 4, 222 Clarence Street
 Sydney NSW 2000
 sydney@plusarchitecture.com.au
 www.plusarchitecture.com.au
 TELEPHONE +61 2 8823 7000
 Plus Architecture Sydney Pty Ltd
 ACN 618393338

ISSUE A
 Date of Issue | 31.01.2024

70303 | UNITING CARE | 24A KINGSCLIFF STREET, KINGSCLIFF, NSW 2487

JANUARY 2024 | DEVELOPMENT APPLICATION | PLUS ARCHITECTURE

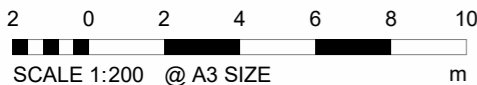
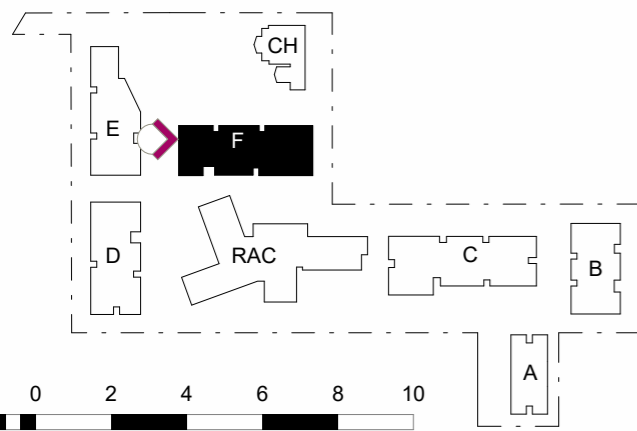
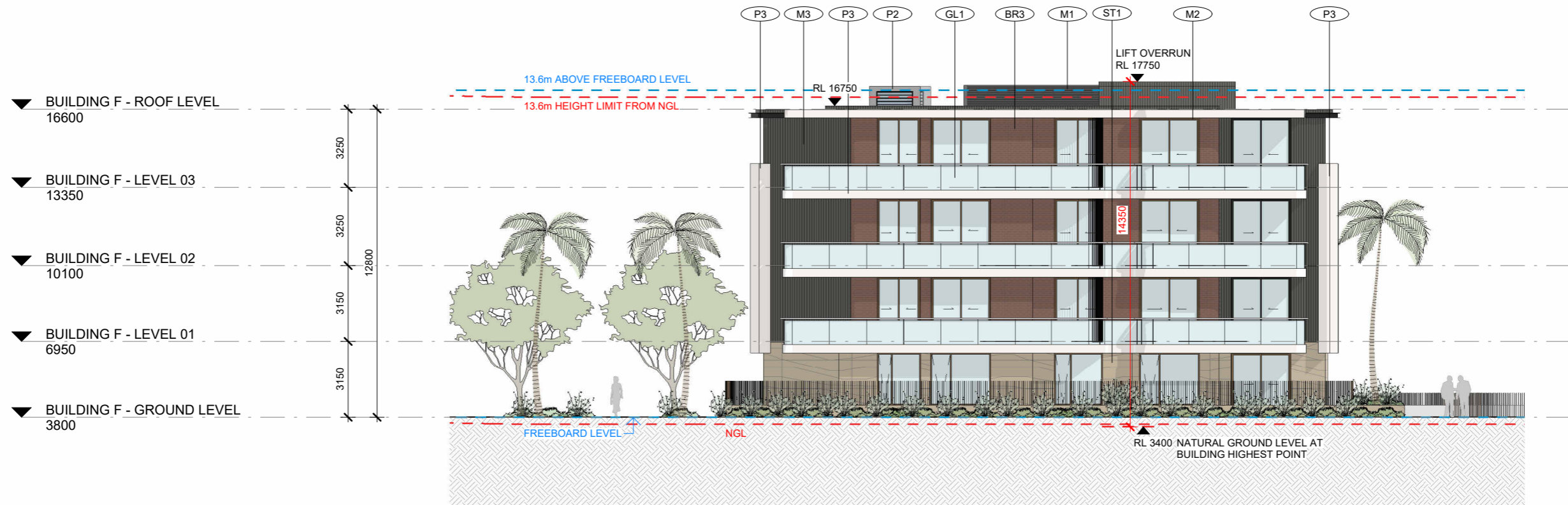

ISSUE A
Date of Issue | 16.02.2024

70303 | UNITING CARE | 24A KINGSCLIFF STREET, KINGSCLIFF, NSW 2487

DATE	DESCRIPTION	BY	CHK	REV
16.02.2024	FOR DA SUBMISSION	VP	CLIENT & CST	A

DISCLAIMER
In accepting and utilising this document the recipient agrees that Plus Architecture Pty. Ltd. ACN 091 690 336, retain all common law, statutory law and other rights including copyright and intellectual property rights. The recipient agrees not to use this document for any purpose other than its intended use; to waive all claims against Plus Architecture resulting from unauthorised changes; or to reuse the document on other projects without the prior written consent of Plus Architecture. Under no circumstances shall transfer of this document be deemed a sale. Plus Architecture makes no warranties of fitness for any purpose. The Builder/Contractor shall verify job dimensions prior to any work commencing. Figured dimensions shall take precedence over scaled work.



EXTERNAL FINISHES LEGEND

- BR1** BRICK TYPE 1
- BR2** BRICK TYPE 2
- BR3** BRICK TYPE 3
- BR4** BRICK TYPE 4
- GL1** GLAZING
- GL2** FRITTED GLAZING
- M1** METAL FINISH - CHARCOAL
- M2** METAL FINISH - BRONZE
- M3** METAL CLADDING - CHARCOAL
- M4** METAL CLADDING - GREY
- M5** METAL CLADDING - BRONZE
- P1** PAINT FINISH - DARK CHARCOAL
- P2** PAINT FINISH - GREY
- P3** PAINT FINISH - OFF WHITE
- P4** PAINT FINISH - TO MATCH M2
- P5** PAINT FINISH - OFF WHITE
- ST1** VERTICAL SCORING PRE-FINISHED FC CLADDING

NOMINATED ARCHITECTS NSW - Amit Julka 10002; Rido Pin 11286
 Level 4, 222 Clarence Street TELEPHONE +61 2 8823 7000
 Sydney NSW 2000
 sydney@plusarchitecture.com.au Plus Architecture Sydney Pty Ltd
 www.plusarchitecture.com.au ACN 618393338

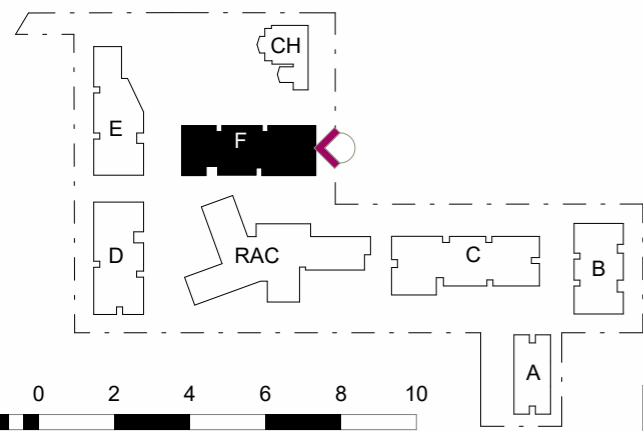

2 0 2 4 6 8 10
SCALE 1:200 @ A3 SIZE m

ISSUE A
Date of Issue | 16.02.2024

70303 | UNITING CARE | 24A KINGSCLIFF STREET, KINGSCLIFF, NSW 2487

DATE	DESCRIPTION	BY	CHK	REV
16.02.2024	FOR DA SUBMISSION	VP	CLIENT & CST	A

DISCLAIMER
In accepting and utilising this document the recipient agrees that Plus Architecture Pty. Ltd. ACN 091 690 336, retain all common law, statutory law and other rights including copyright and intellectual property rights. The recipient agrees not to use this document for any purpose other than its intended use; to waive all claims against Plus Architecture resulting from unauthorised changes; or to reuse the document on other projects without the prior written consent of Plus Architecture. Under no circumstances shall transfer of this document be deemed a sale. Plus Architecture makes no warranties of fitness for any purpose. The Builder/Contractor shall verify job dimensions prior to any work commencing. Figured dimensions shall take precedence over scaled work.



EXTERNAL FINISHES LEGEND

- BR1** BRICK TYPE 1
- BR2** BRICK TYPE 2
- BR3** BRICK TYPE 3
- BR4** BRICK TYPE 4
- GL1** GLAZING
- GL2** FRITTED GLAZING
- M1** METAL FINISH - CHARCOAL
- M2** METAL FINISH - BRONZE
- M3** METAL CLADDING - CHARCOAL
- M4** METAL CLADDING - GREY
- M5** METAL CLADDING - BRONZE
- P1** PAINT FINISH - DARK CHARCOAL
- P2** PAINT FINISH - GREY
- P3** PAINT FINISH - OFF WHITE
- P4** PAINT FINISH - TO MATCH M2
- P5** PAINT FINISH - OFF WHITE
- ST1** VERTICAL SCORING
- ST1** PRE-FINISHED FC CLADDING

NOMINATED ARCHITECTS NSW - Amit Julka 10002; Rido Pin 11286
Level 4, 222 Clarence Street TELEPHONE +61 2 8823 7000
Sydney NSW 2000
sydney@plusarchitecture.com.au Plus Architecture Sydney Pty Ltd
www.plusarchitecture.com.au ACN 618393338

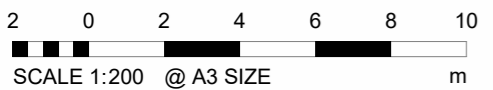
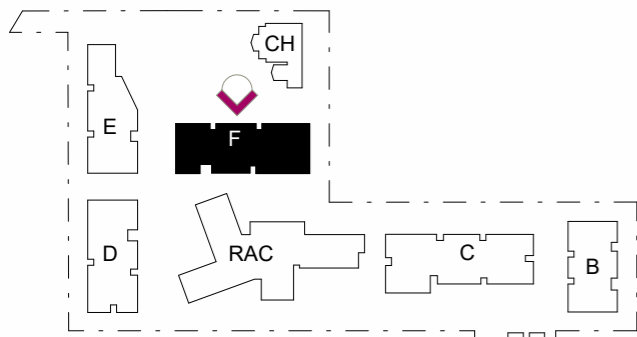

ISSUE A
Date of Issue | 16.02.2024

70303 | UNITING CARE | 24A KINGSCLIFF STREET, KINGSCLIFF, NSW 2487

DATE	DESCRIPTION	BY	CHK	REV
16.02.2024	FOR DA SUBMISSION	VP	CLIENT & CST	A

DISCLAIMER
In accepting and utilising this document the recipient agrees that Plus Architecture Pty. Ltd. ACN 091 690 336, retain all common law, statutory law and other rights including copyright and intellectual property rights. The recipient agrees not to use this document for any purpose other than its intended use; to waive all claims against Plus Architecture resulting from unauthorised changes; or to reuse the document on other projects without the prior written consent of Plus Architecture. Under no circumstances shall transfer of this document be deemed a sale. Plus Architecture makes no warranties of fitness for any purpose. The Builder/Contractor shall verify job dimensions prior to any work commencing. Figured dimensions shall take precedence over scaled work.



EXTERNAL FINISHES LEGEND

- BR1** BRICK TYPE 1
- BR2** BRICK TYPE 2
- BR3** BRICK TYPE 3
- BR4** BRICK TYPE 4
- GL1** GLAZING
- GL2** FRITTED GLAZING
- M1** METAL FINISH - CHARCOAL
- M2** METAL FINISH - BRONZE
- M3** METAL CLADDING - CHARCOAL
- M4** METAL CLADDING - GREY
- M5** METAL CLADDING - BRONZE
- P1** PAINT FINISH - DARK CHARCOAL
- P2** PAINT FINISH - GREY
- P3** PAINT FINISH - OFF WHITE
- P4** PAINT FINISH - TO MATCH M2
- P5** PAINT FINISH - OFF WHITE
- ST1** VERTICAL SCORING
- ST1** PRE-FINISHED FC CLADDING

NOMINATED ARCHITECTS NSW - Amit Julka 10002; Rido Pin 11286
 Level 4, 222 Clarence Street TELEPHONE +61 2 8823 7000
 Sydney NSW 2000
 sydney@plusarchitecture.com.au Plus Architecture Sydney Pty Ltd
 www.plusarchitecture.com.au ACN 618393338

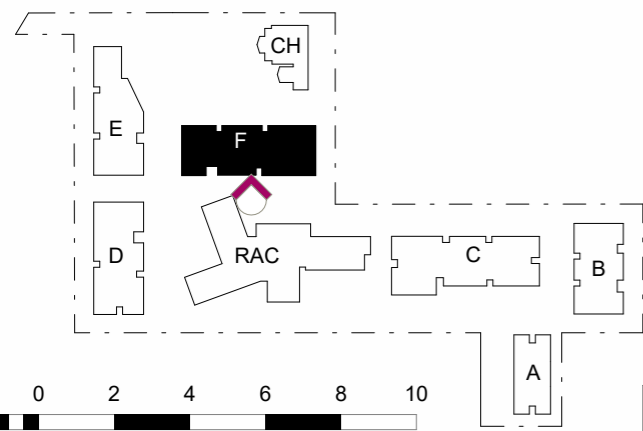

SCALE 1:200 @ A3 SIZE

ISSUE A
Date of Issue | 16.02.2024

70303 | UNITING CARE | 24A KINGSCLIFF STREET, KINGSCLIFF, NSW 2487

DATE	DESCRIPTION	BY	CHK	REV
16.02.2024	FOR DA SUBMISSION	VP	CLIENT & CST	A

DISCLAIMER
In accepting and utilising this document the recipient agrees that Plus Architecture Pty. Ltd. ACN 091 690 336, retain all common law, statutory law and other rights including copyright and intellectual property rights. The recipient agrees not to use this document for any purpose other than its intended use; to waive all claims against Plus Architecture resulting from unauthorised changes; or to reuse the document on other projects without the prior written consent of Plus Architecture. Under no circumstances shall transfer of this document be deemed a sale. Plus Architecture makes no warranties of fitness for any purpose. The Builder/Contractor shall verify job dimensions prior to any work commencing. Figured dimensions shall take precedence over scaled work.



EXTERNAL FINISHES LEGEND

- BR1** BRICK TYPE 1
- BR2** BRICK TYPE 2
- BR3** BRICK TYPE 3
- BR4** BRICK TYPE 4
- GL1** GLAZING
- GL2** FRITTED GLAZING
- M1** METAL FINISH - CHARCOAL
- M2** METAL FINISH - BRONZE
- M3** METAL CLADDING - CHARCOAL
- M4** METAL CLADDING - GREY
- M5** METAL CLADDING - BRONZE
- P1** PAINT FINISH - DARK CHARCOAL
- P2** PAINT FINISH - GREY
- P3** PAINT FINISH - OFF WHITE
- P4** PAINT FINISH - TO MATCH M2
- P5** PAINT FINISH - OFF WHITE
- ST1** VERTICAL SCORING
- ST1** PRE-FINISHED FC CLADDING

NOMINATED ARCHITECTS NSW - Amit Julka 10002; Rido Pin 11286
 Level 4, 222 Clarence Street TELEPHONE +61 2 8823 7000
 Sydney NSW 2000 Plus Architecture Sydney Pty Ltd
 sydney@plusarchitecture.com.au www.plusarchitecture.com.au ACN 618393338

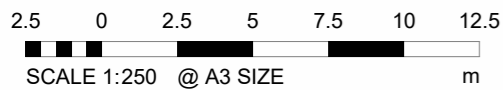
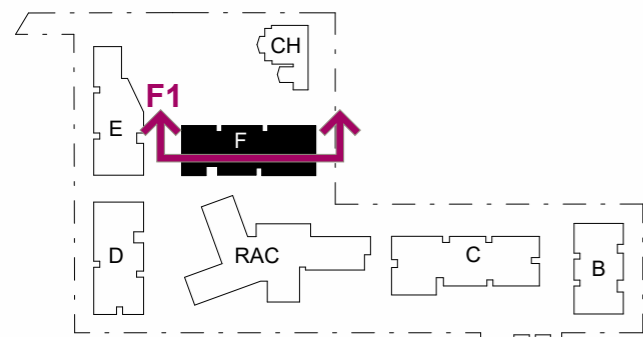

ISSUE A
Date of Issue | 16.02.2024

70303 | UNITING CARE | 24A KINGSCLIFF STREET, KINGSCLIFF, NSW 2487

DATE	DESCRIPTION	BY	CHK	REV
16.02.2024	FOR DA SUBMISSION	VP	CLIENT & CST	A

DISCLAIMER
In accepting and utilising this document the recipient agrees that Plus Architecture Pty. Ltd. ACN 091 690 336, retain all common law, statutory law and other rights including copyright and intellectual property rights. The recipient agrees not to use this document for any purpose other than its intended use; to waive all claims against Plus Architecture resulting from unauthorised changes; or to reuse the document on other projects without the prior written consent of Plus Architecture. Under no circumstances shall transfer of this document be deemed a sale. Plus Architecture makes no warranties of fitness for any purpose. The Builder/Contractor shall verify job dimensions prior to any work commencing. Figured dimensions shall take precedence over scaled work.



NOMINATED ARCHITECTS NSW - Amit Julka 10002; Rido Pin 11286
 Level 4, 222 Clarence Street
 Sydney NSW 2000
 sydney@plusarchitecture.com.au
 www.plusarchitecture.com.au
 TELEPHONE +61 2 8823 7000
 Plus Architecture Sydney Pty Ltd
 ACN 618393338

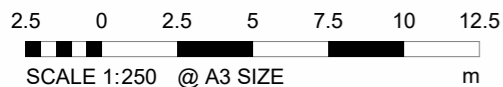
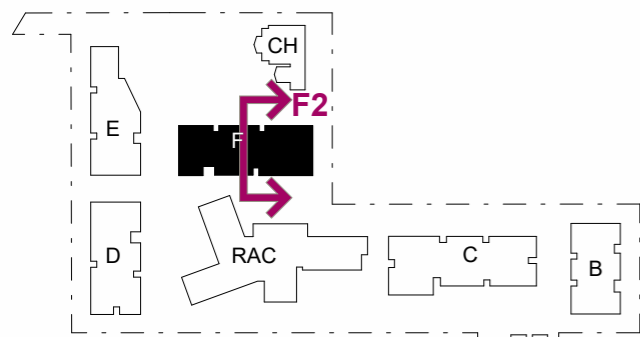
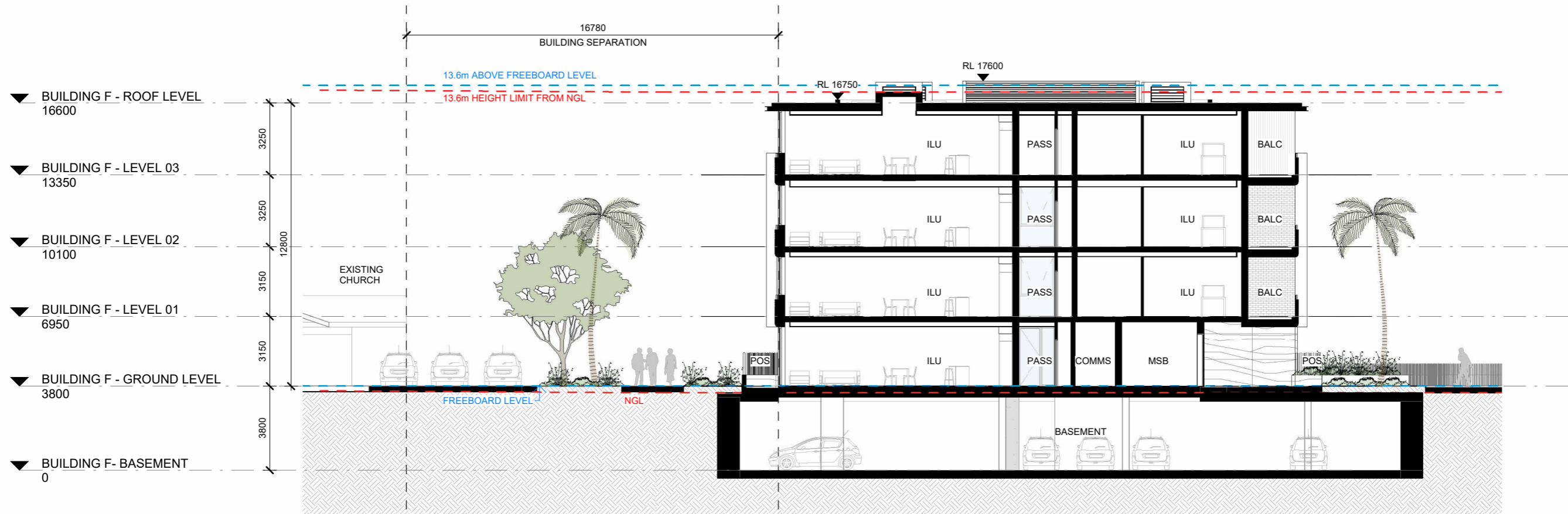

ISSUE A
Date of Issue | 16.02.2024

70303 | UNITING CARE | 24A KINGSCLIFF STREET, KINGSCLIFF, NSW 2487

DATE	DESCRIPTION	BY	CHK	REV
16.02.2024	FOR DA SUBMISSION	VP	CLIENT & CST	A

DISCLAIMER
In accepting and utilising this document the recipient agrees that Plus Architecture Pty. Ltd. ACN 091 690 336, retain all common law, statutory law and other rights including copyright and intellectual property rights. The recipient agrees not to use this document for any purpose other than its intended use; to waive all claims against Plus Architecture resulting from unauthorised changes; or to reuse the document on other projects without the prior written consent of Plus Architecture. Under no circumstances shall transfer of this document be deemed a sale. Plus Architecture makes no warranties of fitness for any purpose. The Builder/Contractor shall verify job dimensions prior to any work commencing. Figured dimensions shall take precedence over scaled work.



NOMINATED ARCHITECTS NSW - Amit Julka 10002; Rido Pin 11286
Level 4, 222 Clarence Street TELEPHONE +61 2 8823 7000
Sydney NSW 2000
sydney@plusarchitecture.com.au Plus Architecture Sydney Pty Ltd
www.plusarchitecture.com.au ACN 618393338

GROSS FLOOR AREA
1114.9 m²

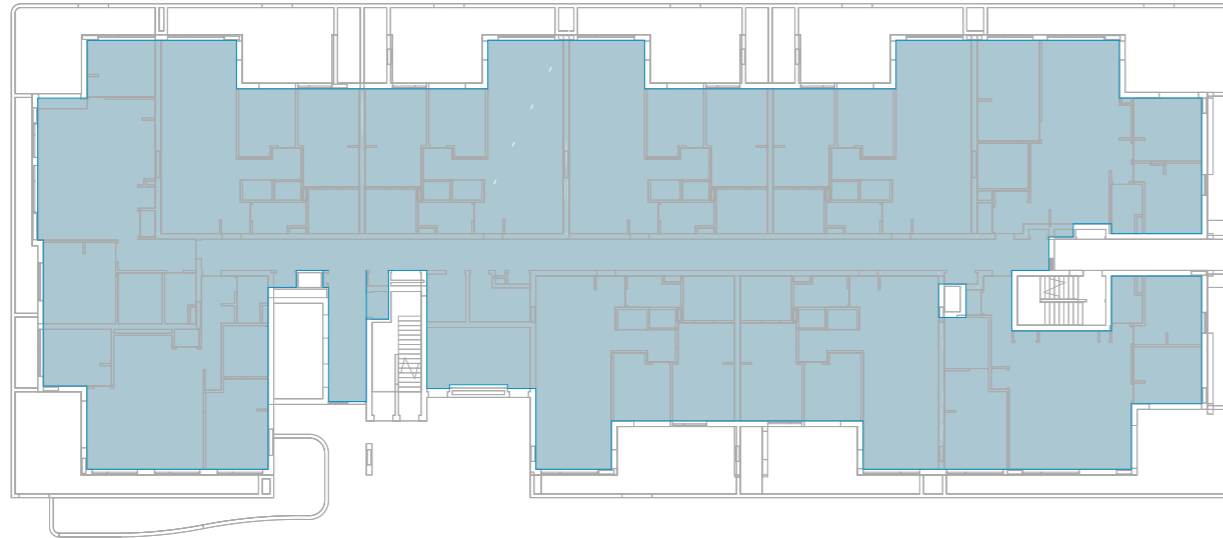

AREA PLAN (GFA)
GROUND FLOOR

GROSS FLOOR AREA
1142.4 m²

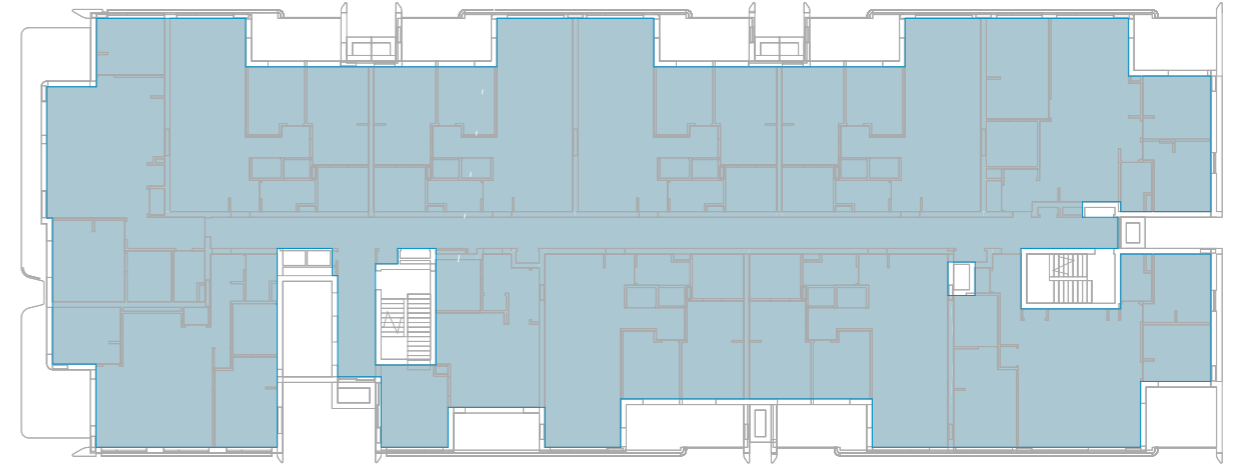

AREA PLAN (GFA)
LEVEL 01

GROSS FLOOR AREA
1053.5 m²

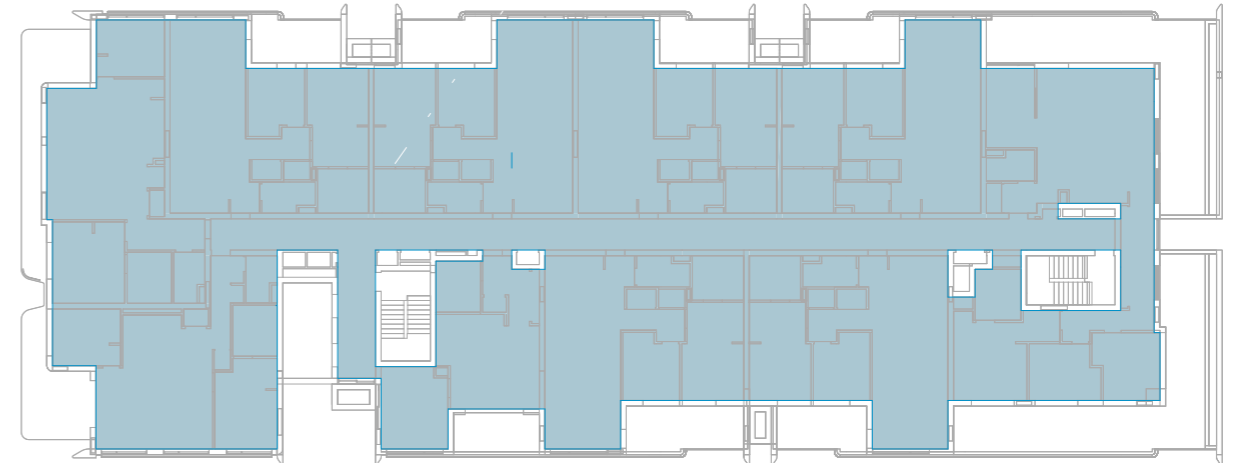

AREA PLAN (GFA)
LEVEL 03

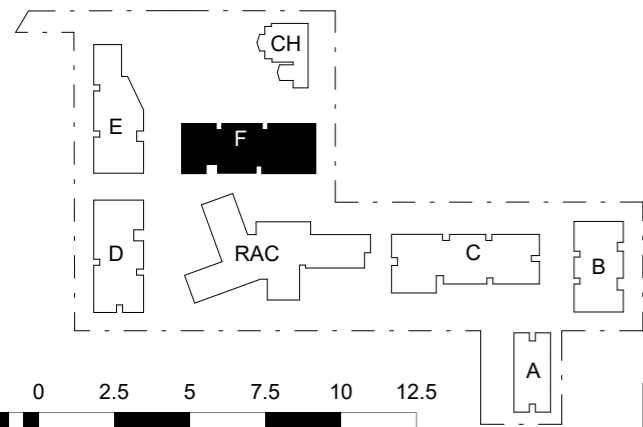

BUILDING F - GROUND LEVEL	1114.9 m ²
BUILDING F - LEVEL 01	1142.4 m ²
BUILDING F - LEVEL 02	1142.4 m ²
BUILDING F - LEVEL 03	1053.5 m ²
TOTAL GROSS FLOOR AREA	4453.1 m²

LEGENDS

GFA

2.5 0 2.5 5 7.5 10 12.5
SCALE 1:250 @ A3 SIZE m

ISSUE A
Date of Issue | 31.01.2024

70303 | UNITING CARE | 24A KINGSCLIFF STREET, KINGSCLIFF, NSW 2487

DATE	DESCRIPTION	BY	CHK	REV
31.01.2024	FOR DA SUBMISSION	VP	CLIENT & CST	A

DISCLAIMER
In accepting and utilising this document the recipient agrees that Plus Architecture Pty. Ltd. ACN 091 690 336, retain all common law, statutory law and other rights including copyright and intellectual property rights. The recipient agrees not to use this document for any purpose other than its intended use; to waive all claims against Plus Architecture resulting from unauthorised changes; or to reuse the document on other projects without the prior written consent of Plus Architecture. Under no circumstances shall transfer of this document be deemed a sale. Plus Architecture makes no warranties of fitness for any purpose. The Builder/Contractor shall verify job dimensions prior to any work commencing. Figured dimensions shall take precedence over scaled work.

Uniting

plus
architecture

NOMINATED ARCHITECTS NSW - Amit Julka 10002; Rido Pin 11286
Level 4, 222 Clarence Street TELEPHONE +61 2 8823 7000
Sydney NSW 2000
sydney@plusarchitecture.com.au Plus Architecture Sydney Pty Ltd
www.plusarchitecture.com.au ACN 618393338

FLOOR PLAN - GROUND LEVEL

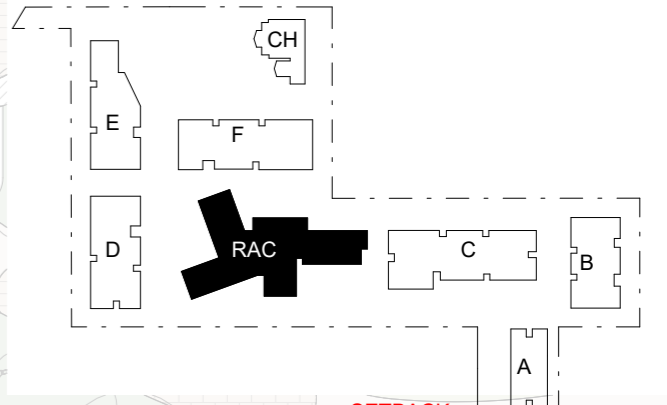
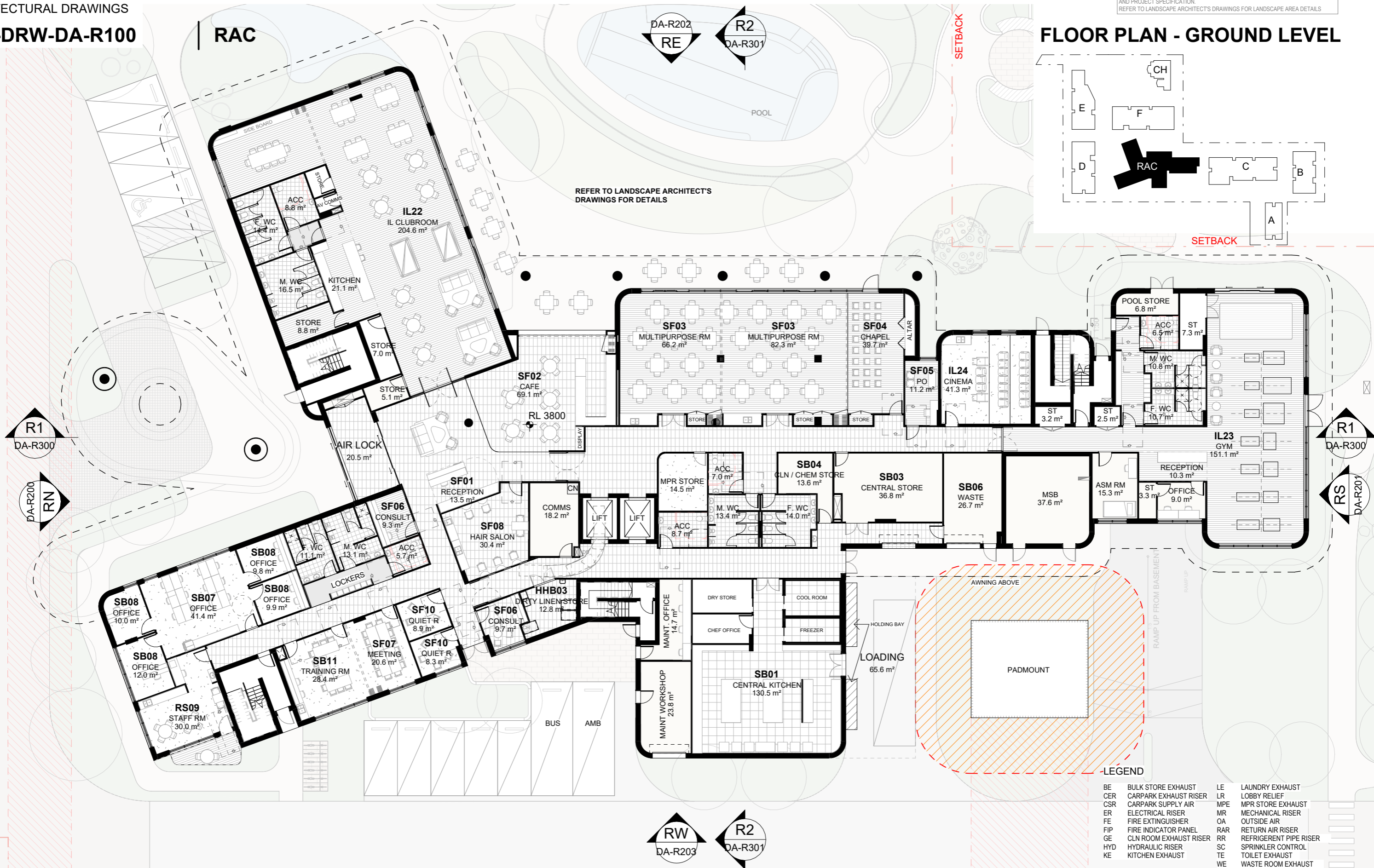

LEGEND

BE	BULK STORE EXHAUST	LE	LAUNDRY EXHAUST
CER	CARPARK EXHAUST RISER	LR	LOBBY RELIEF
CSR	CARPARK SUPPLY AIR	MPE	MPR STORE EXHAUST
ER	ELECTRICAL RISER	MR	MECHANICAL RISER
FE	FIRE EXTINGUISHER	OA	OUTSIDE AIR
FIP	FIRE INDICATOR PANEL	RAR	RETURN AIR RISER
GE	CLN ROOM EXHAUST RISER	RR	REFRIGERANT PIPE RISER
HYD	HYDRAULIC RISER	SC	SPRINKLER CONTROL
KE	KITCHEN EXHAUST	TE	TOILET EXHAUST
		WE	WASTE ROOM EXHAUST

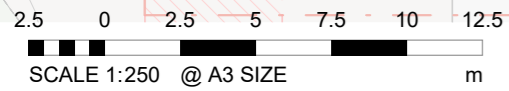

ISSUE A
Date of Issue | 31.01.2024

70303 | UNITING CARE | 24A KINGSCLIFF STREET, KINGSCLIFF, NSW 2487

DATE	DESCRIPTION	BY	CHK	REV
31.01.2024	FOR DA SUBMISSION	VP	CLIENT & CST	A

DISCLAIMER
In accepting and utilising this document the recipient agrees that Plus Architecture Pty. Ltd. ACN 091 690 336, retain all common law, statutory law and other rights including copyright and intellectual property rights. The recipient agrees not to use this document for any purpose other than its intended use; to waive all claims against Plus Architecture resulting from unauthorised changes; or to reuse the document on other projects without the prior written consent of Plus Architecture. Under no circumstances shall transfer of this document be deemed a sale. Plus Architecture makes no warranties of fitness for any purpose. The Builder/Contractor shall verify job dimensions prior to any work commencing. Figured dimensions shall take precedence over scaled work.



NOMINATED ARCHITECTS NSW - Amit Julka 10002, Rido Pin 11286
Level 4, 222 Clarence Street
Sydney NSW 2000
sydney@plusarchitecture.com.au
www.plusarchitecture.com.au
TELEPHONE +61 2 8823 7000
Plus Architecture Sydney Pty Ltd
ACN 618393338

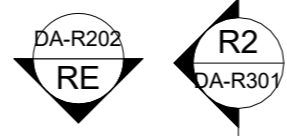

SETBACK

FLOOR PLAN - LEVEL 01

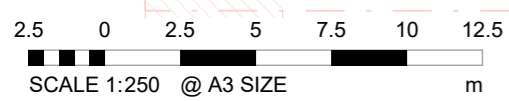
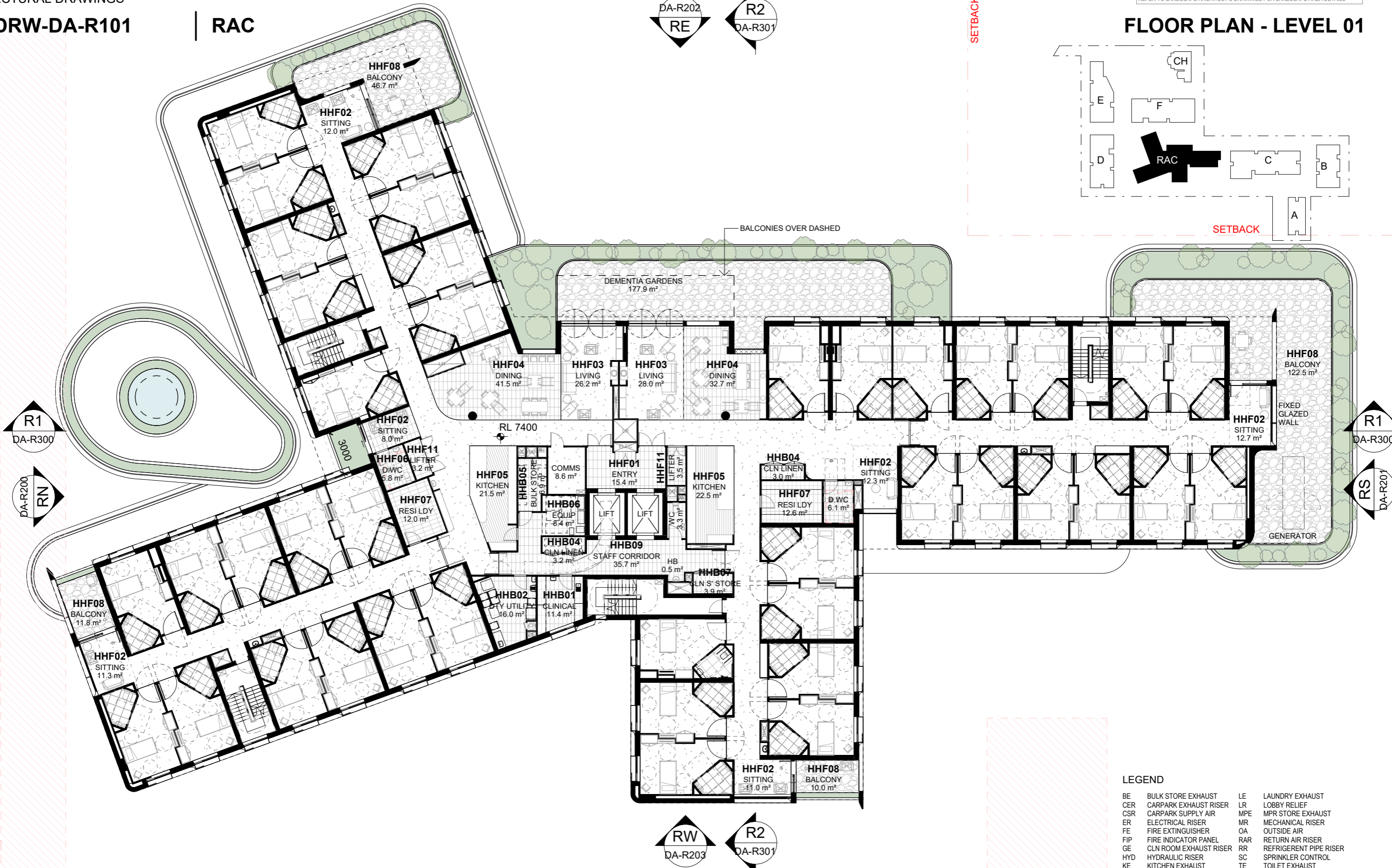
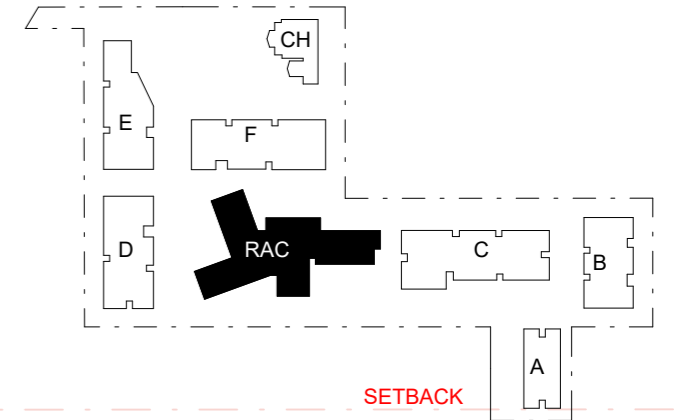

SETBACK

DATE	DESCRIPTION	BY	CHK	REV
31.01.2024	FOR DA SUBMISSION	VP	CLIENT & CST	A

DISCLAIMER
 In accepting and utilising this document the recipient agrees that Plus Architecture Pty. Ltd. ACN 091 690 336, retain all common law, statutory law and other rights including copyright and intellectual property rights. The recipient agrees not to use this document for any purpose other than its intended use; to waive all claims against Plus Architecture resulting from unauthorised changes; or to reuse the document on other projects without the prior written consent of Plus Architecture. Under no circumstances shall transfer of this document be deemed a sale. Plus Architecture makes no warranties of fitness for any purpose. The Builder/Contractor shall verify job dimensions prior to any work commencing. Figured dimensions shall take precedence over scaled work.



LEGEND

BE	BULK STORE EXHAUST	LE	LAUNDRY EXHAUST
CER	CARPARK EXHAUST RISER	LR	LOBBY RELIEF
CSR	CARPARK SUPPLY AIR	MPE	MPR STORE EXHAUST
ER	ELECTRICAL RISER	MR	MECHANICAL RISER
FE	FIRE EXTINGUISHER	OA	OUTSIDE AIR
FIP	FIRE INDICATOR PANEL	RAR	RETURN AIR RISER
GE	CLN ROOM EXHAUST RISER	RR	REFRIGERENT PIPE RISER
HYD	HYDRAULIC RISER	SC	SPRINKLER CONTROL
KE	KITCHEN EXHAUST	TE	TOILET EXHAUST
		WE	WASTE ROOM EXHAUST

NOMINATED ARCHITECTS NSW - Amit Julka 10002; Rido Pin 11286
 Level 4, 222 Clarence Street
 Sydney NSW 2000
 sydney@plusarchitecture.com.au
 www.plusarchitecture.com.au
 TELEPHONE +61 2 8823 7000
 Plus Architecture Sydney Pty Ltd
 ACN 618393338

ISSUE A
 Date of Issue | 31.01.2024

70303 | UNITING CARE | 24A KINGSCLIFF STREET, KINGSCLIFF, NSW 2487

JANUARY 2024 | DEVELOPMENT APPLICATION | PLUS ARCHITECTURE

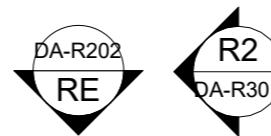

DRAWING TO BE READ IN CONJUNCTION WITH A0000 LEGEND, RELEVANT SCHEDULES AND PROJECT SPECIFICATION. REFER TO LANDSCAPE ARCHITECT'S DRAWINGS FOR LANDSCAPE AREA DETAILS

FLOOR PLAN - LEVEL 02

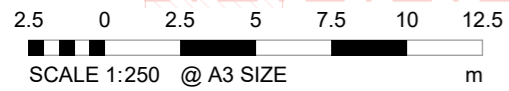
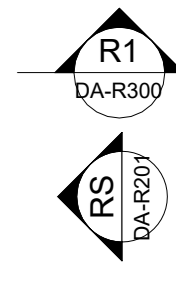
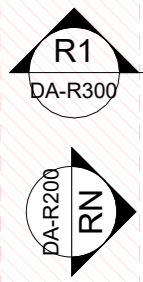
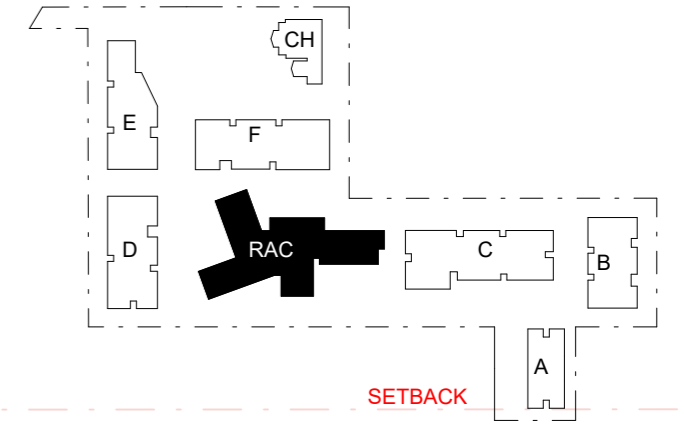

ISSUE A
Date of Issue | 31.01.2024

70303 | UNITING CARE | 24A KINGSCLIFF STREET, KINGSCLIFF, NSW 2487

DATE	DESCRIPTION	BY	CHK	REV
31.01.2024	FOR DA SUBMISSION	VP	CLIENT & CST	A

DISCLAIMER
In accepting and utilising this document the recipient agrees that Plus Architecture Pty. Ltd. ACN 091 690 336, retain all common law, statutory law and other rights including copyright and intellectual property rights. The recipient agrees not to use this document for any purpose other than its intended use, to waive all claims against Plus Architecture resulting from unauthorised changes; or to reuse the document on other projects without the prior written consent of Plus Architecture. Under no circumstances shall transfer of this document be deemed a sale. Plus Architecture makes no warranties of fitness for any purpose. The Builder/Contractor shall verify job dimensions prior to any work commencing. Figured dimensions shall take precedence over scaled work.



LEGEND

BE	BULK STORE EXHAUST	LE	LAUNDRY EXHAUST
CER	CARPARK EXHAUST RISER	LR	LOBBY RELIEF
CSR	CARPARK SUPPLY AIR	MPE	MPR STORE EXHAUST
ER	ELECTRICAL RISER	MR	MECHANICAL RISER
FE	FIRE EXTINGUISHER	OA	OUTSIDE AIR
FIP	FIRE INDICATOR PANEL	RAR	RETURN AIR RISER
GE	CLN ROOM EXHAUST RISER	RR	REFRIGERENT PIPE RISER
HYD	HYDRAULIC RISER	SC	SPRINKLER CONTROL
KE	KITCHEN EXHAUST	TE	TOILET EXHAUST
		WE	WASTE ROOM EXHAUST

NOMINATED ARCHITECTS NSW - Amit Julka 10002, Rido Pin 11286
 Level 4, 222 Clarence Street
 Sydney NSW 2000
 sydney@plusarchitecture.com.au
 www.plusarchitecture.com.au
 TELEPHONE +61 2 8823 7000
 Plus Architecture Sydney Pty Ltd
 ACN 618393338

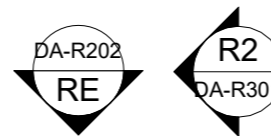

DRAWING TO BE READ IN CONJUNCTION WITH A0000 LEGEND, RELEVANT SCHEDULES AND PROJECT SPECIFICATION. REFER TO LANDSCAPE ARCHITECT'S DRAWINGS FOR LANDSCAPE AREA DETAILS

FLOOR PLAN - LEVEL 03

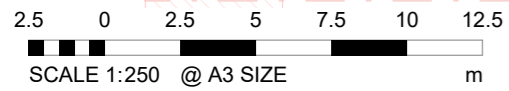
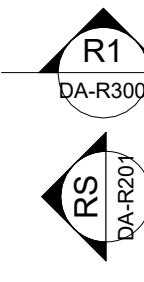
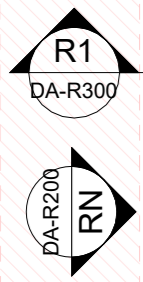
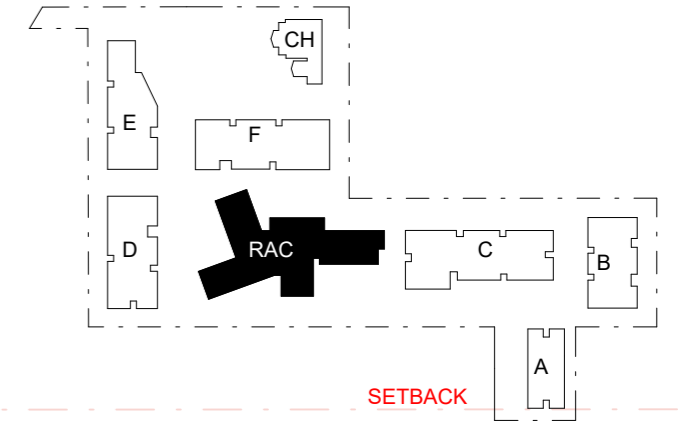

SETBACK

DATE	DESCRIPTION	BY	CHK	REV
31.01.2024	FOR DA SUBMISSION	VP	CLIENT & CST	A

DISCLAIMER
 In accepting and utilising this document the recipient agrees that Plus Architecture Pty. Ltd. ACN 091 690 336, retain all common law, statutory law and other rights including copyright and intellectual property rights. The recipient agrees not to use this document for any purpose other than its intended use; to waive all claims against Plus Architecture resulting from unauthorised changes; or to reuse the document on other projects without the prior written consent of Plus Architecture. Under no circumstances shall transfer of this document be deemed a sale. Plus Architecture makes no warranties of fitness for any purpose. The Builder/Contractor shall verify job dimensions prior to any work commencing. Figured dimensions shall take precedence over scaled work.



LEGEND

BE	BULK STORE EXHAUST	LE	LAUNDRY EXHAUST
CER	CARPARK EXHAUST RISER	LR	LOBBY RELIEF
CSR	CARPARK SUPPLY AIR	MPE	MPR STORE EXHAUST
ER	ELECTRICAL RISER	MR	MECHANICAL RISER
FE	FIRE EXTINGUISHER	OA	OUTSIDE AIR
FIP	FIRE INDICATOR PANEL	RAR	RETURN AIR RISER
GE	CLN ROOM EXHAUST RISER	RR	REFRIGERENT PIPE RISER
HYD	HYDRAULIC RISER	SC	SPRINKLER CONTROL
KE	KITCHEN EXHAUST	TE	TOILET EXHAUST
		WE	WASTE ROOM EXHAUST

NOMINATED ARCHITECTS NSW - Amit Julka 10002, Rido Pin 11286
 Level 4, 222 Clarence Street
 Sydney NSW 2000
 sydney@plusarchitecture.com.au
 www.plusarchitecture.com.au
 TELEPHONE +61 2 8823 7000
 Plus Architecture Sydney Pty Ltd
 ACN 618393338

ISSUE A
 Date of Issue | 31.01.2024

70303 | UNITING CARE | 24A KINGSCLIFF STREET, KINGSCLIFF, NSW 2487

JANUARY 2024 | DEVELOPMENT APPLICATION | PLUS ARCHITECTURE

ROOF PLAN

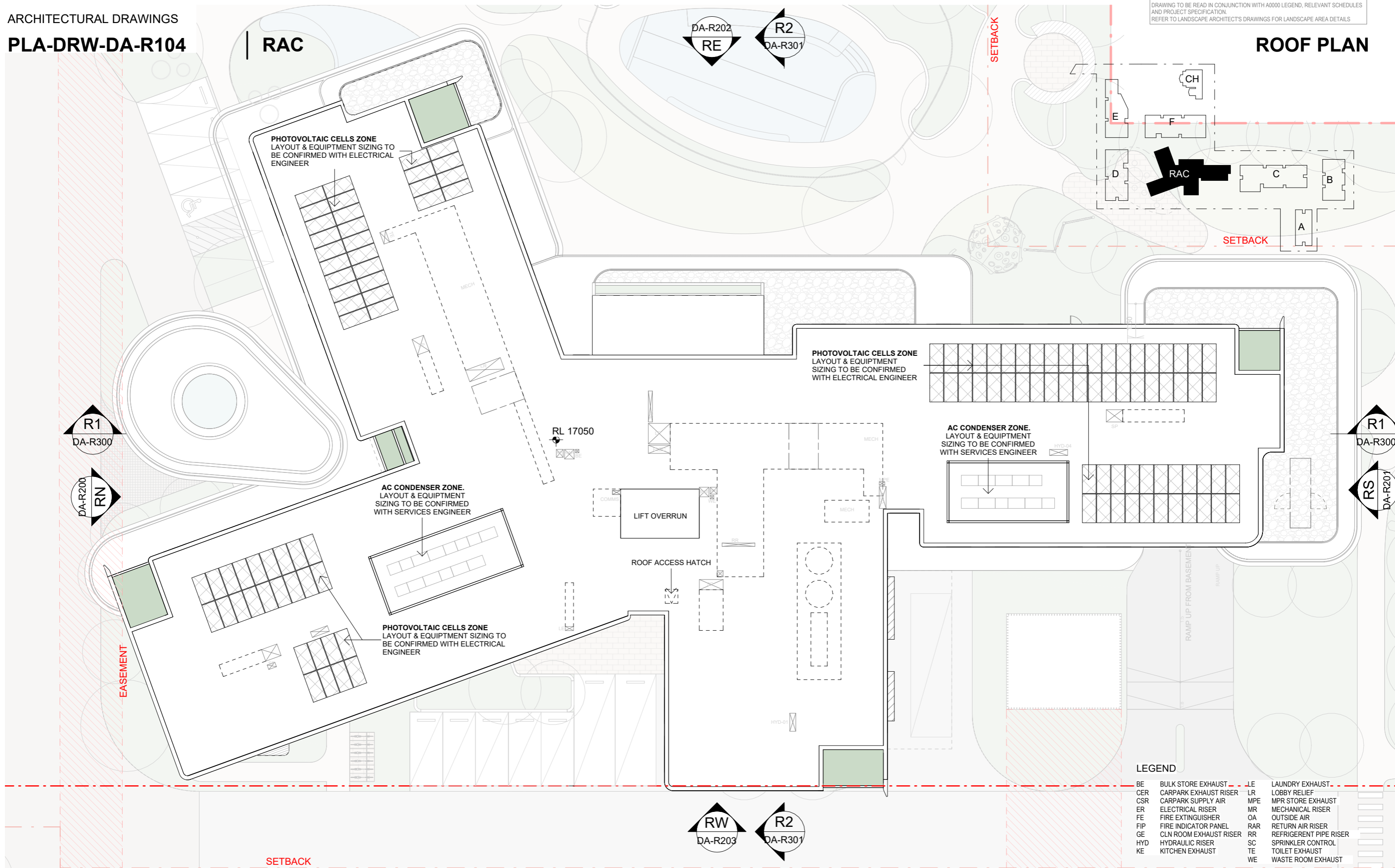

LEGEND

BE	BULK STORE EXHAUST	LE	LAUNDRY EXHAUST
CER	CARPARK EXHAUST RISER	LR	LOBBY RELIEF
CSR	CARPARK SUPPLY AIR	MPE	MPR STORE EXHAUST
ER	ELECTRICAL RISER	MR	MECHANICAL RISER
FE	FIRE EXTINGUISHER	OA	OUTSIDE AIR
FIP	FIRE INDICATOR PANEL	RAR	RETURN AIR RISER
GE	CLN ROOM EXHAUST RISER	RR	REFRIGERENT PIPE RISER
HYD	HYDRAULIC RISER	SC	SPRINKLER CONTROL
KE	KITCHEN EXHAUST	TE	TOILET EXHAUST
		WE	WASTE ROOM EXHAUST

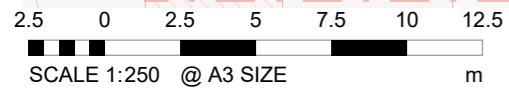

DATE	DESCRIPTION	BY	CHK	REV
31.01.2024	FOR DA SUBMISSION	VP	CLIENT & CST	A

DISCLAIMER
 In accepting and utilising this document the recipient agrees that Plus Architecture Pty. Ltd. ACN 091 690 336, retain all common law, statutory law and other rights including copyright and intellectual property rights. The recipient agrees not to use this document for any purpose other than its intended use; to waive all claims against Plus Architecture resulting from unauthorised changes; or to reuse the document on other projects without the prior written consent of Plus Architecture. Under no circumstances shall transfer of this document be deemed a sale. Plus Architecture makes no warranties of fitness for any purpose. The Builder/Contractor shall verify job dimensions prior to any work commencing. Figured dimensions shall take precedence over scaled work.



NOMINATED ARCHITECTS NSW - Amit Julka 10002; Rido Pin 11286
 Level 4, 222 Clarence Street
 Sydney NSW 2000
 sydney@plusarchitecture.com.au
 www.plusarchitecture.com.au
 TELEPHONE +61 2 8823 7000
 Plus Architecture Sydney Pty Ltd
 ACN 618393338

ISSUE A
 Date of Issue | 31.01.2024

70303 | UNITING CARE | 24A KINGSCLIFF STREET, KINGSCLIFF, NSW 2487

JANUARY 2024 | DEVELOPMENT APPLICATION | PLUS ARCHITECTURE

BUILDING ELEVATION - NORTH

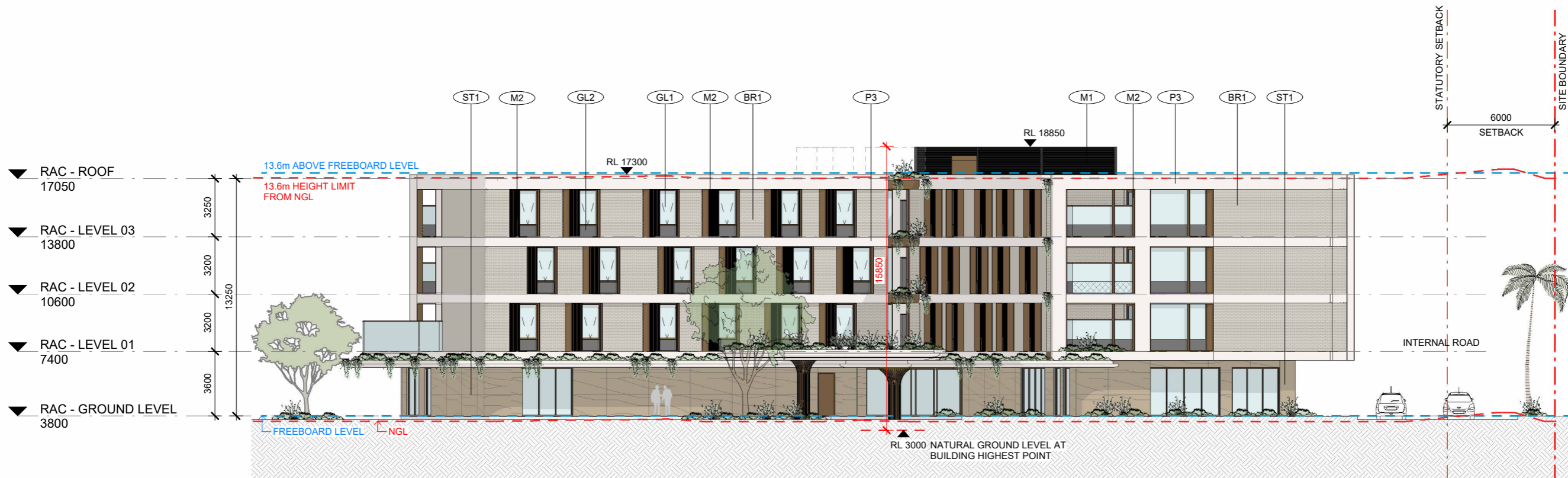
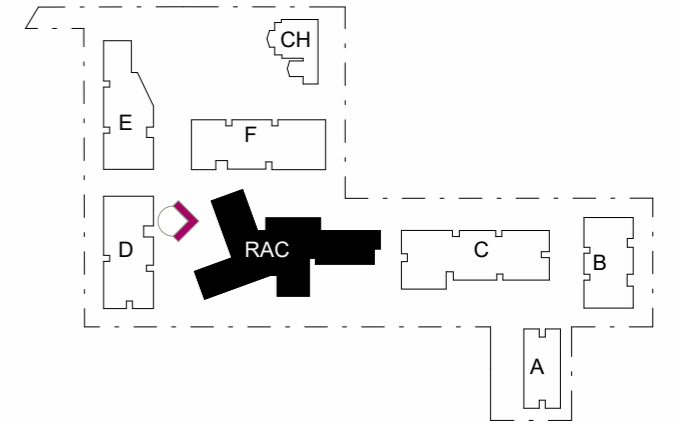

EXTERNAL FINISHES LEGEND

- BR1 BRICK TYPE 1
- BR2 BRICK TYPE 2
- BR3 BRICK TYPE 3
- BR4 BRICK TYPE 4
- GL1 GLAZING
- GL2 FRITTED GLAZING
- M1 METAL FINISH - CHARCOAL
- M2 METAL FINISH - BRONZE
- M3 METAL CLADDING - CHARCOAL
- M4 METAL CLADDING - GREY
- M5 METAL CLADDING - BRONZE
- P1 PAINT FINISH - DARK CHARCOAL
- P2 PAINT FINISH - GREY
- P3 PAINT FINISH - OFF WHITE
- P4 PAINT FINISH - TO MATCH M2
- P5 PAINT FINISH - OFF WHITE
- ST1 VERTICAL SCORING
- PRE-FINISHED FC CLADDING

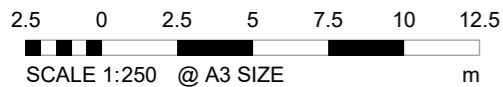

ISSUE A
Date of Issue | 16.02.2024

70303 | UNITING CARE | 24A KINGSCLIFF STREET, KINGSCLIFF, NSW 2487

DATE	DESCRIPTION	BY	CHK	REV
16.02.2024	FOR DA SUBMISSION	VP	CLIENT & CST	A

DISCLAIMER
In accepting and utilising this document the recipient agrees that Plus Architecture Pty. Ltd. ACN 091 690 336, retain all common law, statutory law and other rights including copyright and intellectual property rights. The recipient agrees not to use this document for any purpose other than its intended use; to waive all claims against Plus Architecture resulting from unauthorised changes; or to reuse the document on other projects without the prior written consent of Plus Architecture. Under no circumstances shall transfer of this document be deemed a sale. Plus Architecture makes no warranties of fitness for any purpose. The Builder/Contractor shall verify job dimensions prior to any work commencing. Figured dimensions shall take precedence over scaled work.



NOMINATED ARCHITECTS NSW - Amit Julka 10002; Rido Pin 11286
Level 4, 222 Clarence Street TELEPHONE +61 2 8823 7000
Sydney NSW 2000 Plus Architecture Sydney Pty Ltd
sydney@plusarchitecture.com.au www.plusarchitecture.com.au ACN 618393338

BUILDING ELEVATION - SOUTH

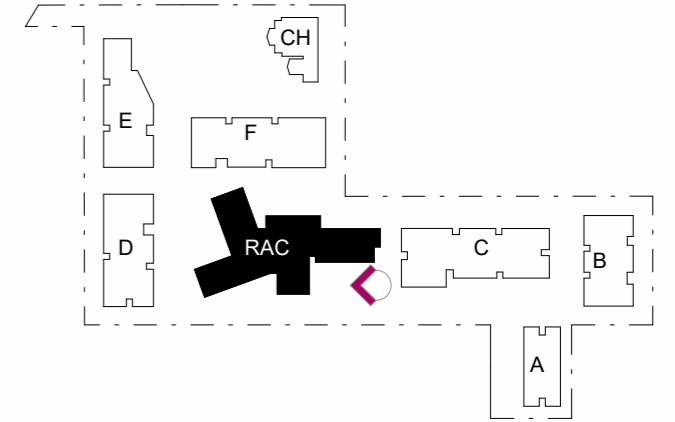

- BR1 BRICK TYPE 1
- BR2 BRICK TYPE 2
- BR3 BRICK TYPE 3
- BR4 BRICK TYPE 4
- GL1 GLAZING
- GL2 FRITTED GLAZING
- M1 METAL FINISH - CHARCOAL
- M2 METAL FINISH - BRONZE
- M3 METAL CLADDING - CHARCOAL
- M4 METAL CLADDING - GREY
- M5 METAL CLADDING - BRONZE
- P1 PAINT FINISH - DARK CHARCOAL
- P2 PAINT FINISH - GREY
- P3 PAINT FINISH - OFF WHITE
- P4 PAINT FINISH - TO MATCH M2
- P5 PAINT FINISH - OFF WHITE
- ST1 VERTICAL SCORING
- PRE-FINISHED FC CLADDING

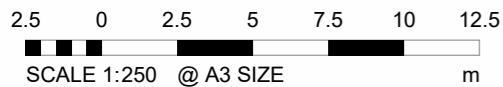

ISSUE A
Date of Issue | 16.02.2024

DATE	DESCRIPTION	BY	CHK	REV
16.02.2024	FOR DA SUBMISSION	VP	CLIENT & CST	A

DISCLAIMER
In accepting and utilising this document the recipient agrees that Plus Architecture Pty. Ltd. ACN 091 690 336, retain all common law, statutory law and other rights including copyright and intellectual property rights. The recipient agrees not to use this document for any purpose other than its intended use; to waive all claims against Plus Architecture resulting from unauthorised changes; or to reuse the document on other projects without the prior written consent of Plus Architecture. Under no circumstances shall transfer of this document be deemed a sale. Plus Architecture makes no warranties of fitness for any purpose. The Builder/Contractor shall verify job dimensions prior to any work commencing. Figured dimensions shall take precedence over scaled work.



NOMINATED ARCHITECTS NSW - Amit Julka 10002; Rido Pin 11286
 Level 4, 222 Clarence Street TELEPHONE +61 2 8823 7000
 Sydney NSW 2000 Plus Architecture Sydney Pty Ltd
 sydney@plusarchitecture.com.au www.plusarchitecture.com.au ACN 618393338

BUILDING ELEVATION - EAST

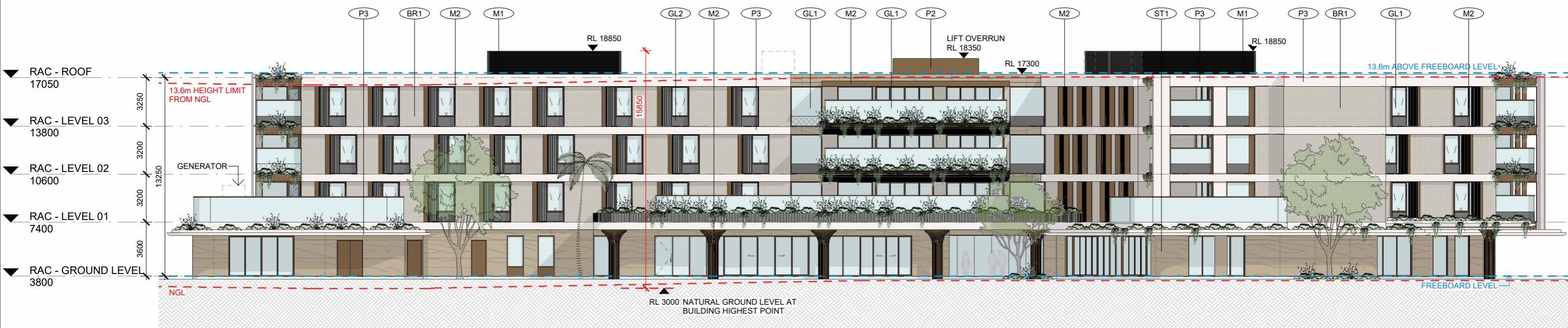
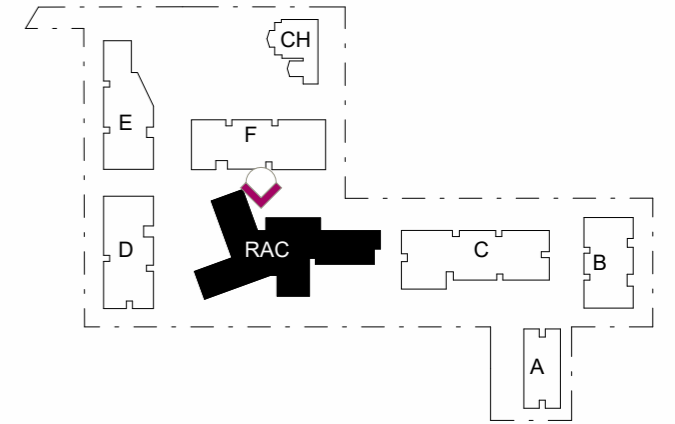

EXTERNAL FINISHES LEGEND

- BR1 BRICK TYPE 1
- BR2 BRICK TYPE 2
- BR3 BRICK TYPE 3
- BR4 BRICK TYPE 4
- GL1 GLAZING
- GL2 FRITTED GLAZING
- M1 METAL FINISH - CHARCOAL
- M2 METAL FINISH - BRONZE
- M3 METAL CLADDING - CHARCOAL
- M4 METAL CLADDING - GREY
- M5 METAL CLADDING - BRONZE
- P1 PAINT FINISH - DARK CHARCOAL
- P2 PAINT FINISH - GREY
- P3 PAINT FINISH - OFF WHITE
- P4 PAINT FINISH - TO MATCH M2
- P5 PAINT FINISH - OFF WHITE
- ST1 VERTICAL SCORING
- PRE-FINISHED FC CLADDING

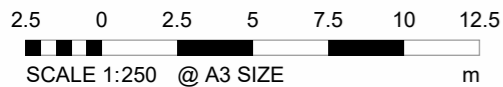

ISSUE A
Date of Issue | 16.02.2024

DATE	DESCRIPTION	BY	CHK	REV
16.02.2024	FOR DA SUBMISSION	VP	CLIENT & CST	A

DISCLAIMER
In accepting and utilising this document the recipient agrees that Plus Architecture Pty. Ltd. ACN 091 690 336, retain all common law, statutory law and other rights including copyright and intellectual property rights. The recipient agrees not to use this document for any purpose other than its intended use; to waive all claims against Plus Architecture resulting from unauthorised changes; or to reuse the document on other projects without the prior written consent of Plus Architecture. Under no circumstances shall transfer of this document be deemed a sale. Plus Architecture makes no warranties of fitness for any purpose. The Builder/Contractor shall verify job dimensions prior to any work commencing. Figured dimensions shall take precedence over scaled work.



NOMINATED ARCHITECTS NSW - Amit Julka 10002; Rido Pin 11286
Level 4, 222 Clarence Street TELEPHONE +61 2 8823 7000
Sydney NSW 2000 Plus Architecture Sydney Pty Ltd
sydney@plusarchitecture.com.au www.plusarchitecture.com.au ACN 618393338

BUILDING ELEVATION - WEST

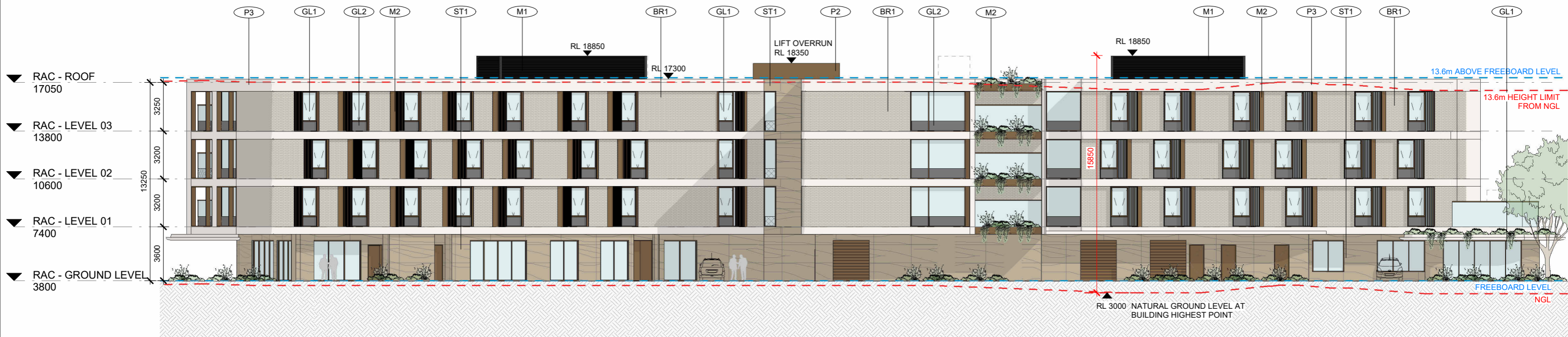
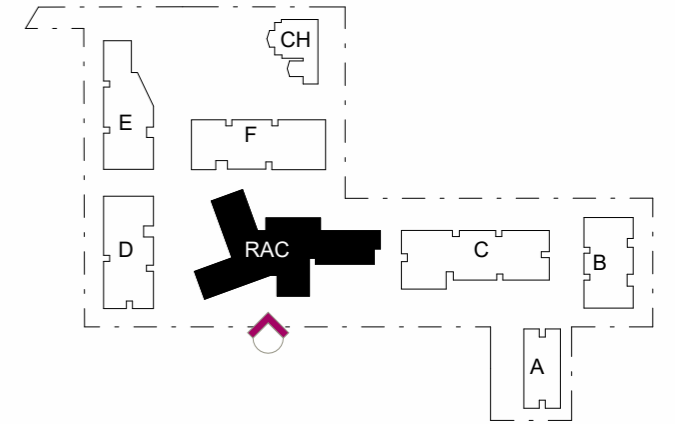

EXTERNAL FINISHES LEGEND

- BR1 BRICK TYPE 1
- BR2 BRICK TYPE 2
- BR3 BRICK TYPE 3
- BR4 BRICK TYPE 4
- GL1 GLAZING
- GL2 FRITTED GLAZING
- M1 METAL FINISH - CHARCOAL
- M2 METAL FINISH - BRONZE
- M3 METAL CLADDING - CHARCOAL
- M4 METAL CLADDING - GREY
- M5 METAL CLADDING - BRONZE
- P1 PAINT FINISH - DARK CHARCOAL
- P2 PAINT FINISH - GREY
- P3 PAINT FINISH - OFF WHITE
- P4 PAINT FINISH - TO MATCH M2
- P5 PAINT FINISH - OFF WHITE
- ST1 VERTICAL SCORING
- PRE-FINISHED FC CLADDING

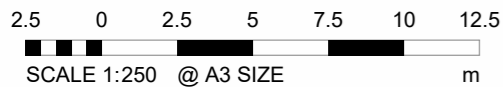

ISSUE A
Date of Issue | 16.02.2024

70303 | UNITING CARE | 24A KINGSCLIFF STREET, KINGSCLIFF, NSW 2487

DATE	DESCRIPTION	BY	CHK	REV
16.02.2024	FOR DA SUBMISSION	VP	CLIENT & CST	A

DISCLAIMER
In accepting and utilising this document the recipient agrees that Plus Architecture Pty. Ltd. ACN 091 690 336, retain all common law, statutory law and other rights including copyright and intellectual property rights. The recipient agrees not to use this document for any purpose other than its intended use; to waive all claims against Plus Architecture resulting from unauthorised changes; or to reuse the document on other projects without the prior written consent of Plus Architecture. Under no circumstances shall transfer of this document be deemed a sale. Plus Architecture makes no warranties of fitness for any purpose. The Builder/Contractor shall verify job dimensions prior to any work commencing. Figured dimensions shall take precedence over scaled work.



NOMINATED ARCHITECTS NSW - Amit Julka 10002; Rido Pin 11286
Level 4, 222 Clarence Street TELEPHONE +61 2 8823 7000
Sydney NSW 2000 Plus Architecture Sydney Pty Ltd
sydney@plusarchitecture.com.au www.plusarchitecture.com.au ACN 618393338

BUILDING SECTION R1

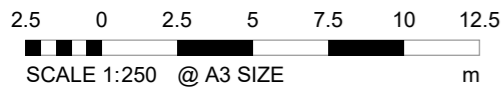
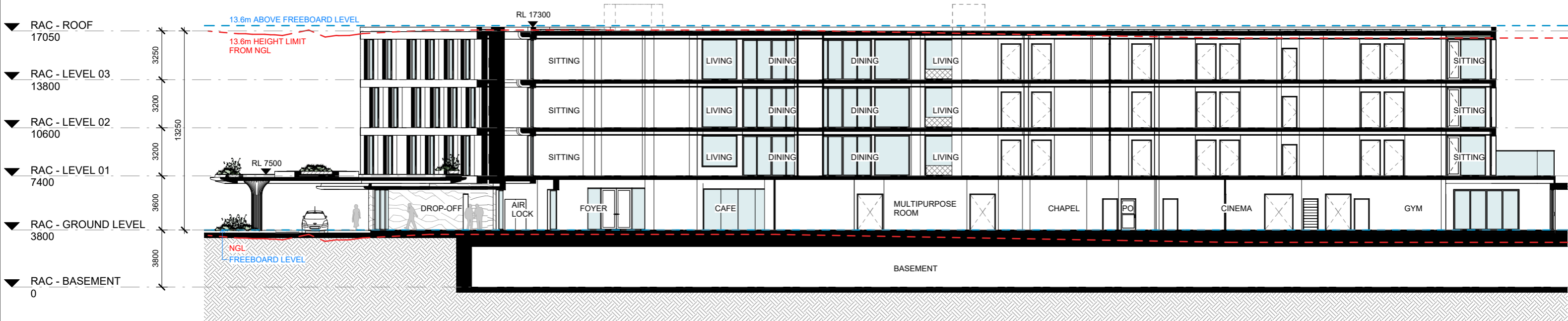
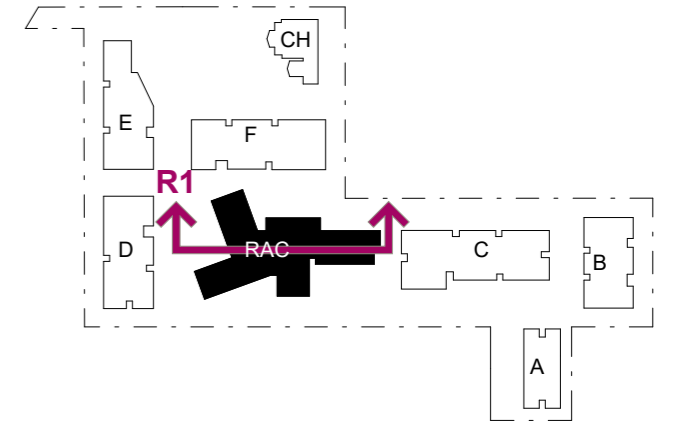

ISSUE A
Date of Issue | 16.02.2024

70303 | UNITING CARE | 24A KINGSCLIFF STREET, KINGSCLIFF, NSW 2487

DATE	DESCRIPTION	BY	CHK	REV
16.02.2024	FOR DA SUBMISSION	VP	CLIENT & CST	A

DISCLAIMER
In accepting and utilising this document the recipient agrees that Plus Architecture Pty. Ltd. ACN 091 690 336, retain all common law, statutory law and other rights including copyright and intellectual property rights. The recipient agrees not to use this document for any purpose other than its intended use; to waive all claims against Plus Architecture resulting from unauthorised changes; or to reuse the document on other projects without the prior written consent of Plus Architecture. Under no circumstances shall transfer of this document be deemed a sale. Plus Architecture makes no warranties of fitness for any purpose. The Builder/Contractor shall verify job dimensions prior to any work commencing. Figured dimensions shall take precedence over scaled work.



NOMINATED ARCHITECTS NSW - Amit Julka 10002; Rido Pin 11286
Level 4, 222 Clarence Street
Sydney NSW 2000
sydney@plusarchitecture.com.au
www.plusarchitecture.com.au
TELEPHONE +61 2 8823 7000
Plus Architecture Sydney Pty Ltd
ACN 618393338

BUILDING SECTION R2

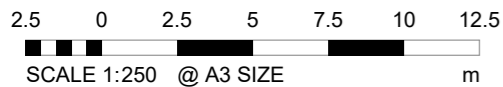
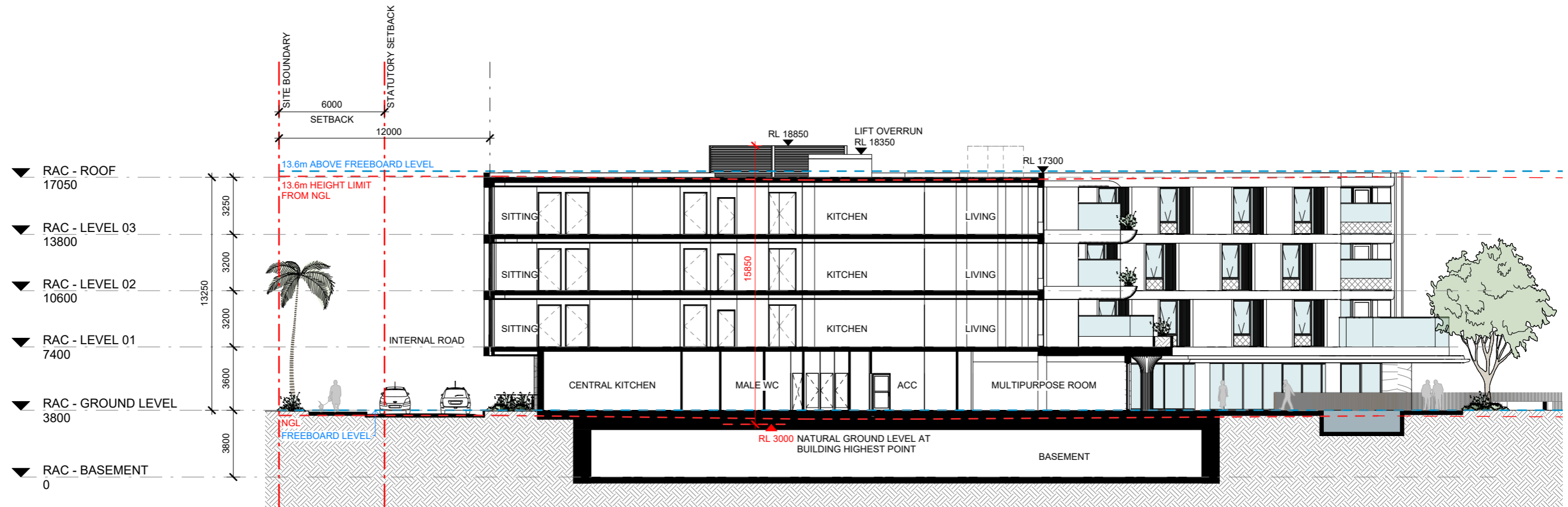
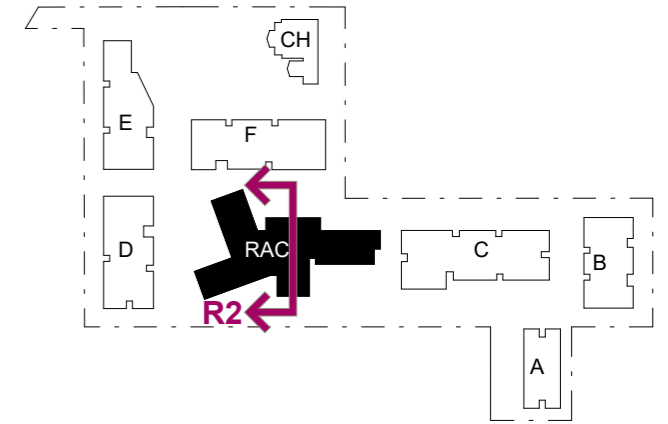

ISSUE A
Date of Issue | 16.02.2024

70303 | UNITING CARE | 24A KINGSCLIFF STREET, KINGSCLIFF, NSW 2487

DATE	DESCRIPTION	BY	CHK	REV
16.02.2024	FOR DA SUBMISSION	VP	CLIENT & CST	A

DISCLAIMER
 In accepting and utilising this document the recipient agrees that Plus Architecture Pty. Ltd. ACN 091 690 336, retain all common law, statutory law and other rights including copyright and intellectual property rights. The recipient agrees not to use this document for any purpose other than its intended use; to waive all claims against Plus Architecture resulting from unauthorised changes; or to reuse the document on other projects without the prior written consent of Plus Architecture. Under no circumstances shall transfer of this document be deemed a sale. Plus Architecture makes no warranties of fitness for any purpose. The Builder/Contractor shall verify job dimensions prior to any work commencing. Figured dimensions shall take precedence over scaled work.



NOMINATED ARCHITECTS NSW - Amit Julka 10002; Rido Pin 11286
 Level 4, 222 Clarence Street TELEPHONE +61 2 8823 7000
 Sydney NSW 2000
 sydney@plusarchitecture.com.au Plus Architecture Sydney Pty Ltd
 www.plusarchitecture.com.au ACN 618393338

GFA DIAGRAMS

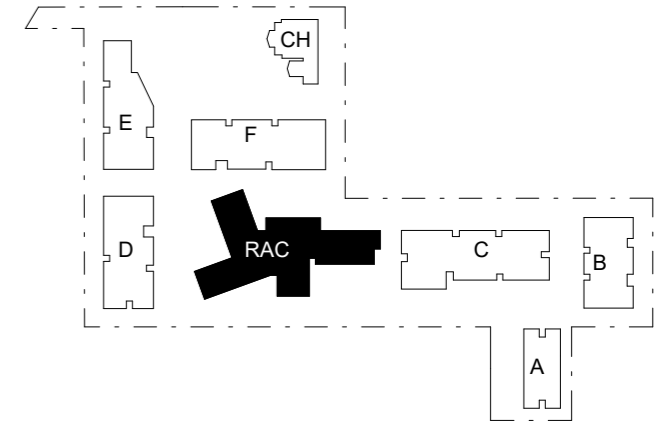
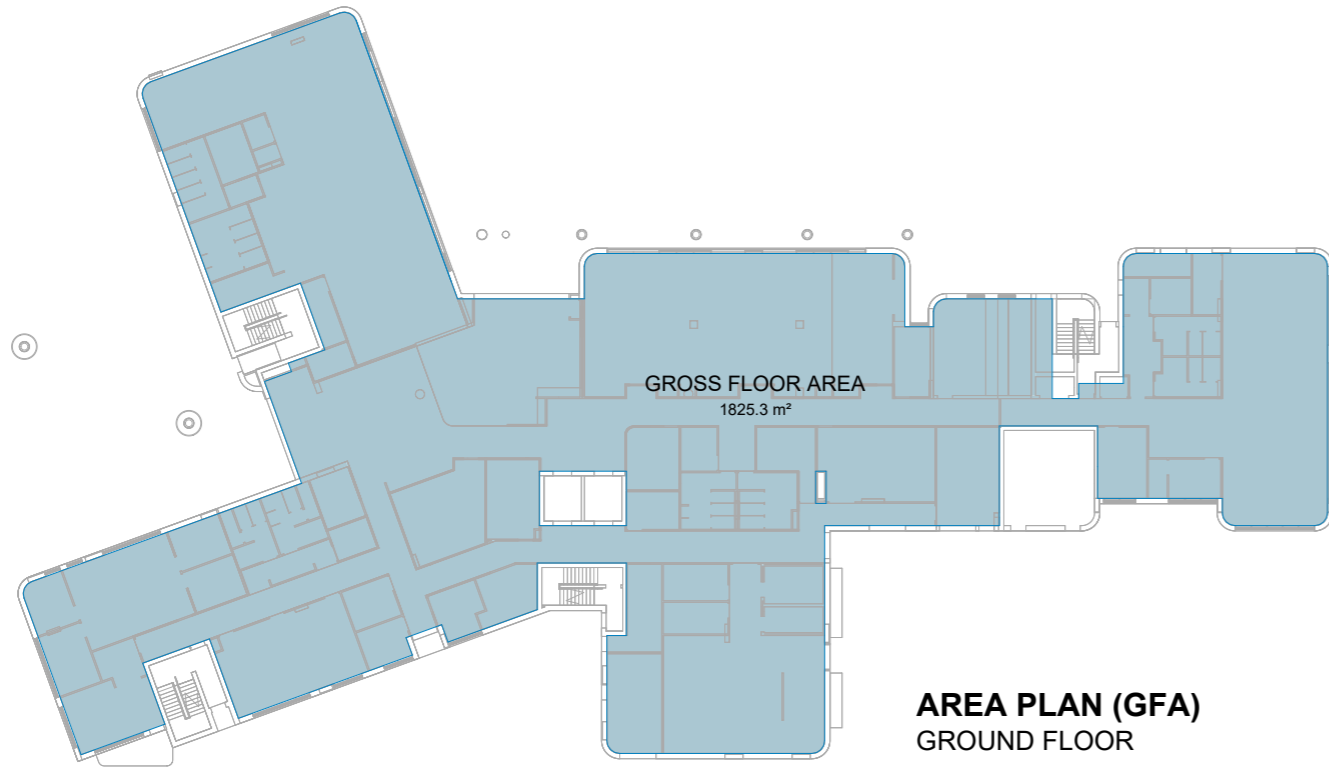

RAC - GROUND LEVEL	1825.3 m ²
RAC - LEVEL 01	1756.3 m ²
RAC - LEVEL 02	1756.3 m ²
RAC - LEVEL 03	1756.3 m ²
TOTAL GROSS FLOOR AREA	7094.3 m²

LEGENDS
 GFA

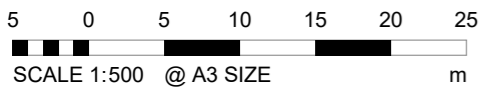
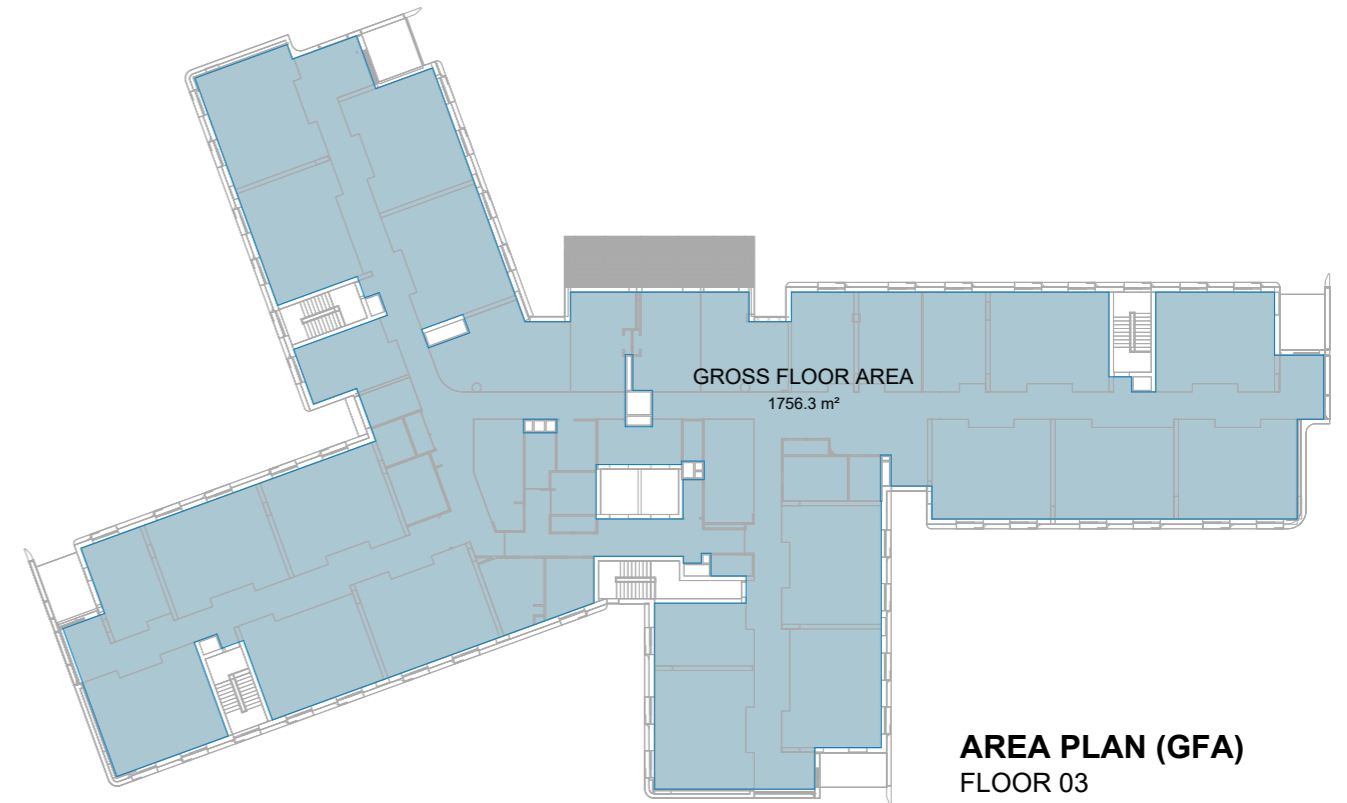
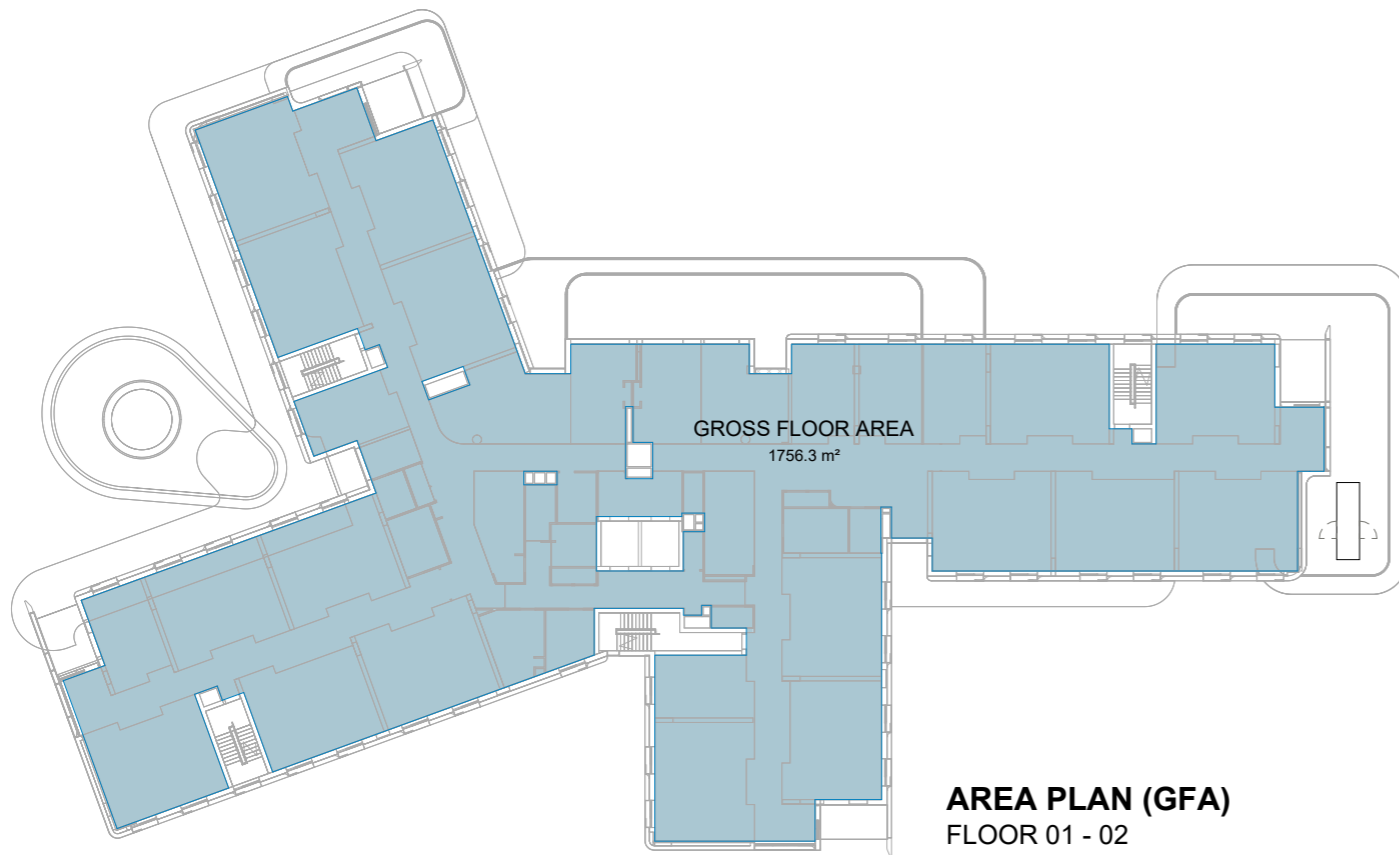

DATE	DESCRIPTION	BY	CHK	REV
31.01.2024	FOR DA SUBMISSION	VP	CLIENT & CST	A

DISCLAIMER
 In accepting and utilising this document the recipient agrees that Plus Architecture Pty. Ltd. ACN 091 690 336, retain all common law, statutory law and other rights including copyright and intellectual property rights. The recipient agrees not to use this document for any purpose other than its intended use; to waive all claims against Plus Architecture resulting from unauthorised changes; or to reuse the document on other projects without the prior written consent of Plus Architecture. Under no circumstances shall transfer of this document be deemed a sale. Plus Architecture makes no warranties of fitness for any purpose. The Builder/Contractor shall verify job dimensions prior to any work commencing. Figured dimensions shall take precedence over scaled work.



NOMINATED ARCHITECTS NSW - Amit Julka 10002; Rido Pin 11286
 Level 4, 222 Clarence Street
 Sydney NSW 2000
 sydney@plusarchitecture.com.au
 www.plusarchitecture.com.au
 TELEPHONE +61 2 8823 7000
 Plus Architecture Sydney Pty Ltd
 ACN 618393338

ISSUE A
 Date of Issue | 31.01.2024

70303 | UNITING CARE | 24A KINGSCLIFF STREET, KINGSCLIFF, NSW 2487

JANUARY 2024 | DEVELOPMENT APPLICATION | PLUS ARCHITECTURE

SMOKE COMPARTMENTS

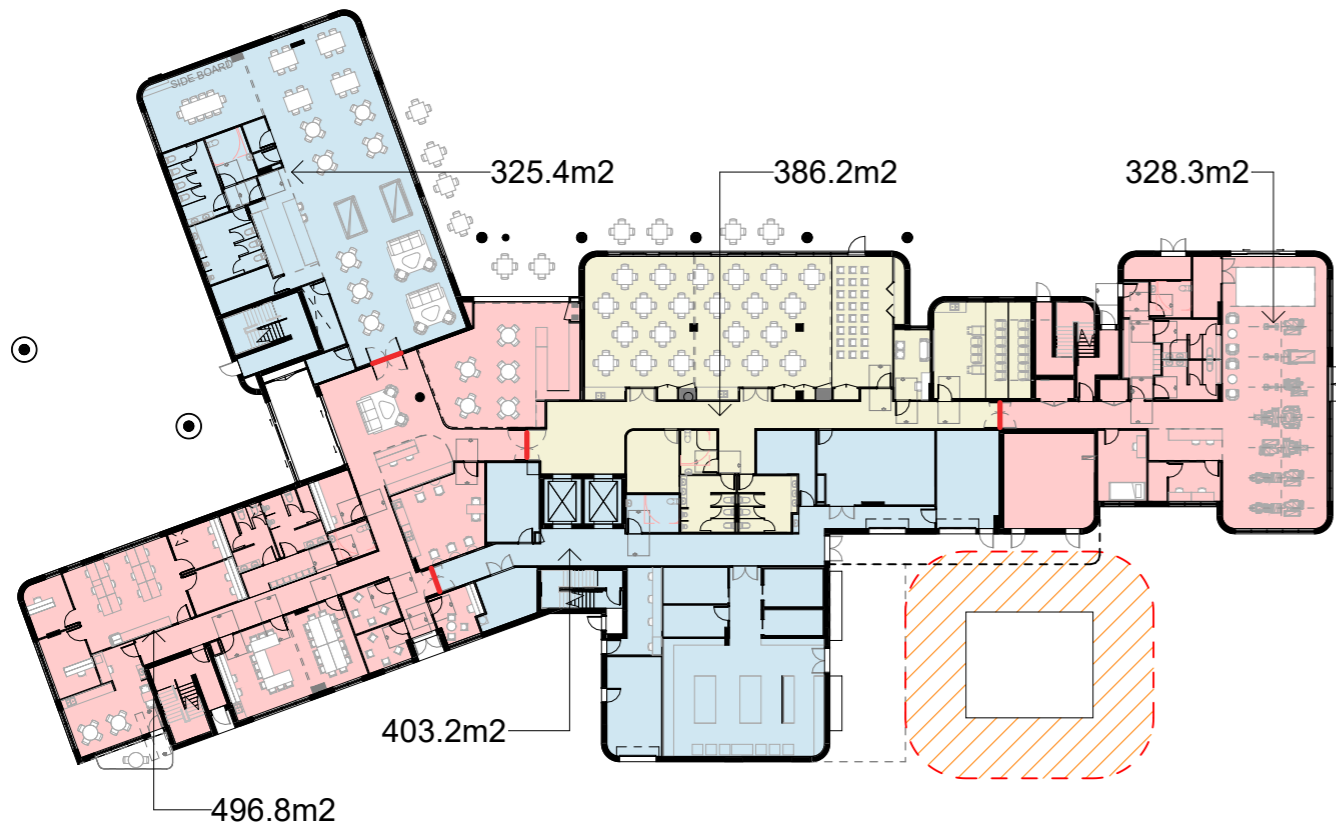
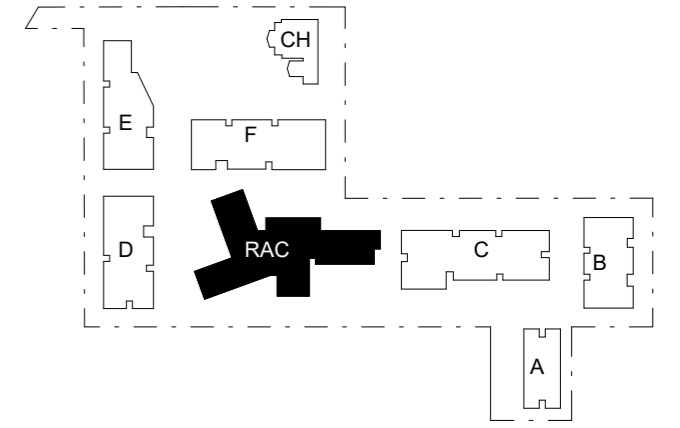

SMOKE COMPARTMENT PLAN
GROUND FLOOR



SMOKE COMPARTMENT PLAN
LEVELS 1-3

LEGEND
— SMOKE DOOR

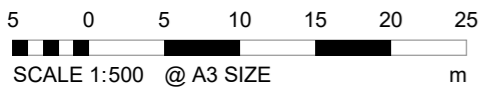

DATE	DESCRIPTION	BY	CHK	REV
31.01.2024	FOR DA SUBMISSION	VP	CLIENT & CST	A

DISCLAIMER
In accepting and utilising this document the recipient agrees that Plus Architecture Pty. Ltd. ACN 091 690 336, retain all common law, statutory law and other rights including copyright and intellectual property rights. The recipient agrees not to use this document for any purpose other than its intended use; to waive all claims against Plus Architecture resulting from unauthorised changes; or to reuse the document on other projects without the prior written consent of Plus Architecture. Under no circumstances shall transfer of this document be deemed a sale. Plus Architecture makes no warranties of fitness for any purpose. The Builder/Contractor shall verify job dimensions prior to any work commencing. Figured dimensions shall take precedence over scaled work.



NOMINATED ARCHITECTS NSW - Amit Julka 10002; Rido Pin 11286
 Level 4, 222 Clarence Street TELEPHONE +61 2 8823 7000
 Sydney NSW 2000 Plus Architecture Sydney Pty Ltd
 sydney@plusarchitecture.com.au www.plusarchitecture.com.au ACN 618393338

ISSUE A
Date of Issue | 31.01.2024

70303 | UNITING CARE | 24A KINGSCLIFF STREET, KINGSCLIFF, NSW 2487

PLUS ARCHITECTURE



CONSULTING