

Confidential

Kemps Creek Data Centre

Infrastructure Requirements Report

SYD05-06-07_C-R-0010

Revision 3 | 31 August 2021

This report takes into account the particular instructions and requirements of our client.











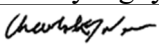

It is not intended for and should not be relied upon by any third party and no responsibility is undertaken to any third party.

Job number 277863-00

Arup Australia Pty Ltd ABN 76 625 912 665

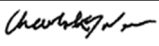
Arup
Level 5
151 Clarence Street
Sydney NSW 2000
Australia
www.arup.com



ARUP

Job title		Kemps Creek Data Centre		Job number		277863-00	
Document title		Infrastructure Requirements Report		File reference		SYD05-06-07_C-R-0010	
Document ref		SYD05-06-07_C-R-0010					
Revision	Date	Filename	SYD05-06-07_C-R-0010.docx				
Draft 1	21 January 2021	Description	Draft				
			Prepared by	Checked by	Approved by		
		Name	Charlotte Ware Thierry Melis Ashley Nguyen	Vlatko Stoilovski	Euan Mitchell		
		Signature	 				
Revision 1	19 March 2021	Filename	SYD05-06-07_C-R-0010.docx				
		Description	Final Issue				
			Prepared by	Checked by	Approved by		
		Name	Charlotte Ware Thierry Melis Ashley Nguyen	Vlatko Stoilovski	Euan Mitchell		
Signature	 						
Revision 2	16 April 2021	Filename	SYD05-06-07_C-R-0010				
		Description	Final Issue for Adequacy Review				
			Prepared by	Checked by	Approved by		
		Name	Charlotte Ware Thierry Melis Ashley Nguyen	Vlatko Stoilovski	Euan Mitchell		
Signature	 						

Issue Document verification with document



Document Verification

Job title		Kemps Creek Data Centre		Job number	
				277863-00	
Document title		Infrastructure Requirements Report		File reference	
Document ref		SYD05-06-07_C-R-0010			
Revision	Date	Filename	SYD05-06-07_C-R-0010.docx		
Revision 2	31 Aug 2021	Description	Final Issue		
			Prepared by	Checked by	Approved by
		Name	Ashley Nguyen	Euan Mitchell	Euan Mitchell
		Signature			
		Filename			
		Description			
			Prepared by	Checked by	Approved by
		Name			
		Signature			
		Filename			
		Description			
			Prepared by	Checked by	Approved by
		Name			
		Signature			
		Filename			
		Description			
			Prepared by	Checked by	Approved by
		Name			
		Signature			

Issue Document Verification with Document



Executive Summary

The subject site is legally defined as 757-769 Mamre Road, Kemps Creek and sits within a wider industrial estate under a concurrent State Significant Development (SSD) Application – SSD 9522. Following completion of the consented estate development works the subject site will comprise a benched earthworks platform with stormwater and utility connections from the estate to the site boundary.

No private or public utilities will be located within the subject site boundary following the consented estate development works. There is therefore no construction impact on existing publicly or privately owned utilities within the subject site.

The proposed data centre is a mission critical facility and therefore requires redundancy in its utility servicing including back up electrical generation, water storage tanks and separated telecommunication conduit routes. Construction of the data centre will be phased to suit market demand.

A temporary 22kV switching station will be provided at the site boundary to serve as a point of connection for initial stages of the data centre.

In the permanent arrangement, a 132kV switching station, owned by the Proponent, will be constructed and includes:

- 132kV switchgear for control of the incoming 132kV feeders, and protection and distribution to the 70MVA transformers
- 4 no. 70MVA 132/22kV transformers.
- 22kV switchgear to allow for protection, control, and distribution of power around the site via a 22kV Proponent owned network.

Back up electrical supply is provided in the form of 60No. low voltage 3MW standby LV generators to supply the data centre critical loads. Each generator will be housed in a prefabricated generator enclosure with noise attenuation and a belly tank, design to comply with AS1940, providing 48 hours fuel storage.

The connection offer received from Endeavour Energy is for two redundant, fully rated supplies of the entire site load at 132kV minimising the time that back-up generators are operational.

To meet the high water demands associated with the cooling equipment, both harvested rainwater and mains supplies will be used. Water and rainwater harvesting tanks will be installed to store water. Water and sewer connections will be provided from mains infrastructure within the estate. The proposed water main requires to be upsized to cater for the demands of the data centre.

Four (4) entry points for telecommunication supplies are proposed for the site, each separated by a minimum of 20m to ensure path diversity.

1 Abbreviations and Glossary

Abbreviations	
Colo	A colocation facility, or colo, is a data centre facility in which a business can operate or rent space for servers and other computing hardware.
kL	Kilo-litre (1000l – equivalent to 1m ³ volume)
MVA	Mega Volt Amp
MW	Megawatts
POEO	Protection of the Environment Operations Act
Proposal (the)	The purpose of the proposal is
SEARs	Secretary’s Environmental Assessment Requirements
UGOH	Underground to Overhead
WSC	Water Services Co-ordinator
WWTP	Waste water Treatment Plant

Contents

	Page
Executive Summary	1
1 Abbreviations and Glossary	2
2 Introduction	6
2.1 Purpose of this report	6
2.2 Proposal overview	7
2.3 SEARs and DCP requirements relevant to this report	10
3 Policy and planning context	13
3.1 Legislative context	13
4 Methodology	14
4.1 Study area	14
4.2 Method of Assessment	14
5 Existing environment	15
5.1 Electrical Services	16
5.2 Water Services	17
5.3 Sewer Services	17
5.4 Communications Services	18
5.5 Gas Services	19
5.6 Existing Stormwater Assets	19
5.7 Traffic Signals	20
5.8 Warragamba Pipeline	20
5.9 Consented Development	21
6 Servicing Strategies	22
6.1 Electrical Infrastructure and Back-Up Generators	25
6.2 Potable and Industrial Water	31
6.3 Sanitary Drainage	35
6.4 Telecommunications	38
6.5 Gas	39
7 Assessment of potential construction impacts	40
7.1 Electricity	40
7.2 Water Supply	40
7.3 Sewerage	40
7.4 Telecommunications	40
7.5 Gas	41
7.6 WaterNSW	41

8	Assessment of potential operational impacts	42
8.1	Electricity	42
8.2	Water and Sewerage	42
8.3	Telecommunications	42
8.4	Gas	42
8.5	WaterNSW	43
9	Environmental management measures	44
10	Summary of residual impacts	47
11	References	49

Tables

Table 1	SEARs and DCP requirements for Services and Infrastructure	10
Table 2	Site definitions	16
Table 3	Schedule of Utility Providers with assets in the near proximity of the estate	16
Table 4	Construction Staging of the data centre	24
Table 5	Site Electrical Maximum Demand	25
Table 6	Consultation Record	26
Table 7	Fuel Calculations	30
Table 8	Generator Testing Produces	30
Table 9	Fuel required for Testing Produces	31
Table 10	Environmental Management Measures for Utility Impacts	44
Table 11	Summary of pre-mitigation and residual impacts	47

Figures

Figure 1	Proposal Overview	8
Figure 2	Estate and Development Site Environment	15
Figure 3	Substation Location	17
Figure 4	Baseline Water Services	17
Figure 5	Sewer Connections Plan	18
Figure 6	Estate Telecommunications Plan	19
Figure 7	Baseline stormwater infrastructure plan	20
Figure 8	Estate Subdivision	21
Figure 9	On-site Utility Infrastructure	23
Figure 10	132kV Substation and Generator Location	25
Figure 11	Interim 22kV supply from future South Erskine Park ZS (<i>source Endeavour Energy 2020</i>)	28
Figure 12	Permanent 132kV supply from Sydney West BSP	29
Figure 13	Water Balance Schematic	33
Figure 14:	Water Servicing Options	35
Figure 15	Ultimate Waste water Discharge Forecast	36
Figure 16	Proposed Telecom Connection Strategy	38

Appendices

Appendix A

Dial Before You Dig (DBYD)

Appendix B

Electrical Consultations

Appendix C

Sydney Water Consultations

Appendix D

On-Site Utility Infrastructure

2 Introduction

2.1 Purpose of this report

The purpose of this report is to discuss the servicing and infrastructure requirements of the proposal, described in Section 2.2.

This technical report will outline the impacts of the proposal on existing public utilities within the proposal boundary and describes the proposed servicing strategy for the data centre. To satisfy the Secretary's Environment Assessment Requirements (SEARs) this report contains the following information:

- Overview of existing utility assets within the proposal boundary and necessary protection measures.
- Demand assessment for proposed services.
- Description of infrastructure delivery and staging.
- Summary of consultation undertaken with the relevant service provider.
- Description of proposed servicing strategy for each service with particular detail provided on the back-up electrical generators.

To serve the proposed data centre utility supplies from public networks outside the proposal boundary require to be conveyed to site. While these connections will be discussed within this chapter for information, works outside the proposal boundary are referred to as Related Development.

2.2 Proposal overview

2.2.1 Site context

The identified site address that is the subject of this technical report is legally defined as 757-769 Mamre Road, Kemps Creek. The entire Site comprises a total area of approximately 14.00 hectares (ha), split into three areas and is subject to the applicable provisions outlined within SEPP (WSEA) 2009. Access to the Site is currently obtained via the proposed Estate Access Roads (SSD 9522), which are accessed from Mamre Road. Access into the Site is made possible via Mamre Road, which is subject to future road widening as part of the Mamre Road Widening Project (Transport for NSW).

The Site is situated approximately 40.26 km west of the Sydney CBD, 22.11 km west of Parramatta and 11.97 km southeast of Penrith. It is within close proximity to transport infrastructure routes (predominantly the bus network), as well as sharing direct links with the wider regional road network, including Mamre Road and both the M4 & M7 Motorways. All of which provide enhanced connectivity to the Subject Site and immediate vicinity, as well as the wider locality.

Additionally, the Subject Site is located within close proximity to active transport links, such as bicycle routes, providing an additional mode of accessible transport available to the Subject Site. In its existing state, the Subject Site comprises an undeveloped land portion; however, is subject to bulk earthworks and infrastructure works under a concurrent State Significant Development (SSD) Application – SSD 9522.

The Proponent is proposing to construct and operate a Data Centre on the Subject Site. The Site is located within the Penrith Local Government Area (LGA) and is zoned IN1 General Industrial under the provisions of State Environmental Planning Policy (Western Sydney Employment Area) 2009 (SEPP (WSEA) 2009). Development for the purpose of a Data Centre is permissible with consent within the IN1 General Industrial zone pursuant to the provisions outlined with Part 3, Division 3, Clause 27 of State Environmental Planning Policy (Infrastructure) 2007 (ISEPP).

The site and surrounding context are illustrated below in Figure 1.

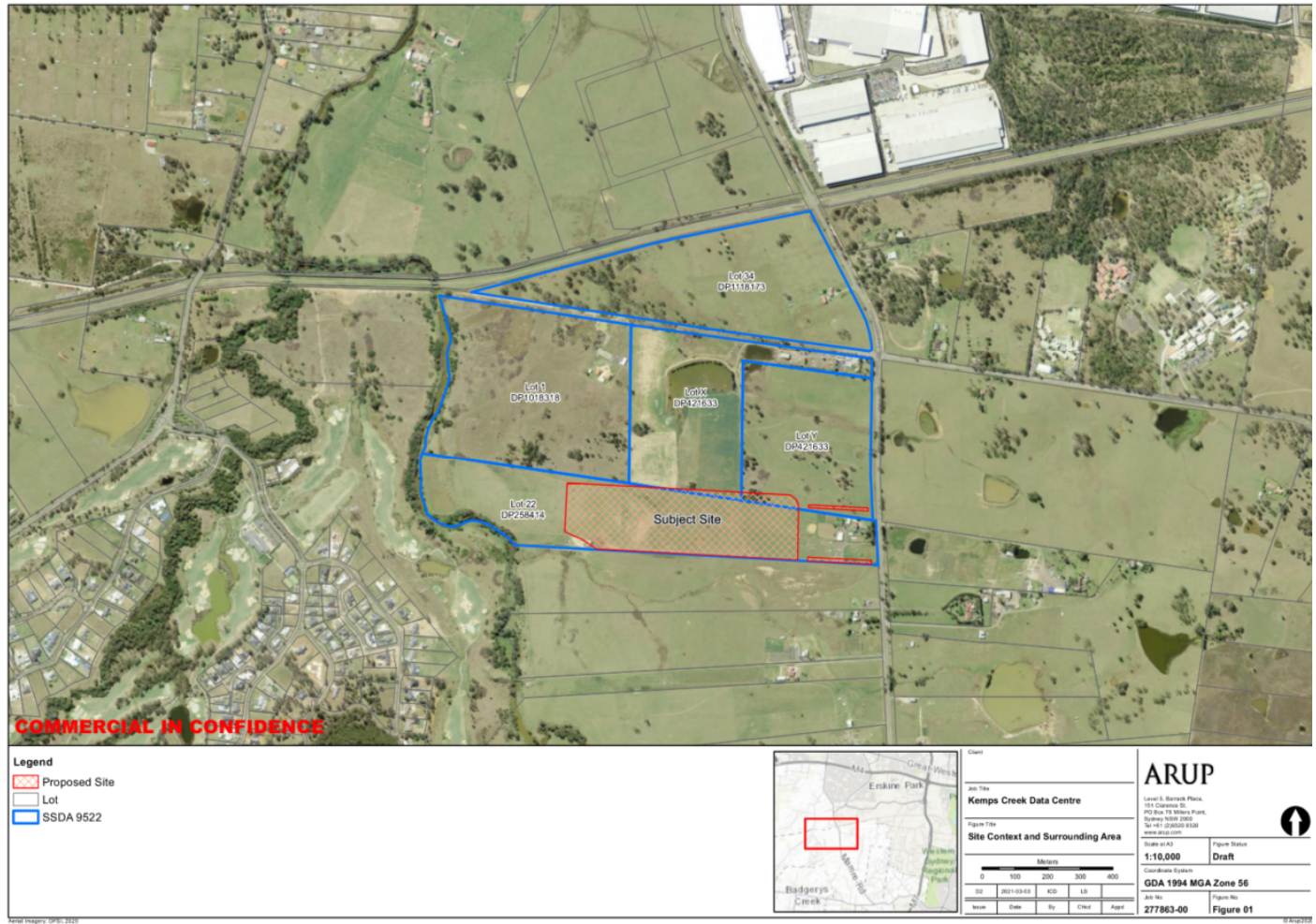

Figure 1 Proposal Overview

2.2.2 Description of the proposed development

The Site will form part of the new Kemps Creek Warehouse, Logistics and Industrial Facilities Hub being developed as a joint venture between Frasers Property and Altis Property Partner under the recently approved SSD 9522 as of 21st December 2020.

The site layout has been developed for three data centres for a total of (3 x 48MW) 144MW capacity. Full detailed design is currently underway for two 48MW centres, with the third data centre being designated as a future build. The design of these which are based on the end-client's reference design as well as applicable Australian standards.

2.3 SEARs and DCP requirements relevant to this report

Table 1 identifies the SEARs and DCP requirements which are relevant to this technical assessment.

Table 1 SEARs and DCP requirements for Services and Infrastructure

SEARs relevant to this technical report	Where addressed in this technical report
Infrastructure Requirements <i>A detailed written and/or graphical description of infrastructure required on the site, including any testing procedures and details for diesel generators, electrical substations and switch yard.</i>	Section 6
Infrastructure Requirements <i>Identification of any upgrades required off-site to facilitate the development, and describe any arrangements to ensure that the upgrades will be implemented in a timely manner and maintained.</i>	Sections 6.1 to 6.4
Infrastructure Requirements <i>An infrastructure delivery and staging planning, including a description of how infrastructure on-site and off-site will be co-ordinated and funded to ensure it is in place prior to the commencement of construction.</i>	Section 6.1
Infrastructure Requirements <i>An assessment of the impacts of the development on existing utility infrastructure and service provided assets surrounding the sites, and a description of how any potential impacts would be avoided and minimised.</i>	Section 7 and 8
Agency comments	
EPA – Electricity Generation <i>The EPA requests further information be provided on the back-up generators, including:</i> <ol style="list-style-type: none"> <i>Number of back-up generators proposed</i> <i>Individual capacity (in terms of megawatts and megajoules per second)</i> <i>Maximum operating time in an emergency situation</i> <i>Testing procedure, frequency and duration</i> <i>Confirmation that testing will be carried out individually or in clusters; and</i> <i>Justification of the need to test during the evening or at night</i> 	Section 6.1

<p>EPA – Electricity Generation</p> <p><i>The Environmental Impact Statement (EIS) should definitely state whether schedules testing will exceed that 200-hour annual limit. If the testing time is definitely stated to be less than 200 hours per annum, then DPIE may want to consider adding a condition of consent reflecting this. Alternatively, if testing time could exceed 200 hours per year, then the proposed activity may meet the trigger for Clause 17, schedule 1 of the POEO Act. Please note that the EPA would consider ‘operating’ to include testing, if testing involved starting the generator. In addition, the definition of ‘plant’ in the schedule activity includes all generators on the premises, not each individual generator.</i></p>	Section 6.1
<p>EPA – Chemical Storage</p> <p><i>The EPA requests clarification on the total volume of diesel proposed to be stored at the premises and the capacity of the tanks in which diesel is to be stored. Under Clause 9 of the POEO Act, an activity requires a license is there is a capacity to store more than 2,000 tonnes of petroleum products (which includes diesel).</i></p> <p><i>Information on the location and design of chemical bunding and containments should also be included in the EIS. If diesel storage tanks are above ground, bunding requirements are set out in AS 1940:2017 The storage and handling of flammable and combustible liquids.</i></p>	Section 5.1
<p>Sydney Water – Water-related Infrastructure Requirements</p> <p>1. <i>The proponent of the development should determine service demands following servicing investigations and demonstrate that satisfactory arrangements for drinking water, wastewater, and recycled water (if required) services have been made.</i></p>	Sections 6.2 and 6.3
<p>Sydney Water – Water-related Infrastructure Requirements</p> <p>2. <i>The proponent must obtain endorsement and/or approval from Sydney Water to ensure that the proposed development does not adversely impact on any existing water, wastewater or stormwater main, or any other Sydney Water asset, including easement or property. When determining landscaping options, the proponent should take into account that certain tree species can cause cracking or blockage of Sydney water pipes and therefore should be avoided.</i></p>	Sections 6.2 and 6.3
<p>Sydney Water – Water-related Infrastructure Requirements</p> <p>3. <i>Strict requirements for Sydney Water’s stormwater assets (for certain types of development) may apply to this site. The proponent should ensure that satisfactory steps/measures been taken to protect existing stormwater assets such as avoiding building over and/or adjacent to stormwater assets and building bridges over stormwater assets. The proponent should consider taking measures to minimise or eliminate</i></p>	Section 7.3

<i>potential flooding, degradation of water quality, and avoid adverse impacts on any heritage items, and create pipeline easements where required.</i>	
<p>Sydney Water – Integrated Water Cycle Management</p> <p>4. <i>The proponent should outline any sustainability initiative that will minimise/reduce the demand for drinking water, including any alternative water supply and end uses of drinking and non-drinking water that may be proposed, and demonstrate water sensitive urban design (principles are used), and any water conservation measures that are likely to be proposed. This will allow Sydney Water to determine the impact of the development on our existing services and required system capacity to service the development.</i></p>	Section 6.2
<p>WaterNSW</p> <p><i>WaterNSW’s main concern is the potential effects on the metallic Warragamba Pipelines from the proposed substation development within the site. Of specific concern are matters covered by applicable AS/NZS 4853:2012 Electrical hazards and metallic pipelines in respect of the below items.</i></p> <ol style="list-style-type: none"> 1. <i>Earth potential rise (EPR) from an earth fault causing step and touch voltages on or near the pipelines.</i> 2. <i>Low frequency induction (LFI) induced voltages on the metallic pipeline, and</i> 3. <i>Capacitive coupling.</i> 	Section 7.6

3 Policy and planning context

This Chapter presents relevant regulation, legislation and policy governing management of public utilities as it relates to the proposal.

3.1 Legislative context

3.1.1 Commonwealth Legislation

A number of Commonwealth legislative requirements to protect public utilities are noted below:

- Telecommunications Act 1997
- Security of Critical Infrastructure Act 2018

3.1.2 New South Wales Legislation

A number of NSW legislative requirements to protect public utilities are noted below:

- Protection of the Environment Operations Act 1997
- State Environmental Planning Policy (Infrastructure) 2007
- Electricity Supply Act 1995
- Gas Supply Act 1996
- Water Management Act 2000

3.1.3 Guidelines

- Fire safety guideline, Access for fire brigade vehicles and firefighters, ver 05.01, November 2020, Fire and Rescue NSW (FRNSW).
- Guidelines for Development Adjacent to the Upper Canal and Warragamba Pipelines, ver 3, February 2020, WaterNSW.
- Building over and adjacent to pipe assets, 2015, Sydney Water

4 Methodology

This Chapter outlines the methodology used to define the baseline and undertake the environmental assessment of potential impacts of the proposal on public utilities including definition of the study area used as the basis of the assessment.

4.1 Study area

The assessment area will be limited to the subject site (the site boundary) and two utility corridors connecting Mamre Road with the eastern boundary of the subject site.

An estate road separates the two utilities with the subject site. Wayleaves are to be agreed between relevant parties as part of later design stages to reflect

4.2 Method of Assessment

To address the project SEARs and address points raised by public utility authorities the following methodology was developed:

- Collate and review available data on existing public utilities; including conducting a Dial-Before-You-Dig (DBYD) search.
- Assess proposed site layout against any existing public utility infrastructure within the proposal boundary and identify any necessary protection or diversion works required.
- Undertake demand assessment for each core utility serving the data centre.
- Develop a site plan considering key, on-site utility infrastructure required to serve the data centre.
- Consult with all relevant service providers to determine necessary off-site utility upgrades.
- Consult with estate developer in developing integrated, estate utility networks.
- Define preferred point of connection or servicing strategy for the development for each service.

5 Existing environment

The existing undeveloped greenfield environment is subject to a concurrent consented state significant development (SSD-9522) which involves bulk earthworks and other estate infrastructure works. The finished state of the land after the completion of the consented estate development works will then be handed over to the Proponent for the construction of the proposed data centre.

As such, the post-development site of the consented estate development works will ultimately become the pre-development site for the proposed development and will be referred to as the “baseline” site within this report, as outlined in Table 2.

The estate site is bounded by the WaterNSW Warragamba Pipes to the north, Mamre Road and Bakers Lane to the East and residential areas to the west. Access to the estate and ultimately, the development site, can be made via the Mamre Road and Bakers Lane intersection as shown in Figure 2.

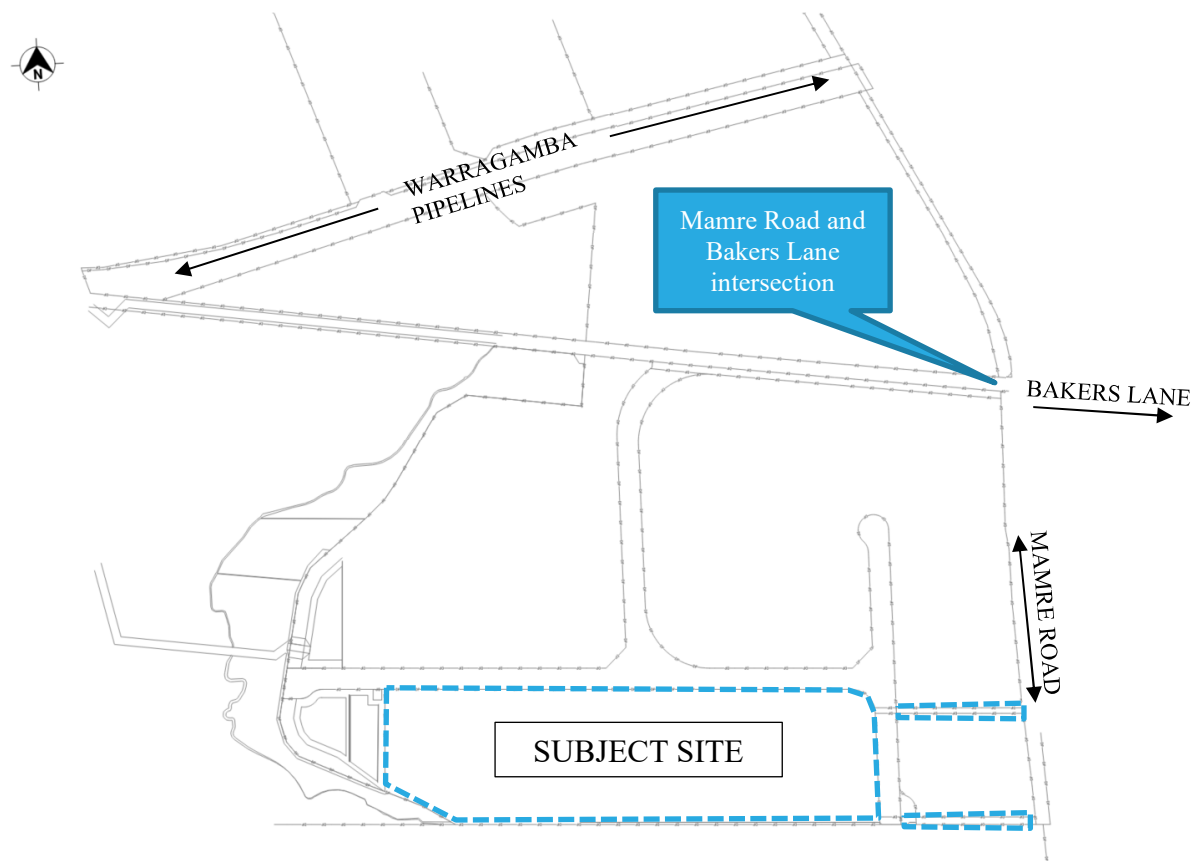

Figure 2 Estate and Development Site Environment

Table 2 Site definitions

Site	Definition within this report	State of the land within the site boundary
Existing	Pre-Consented Development	Greenfield/Undeveloped
Baseline	Post-Consented Development	Graded earthworks platform with temporary erosion and sediment control measures in place.

The consented development design accounts for the various future developments proposed within the estate site boundary, including the proposed data centre. The baseline site will feature:

- Connection stubs/points to the wider estate utility networks;
- Graded earthworks platform with raised site levels which provides flood immunity;
- Sediment and erosion control measures to suit the graded platform.
- Access roads bounding the northern and eastern baseline site boundary providing access to the proposed site

Existing utility provisions from DBYD searches and the consented estate design are described in sections 4.1 to 4.8. A copy of maps acquired from the DBYD search is contained within Appendix A.

The following utility providers have been identified (but not limited to) as known to have assets located in broader proximity to the estate area:

Table 3 Schedule of Utility Providers with assets in the near proximity of the estate

Utility Provider	Utility Type
Endeavour Energy	Electricity
Jemena	Gas
NBN Co	Communications
Sydney Water	Water supply / Sewerage / Stormwater
Telstra	Communications
TPG	Communications
Roads and Maritime Services (RMS)	Traffic Signals

5.1 Electrical Services

Within the subject site boundary, there are no existing electrical services present.

Existing underground electrical ducts run along Mamre Road up until the Bakers Lane intersection, based on DBYD information from Endeavour Energy (Refer to Appendix A).

Additionally, as part of the consented estate development works, a 1000 KVA substation by an appropriate vendor will be located within the north-east corner of the site boundary (refer to Figure 3). The location of the substation is shown as per current discussions with the proponent however, it is subject to change during later design stages to suit the final design.

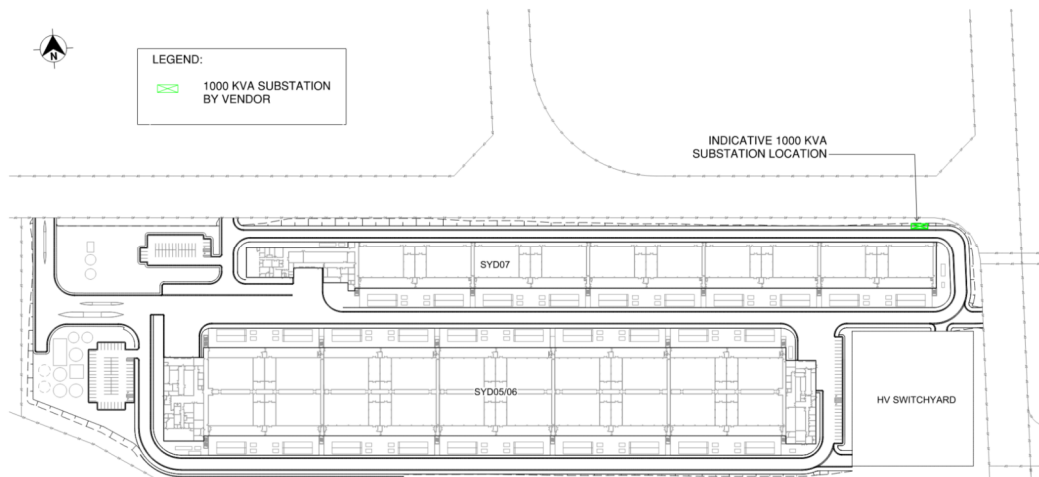

Figure 3 Substation Location

5.2 Water Services

There are no existing water services within the subject site boundary.

An estate water supply main will be located within the estate access road carriageways adjacent to the northern and eastern site boundary (refer to Figure 4). An existing 200mm DICL Sydney Water main bounds the northern and eastern estate boundary along Mamre Road and Bakers Lane.

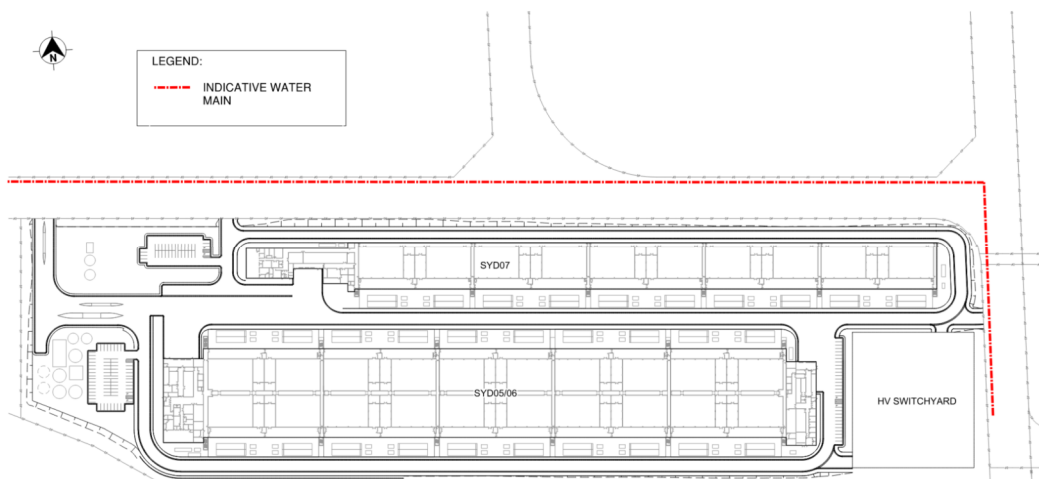

Figure 4 Baseline Water Services

5.3 Sewer Services

There are no existing sewerage services within the subject site boundary. The nearest sewerage service is located approximately 890m north of the subject site boundary. A 90mm PE Sydney Water sewerage line services the neighbouring northern estate lot.

As part of the SSD-9522, two (2) 225mm diameter sewer connection points provided by the estate developer will be located along the northern site boundary

(refer to Figure 5). The connection point locations shown are as per current discussions with the proponent and may be subject to change pending later design stages to suit the final design.

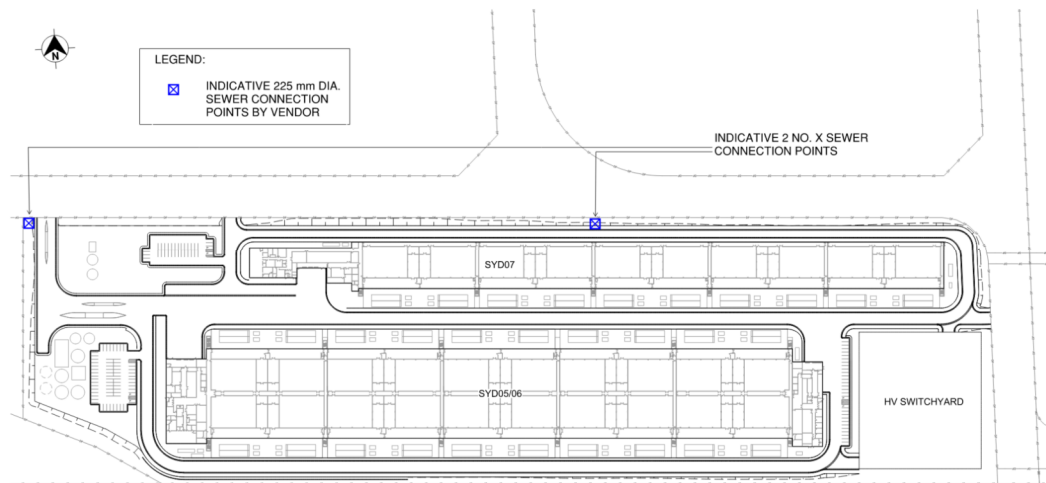

Figure 5 Sewer Connections Plan

5.4 Communications Services

There are no existing telecommunication services within the subject site boundary. Telstra conduits border the estate site along Mamre Road and Bakers Lane. A 35mm PVC pipe between a 1-pit and 9-pit, 10.5m apart exists within the estate boundary to the east of the development site boundary.

Short lengths of PIPE telecommunication ducts were identified from the TPG DBYD survey along Distribution Drive, Mamre Road and Bakers Lane. NBN services have also been identified to service the residential area approximately 550m south-west of the subject site and the northern adjacent estate.

The SSD-9522 works have allowed for six (6) 100mm telecommunication conduits to connect the estate to the wider telecommunications network at the Mamre Road and Bakers Lane intersection. Manholes will be spaced 180m apart along the conduit alignment. The estate has provided a connection point via a manhole at the northern boundary of the proposed site that is capable of reticulating six (6) 100mm conduits (refer to Figure 6). This location is as per current discussions with the proponent and may be subject to change during later design stages to suit the final design.

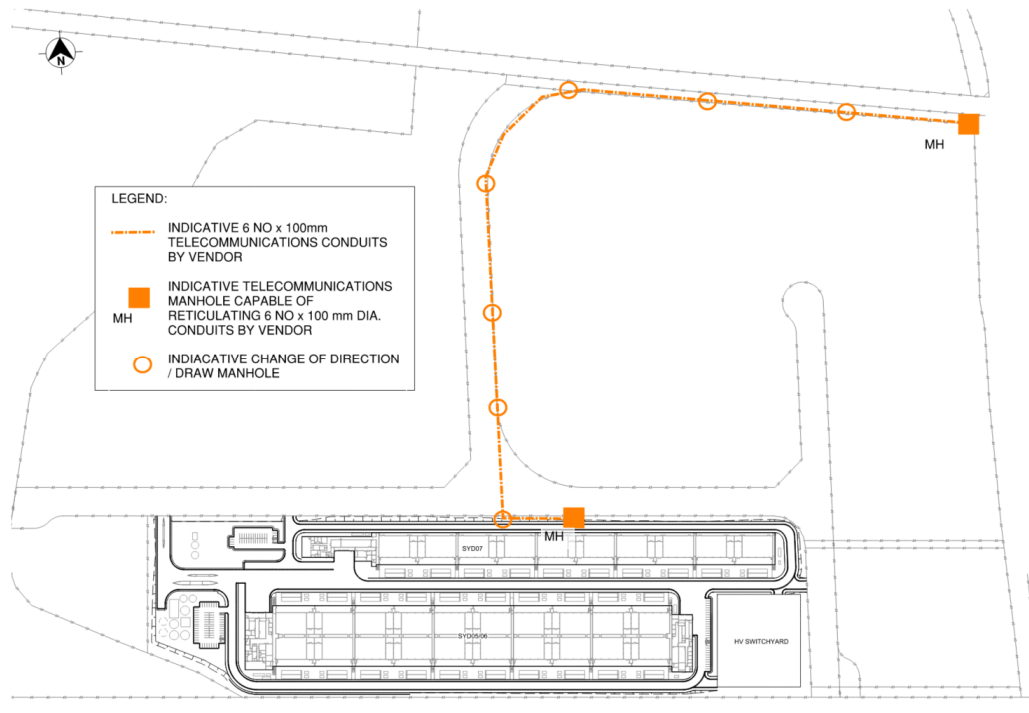

Figure 6 Estate Telecommunications Plan

5.5 Gas Services

There are no existing gas services within the subject site boundary. Based on the DBYD survey received from Jemena Gas, there is a 100mm Nylon 210kPa gas main which runs along Mamre Road to the east of the site.

5.6 Existing Stormwater Assets

The estate SSD-9522 will provide stormwater drainage pit and pipes around the eastern and northern perimeter of the site. The adjacent eastern lot will be serviced by a 375mm diameter pipe which will then run north along the road carriageway parallel to the eastern perimeter of the subject site. The drainage route then traverses across the internal access road where it will then follow the road carriageway parallel to the northern boundary of the subject site (refer Figure 7 to for the estate baseline stormwater infrastructure). The pipes along this section of the alignment range from 900mm to 1800mm diameter at the north-western corner of the subject site boundary. The estate stormwater system capacity has been designed in accordance with *Australian Rainfall and Runoff* (2016) and *Managing Urban Stormwater: Council Handbook* (EPA, 1997) guidelines.

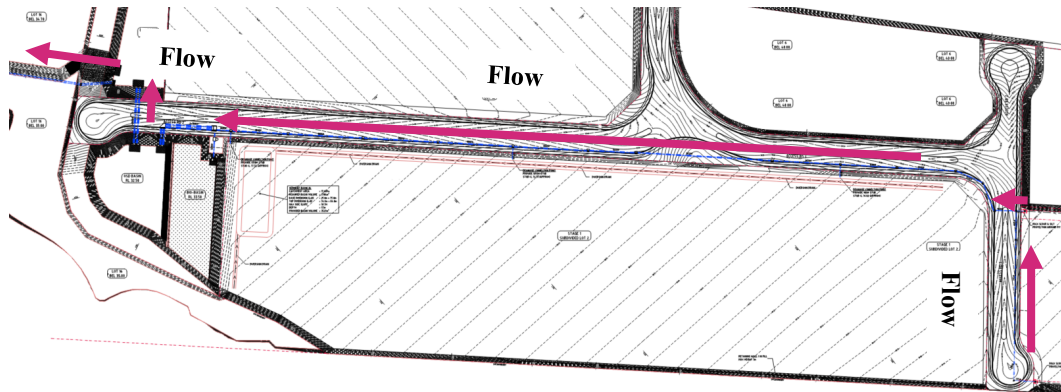

Figure 7 Baseline stormwater infrastructure plan

The baseline site will have three stormwater drainage connection stubs, located along the northern site boundary adjacent to Access Road 3. Further details of the stormwater connection points can be found within the Stormwater and Flooding Technical Report (Refer to Report No. SYD-05-06-07_C_R_0001).

5.7 Traffic Signals

As part of the SSD-9522, the Mamre Road and Bakers Lane intersection will have upgraded traffic control signals in accordance with Austroads Guide to Road Design and other relevant TfNSW supplements. Refer to the SSD-9522 for details regarding the design measures for the internal road network and Southern Link Road, Mamre Road, intersections work and all other estate roadworks and access.

No traffic signals are located within the subject site or immediately adjacent to the site boundary.

5.8 Warragamba Pipeline

The northern boundary of the subject site is approximately 750m from the WaterNSW Warragamba Pipeline corridor.

The northern estate site boundary is adjacent to the WaterNSW Warragamba Pipelines corridor. The estate design has taken its close proximity into account and is compliant with WaterNSW publication *Guidelines for development adjacent to the Upper Canal and Warragamba Pipelines*.

Reference should be made to the consented state significant development (SSD-9522) for details of these design measures.

5.9 Consented Development

The estate has been subdivided into numerous lots which are available for future developments (refer to Figure 8). The subject site includes the 3 No lots denoted “PT2” in Figure 8. The main site is west of the estate road with two narrow strips of land purchased to accommodate utility connections.

The consented development includes three internal access roads which are ultimately accessed via Mamre Road. The internal road network provides access to each of the individual lots within the estate, including the proposed site. Refer to SSD-9522 for details of the design measures and further information regarding the consented development.

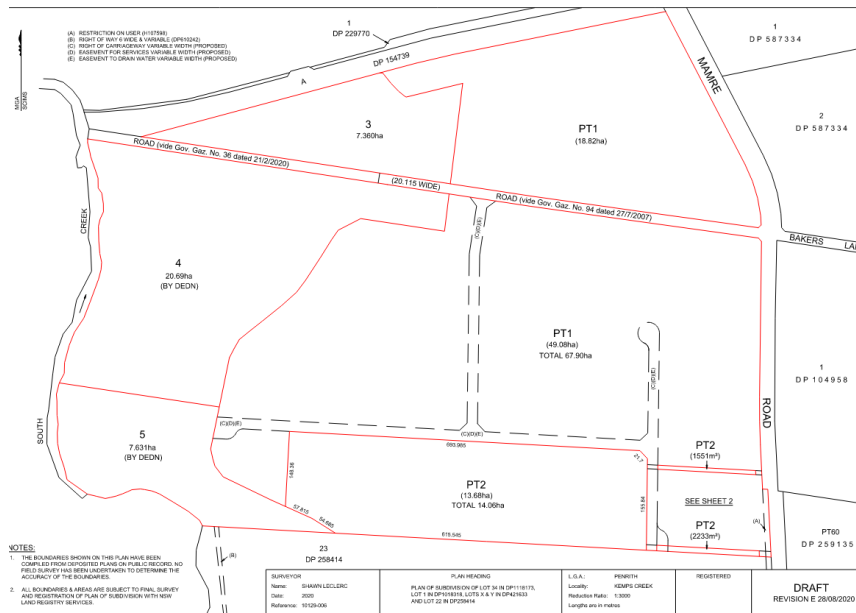

Figure 8 Estate Subdivision

6 Servicing Strategies

This Chapter describes the service demands and details the proposed servicing strategies for the development.

Data centres require to maintain a controlled temperature environment to safely operate the high density of equipment contained within the data halls. The outcome of this is a significant electrical and water demand which varies throughout the year depending on the ambient temperature. A large number of telecommunication conduits are also required to support a data centre.

When developing estate utility designs, SSD 9522 considered demands based on light industrial use. Given the higher electrical, water, sewer and telecommunications demands to serve the data centre, additional utility supplies are required. These higher demands are met by either augmenting proposed estate utility provision or by separate utility supplies. Further details are discussed in Sections 5.1 to 5.5.

Key on-site utility infrastructure required to serve the data centre are shown on Figure 9 and Appendix D and include:

- HV switching station & control room
- Back-up electrical generators
- Potable and industrial water tanks
- Fire tanks and pumps
- Connection points to estate and precinct infrastructure

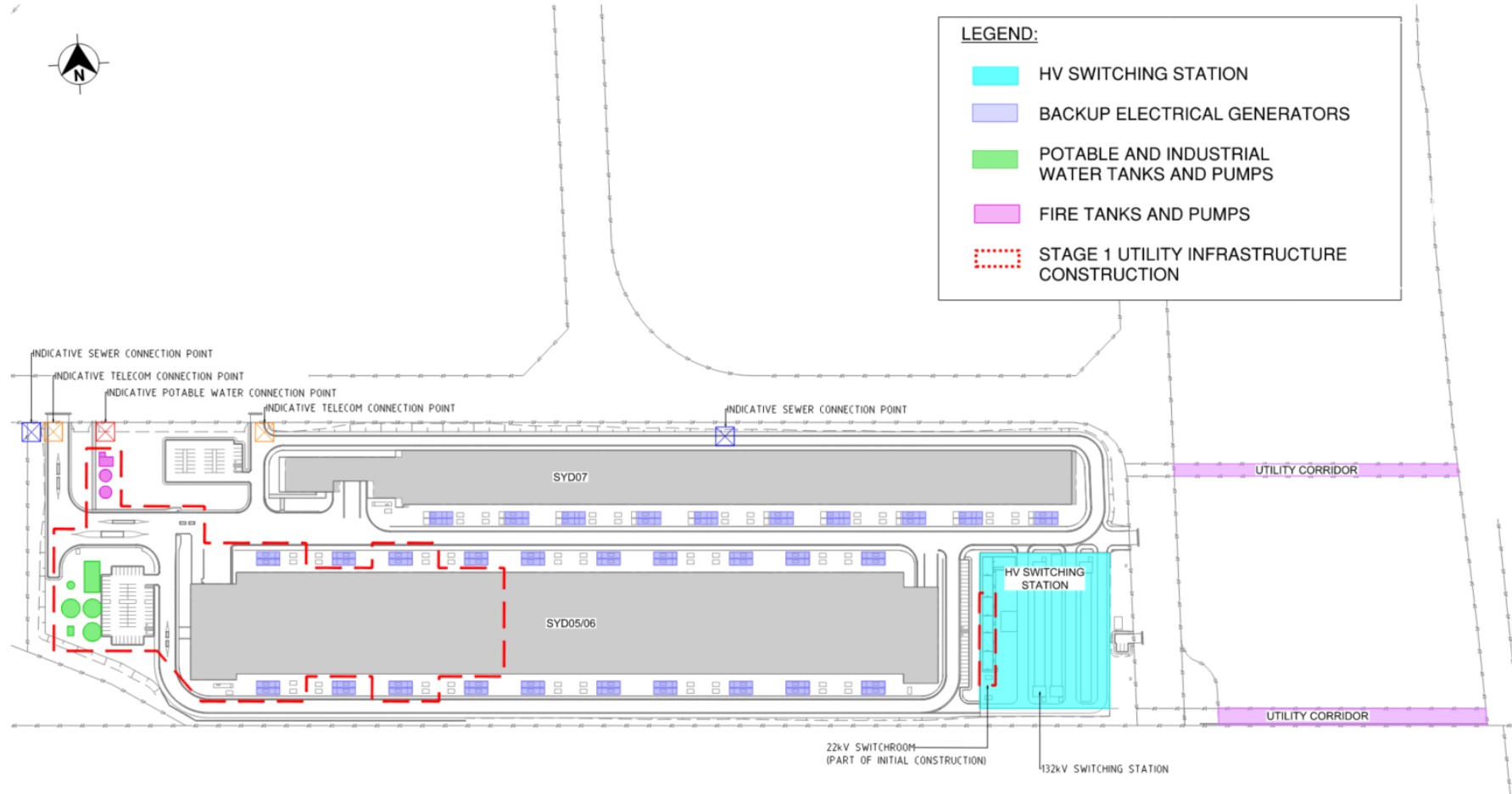

Figure 9 On-site Utility Infrastructure

To suit demand, construction of the data centre will be phased. The exact ramping programme is to be confirmed but anticipated to be in the order of 10 to 15 years. With the number of data halls increasing over a period of time, the increase in utility demand will follow a similar ramping profile.

The assessment and information presented in the following sections reflect the final arrangement however information is presented on key intermediate steps. Table 4 presents a high-level construction staging of the data centre.

Table 4 Construction Staging of the data centre

Stage	Built Form	Key Utility Provision
Stage 1 – Initial Construction	SYD05 shell (incl 1no SYD06 Colo shell). SYD05 fit out of Admin & 2no Colos.	22kV temporary switching station. Water and sewer connections to estate networks. Telecom connections to wider public networks. Fire water, potable water and rainwater harvesting tanks to serve SYD05 Colos. External generators to suit fit out staging.
Stage 2 – Within 7 years	SYD05 fit out phases (remaining internal Colos). SYD06 shell and fit out of Admin & initial Colo(s). SYD06 fit out phases (remaining internal Colos)	132kV switching station External generators to suit fit out staging. Additional fire water, potable water and rainwater harvesting tanks to suit later stages.
Stage 3 – Beyond 7 years	SYD07 shell (incl. associated car parking & other site works), and fit out of Admin & initial Colo(s). SYD07 fit out phases (remaining internal Colos).	External generators to suit fit out staging.

6.1 Electrical Infrastructure and Back-Up Generators

The proposed site is to be supplied by a new 132kV privately owned switching station and associated switchgear to cater for the ultimate site load.

The data centre is a mission critical facility and therefore requires back up generation. The site is designed for a total of 60 no. low voltage 3MW standby LV generators to supply the data centre critical loads. 2 of the 3 no. admin buildings will require generators for life safety loads, these will be low voltage 500kW emergency backup generators. All generators will be housed in a prefabricated, acoustic rated, generator enclosures with belly tanks to store diesel. All the generator enclosures will be free-standing on the external gantry area.

Location of the LV generators and 132kV substation depicted in Figure 10, shaded yellow and red respectively.

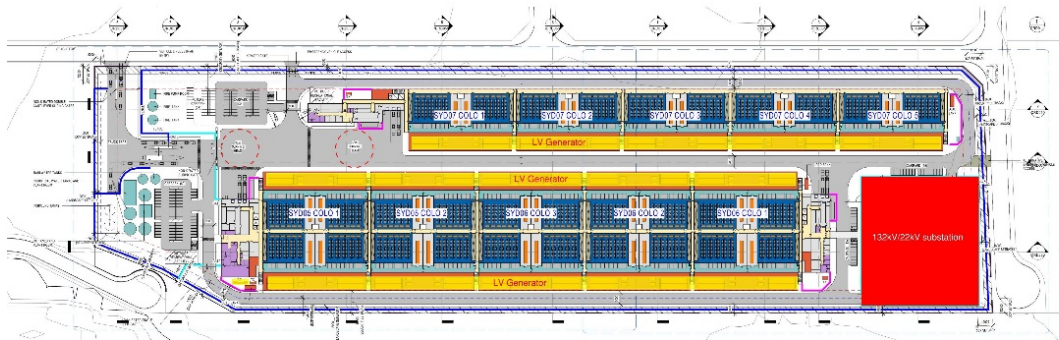

Figure 10 132kV Substation and Generator Location

6.1.1 Demand Estimate

The maximum demand is indicated in Table 5 below, the calculated demand for the proposed site is approximately 197MVA.

Table 5 Site Electrical Maximum Demand

Site Electrical Load Summary Result		
	Total Load	Unit
IT Load	144	MW
Total Load	187	MW
Calculated PUE	1.3	
Power Factor	0.95	
Total kVA	197	MVA

A 22kV temporary supply will be required until the 132kV connection is complete due to the associated program of the 132kV connection. 2 no. feeders at 22kV will temporarily supply the site, until the 132kV is available.

6.1.2 On site Electrical Infrastructure

The electrical infrastructure for the proposed data centre includes:

- A new 132kV/22kV switching station to cater for the overall consolidated site load, located at the southeast corner of the site.
- New temporary 22kV Endeavour Energy switching stations at the site boundary to serve as a point of connection for the temporary supply. The temporary switching station will be located within the same footprint as the 132kV/22kV switching station. The switching stations will be covered with easement in favour of Endeavour Energy.

The infrastructure in the new switching station will be owned by the Proponent and includes:

- 132kV switchgear for control of the incoming 132kV feeders, and protection and distribution to the 70MVA transformers
- 4 no. 70MVA 132/22kV transformers.
- 22kV switchgear to allow for protection, control, and distribution of power around the site via a 22kV Proponent owned network
- 2 no. 22/0.415kV Station services step down transformers to supply the electrical demands of the substation
- Additional miscellaneous equipment relating to SCADA, protection, control, and operation of the substation.

Site MV (22kV) reticulation will be by means of underground cabling.

6.1.3 Consultation

Consultation is currently being undertaken with the following stakeholders:

- Endeavour Energy
- Transgrid
- Environment Protection Authority

The information in Table 6 provides a full record of all consultation carried out. All the records are attached to Appendix B.

Table 6 Consultation Record

Stakeholders	Date	Outcomes/activities
Endeavour Energy	24 th March 2020	Submit a technical review request for 175MVA
Endeavour Energy	14 th April 2020	Update the load to 200MVA for technical review
Transgrid	15 th April 2020	Preliminary application for permanent supply of 200MVA
Endeavour Energy	27 th April 2020	Received a technical review for 132kV ultimate supply and temporary supply

Endeavour Energy	9 th September 2020	Endeavour energy (EE) acknowledged receipt of the permanent supply application of 175MVA EE advised one feeder may be supplied from Transgrid's Sydney West Bulk Supply Point (approx. 6.5km). The second feeder may be supplied from Mamre ZS (approx. 4.5km)
Endeavour Energy	16 th December 2020	Endeavour energy (EE) confirmed that South Erskine Park Zone Substation (SEPZS) can supply 13.6MVA with N+1 redundancy at 22kV EE advised potential feeder route is likely to follow future Southern Link Road from SEPZS to Bakers Lane, west along Bakers Land and turn south into Mamre Road. However, the feeder route is pending on the project timeline of Southern Link Road development.
Endeavour Energy	21 st December 2020	Endeavour energy (EE) acknowledged receipt of the permanent supply application of 197MVA EE advised one feeder may be supplied from Transgrid's Sydney West Bulk Supply Point (approx. 6.5km). The second feeder may be supplied from Mamre ZS (approx. 4.5km) EE advised 2 spare ducts through future Southern Link Road can be utilised as feeder routes for the interim supply. Concern for this option is that only partial N+1 redundancy can be achieved
Endeavour Energy	28 th January 2021	Endeavour Energy provided response suggesting provision of extra conduits along the future Southern Link Road to achieve the full N+1 redundancy for 13.6MVA temporary supply. Endeavour Energy advised: "Preferred location of the extra ducts on the opposite side of future Southern Link Road. However, this may impact the project delivery due to risk dealing with future Southern Link Road upgrade. " If 13.6MVA is only required for commissioning phase, the cable can be increased with the assessment of the risk
Environment Protection Authority	28 th January 2021	Environment Protection Authority (EPA) provided further explanation of Schedule 1, Clause 17 of the POEO Act and provided with examples of recent data centre SSDA advices

6.1.4 Connection Strategies

Both the interim 22kV supply and permanent 132kV supply routes are outside the subject site boundary and will be approved under the utility authority's own permitted development rights. The information presented in Sections 6.1.4.1 and 6.1.4.2 is based on recent correspondence with the utility providers and designs will be developed during later design stages.

6.1.4.1 Interim Strategy

The project team has been in discussion with Endeavour Energy about the project and possible electrical supply options. Endeavour Energy have confirmed that the requested capacity and arrangement of interim 22kV supply is available from South Erskine Park Zone Substation (SEPZS). Potential feeder route is likely to follow future Southern Link Road starting from SEPZS, and then to Bakers Lane, west along Bakers Lane and turn south into Mamre Road. The electrical supply will then be routed to main data centre site through one of the two narrow strips of land, that forms part of the subject site, between Mamre Road and the Estate Road. SEPZS and potential feeder route as depicted in Figure 11.



Figure 11 Interim 22kV supply from future South Erskine Park ZS (source Endeavour Energy 2020)

6.1.4.2 Permanent Strategy

As per Endeavour Energy's connection offer UCL10561 issued on 21st of December 2020, one (1) 132kV feeder will be supplied from Transgrid's Sydney West Bulk Supply Point (approx. 6.5km). The second feeder will be supplied from Mamre ZS (approx. 4.5km) as shown below. Both new feeders will be likely underground along the indicative routed highlighted in green (feeder 1) and blue (feeder 2) as shown below in Figure 12.

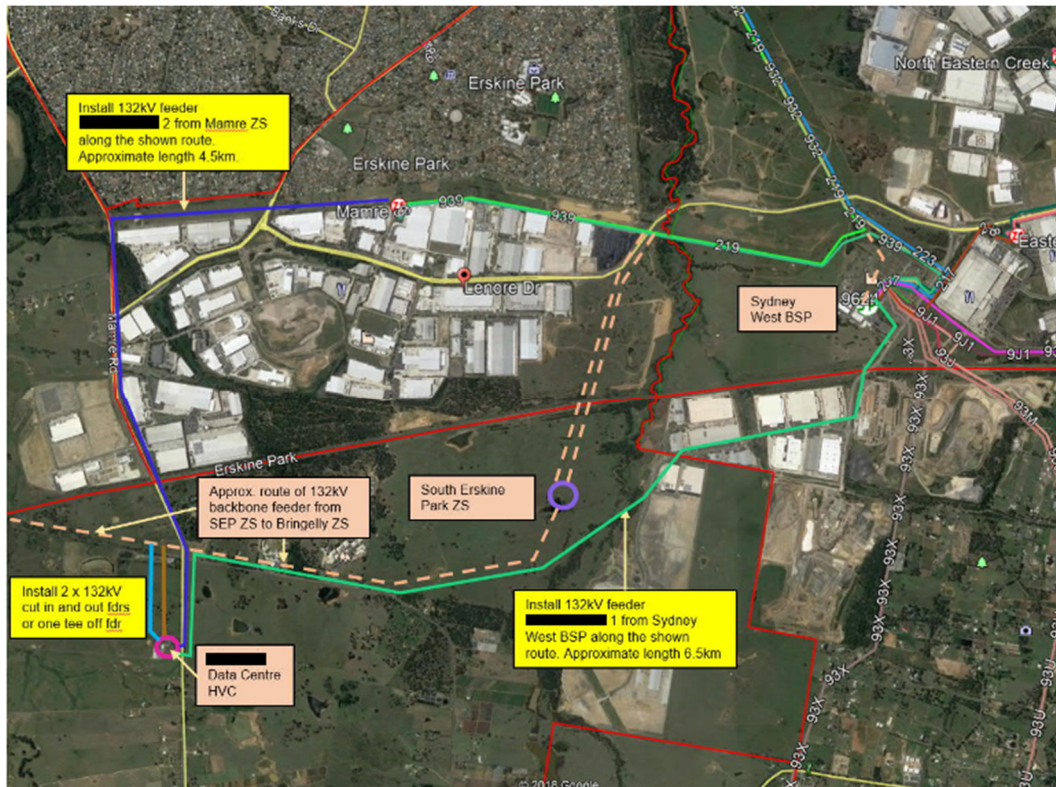

Figure 12 Permanent 132kV supply from Sydney West BSP

The 132kV supply route is anticipated to follow Mamre Road and connect to the HV switchyard via one of the two narrow strips of land, that forms part of the subject site, between Mamre Road and the Estate Road.

6.1.5 Back-Up Generators

The data centre is a mission critical facility and therefore requires back up generation. The site is designed for a total of 60 no. low voltage 3MW standby LV generators to supply the data centre critical loads. 2 of the 3 no. admin buildings will require generators for life safety loads, these will be low voltage 500kW emergency backup generators.

Generators will operate as a standby power supply in the event of mains failure. The connection offer received from Endeavour Energy is for two redundant, fully rated supplies of the entire site load at 132kV. Supply 1 is from TransGrid's Sydney West BSP; Supply 2 is from Endeavour Energy's Mamre Zone Substation. The probability of mains failure has been investigated for the electrical supply proposed by Endeavour Energy due to the criticality of the data centre. Failure rates for a supply in this arrangement are extremely low. The most recent interruption for a utility power supply from Sydney West BSP was in 2014 and lasted 13 minutes.

Each generator will be housed in a prefabricated generator enclosure with a belly tank providing 48 hours fuel storage. Fuel tanks will be designed to comply with AS1940. The generators enclosures are adjacent to one another therefore the fuel

tanks will be designed to allow for at least 600mm between inner tanks. Preliminary fuel calculations are shown in the table below.

Table 7 Fuel Calculations

	Data Hall Generator	Admin Building Generator	
Generator Rating	3	0.5	MW
Fuel Consumption	649.9 (75% Load)	133.2 (Full Load)	L/hr
Storage time	48	48	hr
Fuel Stored	31.2	6.4	kL
No. Generators (#)	60	2	
Site Fuel Storage			
Site Fuel Consumption	39260.4		L/hr
Total Fuel On Site (volume)	1884		kL
Total Fuel On Site (weight)	1668		t

Generator testing schedule indicated is as advised by the Proponent from similar facilities. The schedule is proposed to be applied to each individual generator.

It is advised by the Proponent that only one test will take place per month. Testing is restricted to one generator at a time, as there is only one load bank on the proposed site.

The EPA has advised (see Appendix B) that based on the text and statutory context of clause 17 of the POEO Act, that 'plant' is interpreted to encompass all generators on the premises collectively, and that 'operate' would also include testing should the internal combustible engines be turned on during testing. Applying the above testing schedule, the total testing time of the 62 generators will be 290 hours per year, which exceed 200 hours. Generators will be tested individually up to a maximum of 3MW at one time due to the load bank restriction.

Table 8 Generator Testing Produces

Test	Duration	Frequency
Engine - Diesel Run Test (No Load)	15 minutes	Monthly
Engine - Load Bank - Quarterly (70% load minimum)	30 minutes	Quarterly
Perform a generator full-load run	60 minutes	Annual

Table 9 Fuel required for Testing Produces

	Data Hall Generator	Admin Building Generator	
Generator Fuel Consumption - No Load	70.35	10.8	L/hr
Generator Fuel Consumption – 75% Load	649.9	99.6	L/hr
Generator Fuel Consumption – Full Load	817.7	133.2	L/hr
Annual Fuel Consumption for Generator Test	134.43675	0.7026	kL
Total Annual Fuel Consumption for Generator Test	135.13935		kL

6.1.6 Design Status at Submission

Endeavour Energy have sent connection offers for the temporary 22kV supply and permanent 132kV supply, correspondence included above. Detailed design of the HV supplies will be undertaken by an accredited Level 3 Accredited Service Provider as part of later design stages.

6.2 Potable and Industrial Water

The buildings within the site will be supply with both potable and industrial water supplies. Potable water will be supplied to the industrial water tanks, administration and bathroom areas as well as hose taps surrounding the site. Industrial water will supply the evaporative cooling system serving the data halls. In addition, the potable water supply backs up the industrial water tank fed supplies.

All tanks and pipework within the subject site will be owned and operated by the Proponent.

6.2.1 Potable Water

Potable water will be supplied from the Bakers lane water connection to the north of the site initially through the industrial estate (SSD 9522).

Potable water from Sydney Water’s water mains will supply the industrial water supply storage tanks and will also be used as a secondary water supply source to the industrial water system when the rainwater storage tanks are offline. In addition, potable water will also supply all sanitary fixtures and fittings within the administration building and COLO bathrooms.

6.2.2 Industrial Water

The industrial water system will supply the evaporative cooling system. The cooling system recirculates water 5 to 6 cycles prior to discharge reducing the net water demand. The industrial water system will be supplied primarily from

industrial water tanks located in a tank yard to the west of the site. An industrial water reticulation network will be installed, serving the SYD 05, 06 and 07 buildings. The reticulation network will be designed in a ring main configuration to provide an N+1 redundancy to the system.

The industrial water system will be supplied from the following sources;

- Potable water from the authority's water mains.
- Rainwater harvested from building roofs

The industrial water system will draw its water source in sequence as follows;

- Rainwater tanks
- Potable water

The industrial water supply will be filtered with automatic back wash filters and automatically chemically dosed to prevent legionella growth prior to being supplied to the evaporative cooling units.

6.2.3 Fire Water Supply

The site fire water supply will be provided from the authorities water main on the estate road the north of the site. The site will also have fire water storage tanks sized to provide 90 mins water supply during a fire event. The estimated the site fire water storage to be approximately 600kL.

6.2.4 Demand Estimate and Water Balance

It is intended to harvest the roof water of 60% of the SYD 05-06 building for use in the evaporative cooling process and for landscape irrigation. The roof water will be captured by a sealed inground rainwater drainage system which conveys the harvested rainwater to the tank yard located at the south west corner of the site. The rainwater will pass through an in-ground pollutant trap and be collected by a rainwater pump station where it will be transferred to an above ground 340,000 litre rainwater storage tank.

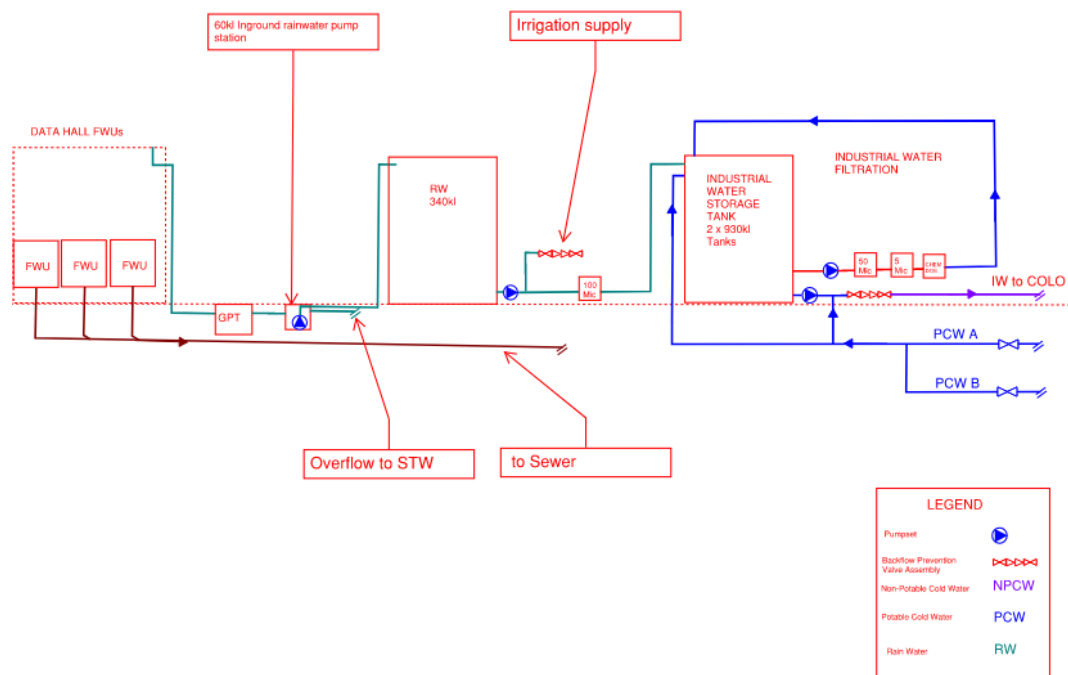

Figure 13 Water Balance Schematic

Water supplied to the evaporative cooler will be retained within the coolers' sump. Water within the sump will be pumped up to cooling pad and be partially evaporated to cool the supply air stream. To minimise water usage, the non-evaporated water will be recirculated from the sump to the pad to be evaporated. This recirculation process will occur until adequate evaporation process has taken place such that the concentration of solids within the sump water reaches six times the incoming water – achieving 6 cycle of concentrations.

In order to further reduce water consumption, the evaporative cooling system will only be switched on when ambient temperature is higher than 30°C. The cooling system will supply ambient air directly, without providing any form of cooling and hence not using water, when ambient temperature is less than 30°C.

Water balance

In the final configuration, when all data halls are operational, peak water demand days in hot periods of the year the data centre are estimated to use 2,787m³/day.

This demand will be reduced by utilising the rainwater stored in the sites 340,000 litre rainwater tank. The rainwater tank has been sized based on average highest daily rainfall received each month over the past 5 years which averages 20mm, and a roof catchment area of 17,000m². The average annual rainfall over the past 5 years has been calculated to be 656mm/year which provides 11.15 mega litres/year.

Based on the estimated annual average potable water consumption by the cooling systems of 87.85 mega litres/year (240.7m³ daily) the rainwater harvesting system could reduce the potable water consumption by 12% in the ultimate configuration and by higher percentages in early stages of the ramping profile.

It is intended to supply the site construction water requirements from either the existing Mamre Road authorities water main or from water tankers. Water for earthworks and dust suppression will be supplied from water tankers or from water within the sediment basin following filtering.

6.2.5 Consultation

6.2.5.1 Sydney Water

During early design stages a meeting was held with Sydney Water to understand their water and sewer strategies and anticipated delivery schedule for the wider Mamre Road Precinct.

A Section 73 application was made to Sydney Water in November 2020 providing anticipated maximum water and sewer demands, based on the peak operating day for the fully developed data centre. A formal response to this application was received on the 3rd of December 2020 and is contained in Appendix C.

The Proponent has appointed a Water Services Co-ordinator (WSC) and will continue to liaise with Sydney Water during the design process. A copy of the latest correspondence with Sydney Water, supporting the development, is also contained in Appendix C.

6.2.6 Connection Strategy

As advised by Sydney Water, the site shall be serviced by integrated water and sewer mains that serve the entire estate delivered as part of SSD 9522. The Proponent has engaged frequently with Altis-Frasers, the estate developer of SSD 9522, in order to reach an agreed servicing strategy.

For the water supply this requires the up-sizing of the proposed estate water main from DN 150 to DN 300. Two options were presented by Sydney Water and are presented in Figure 14. They comprise a new or upgraded DN300 water main extending from James Erskine Drive to the Mamre Road/Bakers Lane intersection along Bakers Lane. From the Bakers Lane/estate distributor road intersection, a new DN 300 water main will run under the estate roads/footpaths serving all Lots including the subject site. The proposed point of connection is near the north west corner of the subject site.

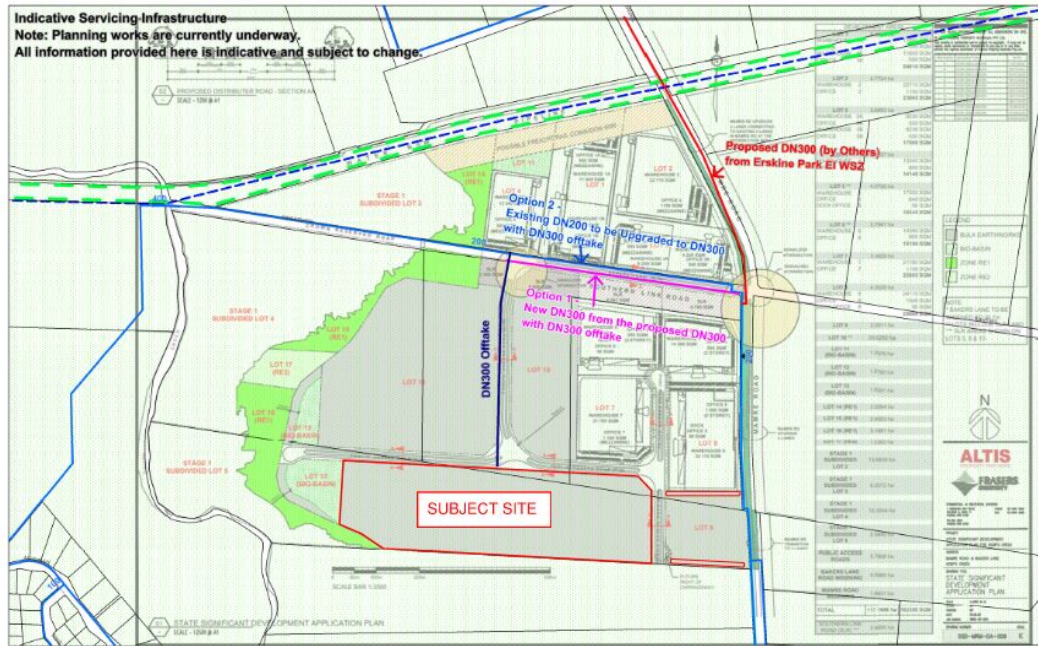

Figure 14: Water Servicing Options

6.2.7 On-site Water Reticulation

Potable Water Main

The incoming potable water main will enter the site at the north-western boundary and will be directed to the tank yard at the south west of the site. The potable water main will supply the industrial water tanks, administration buildings and bathrooms within the COLOs.

Fire Water Mains

The incoming fire main will enter the site at the north-western boundary and will be routed towards the booster pump set adjacent to the main site entrance.

A fire reticulation network is proposed around the data halls, located under the site roads/footpath, which will supply the proposed hydrants.

6.3 Sanitary Drainage

The site will be serviced by sanitary drainage system that will gravity drain to both sewer connections provided by the estate developer. The sanitary drainage will be separated into soil waste and waste water drainage systems within the data halls.

6.3.1 Soil waste

The soil waste drainage will collect all sanitary fixtures within the administration buildings and the data halls. This drainage system will run separately to the waste water system throughout the data halls and will merge prior connecting to the 2No sewer connections located at the north and north west boundaries of the subject site.

6.3.2 Waste water

The waste water system will collect all the evaporated cooling system waste water as well as all floor waste and tundishes within the data halls. The waste water drainage systems shall run separately to the soil waste systems throughout the data halls and will merge to the site's sanitary drainage system prior to site discharge via the 2No sewer connections located at the north and north west boundaries of the subject site.

6.3.3 Demand Estimate

The majority of the site's discharge is from the waste water generated by the evaporated cooling system waste water. The soil waste discharge will be minimal due to relatively low staff number in relation to the size of the facility.

The ultimate waste water discharge forecast are detailed below in Figure 15;

2036 Month	No of Days	Total Monthly (kL)			Average Daily (kL)		Peak Day Sewer Flows	
		Cooling	Sanitary	Total	Sewer Flow	Peak Day Demand (kL)	Peak Flow Rate (l/s)	
144MW January	31	2098.91	155.00	2253.91	72.71	485.9	25.2	
February	28	603.66	140.00	743.66	26.56			
March	31	576.53	155.00	731.53	23.60			
April	30	494.19	150.00	644.19	21.47			
May	31	0.00	155.00	155.00	5.00			
June	30	0.00	150.00	150.00	5.00			
July	31	0.00	155.00	155.00	5.00			
August	31	0.00	155.00	155.00	5.00			
September	30	580.89	150.00	730.89	24.36			
October	31	1031.34	155.00	1186.34	38.27			
November	30	961.50	150.00	1111.50	37.05			
December	31	1445.73	155.00	1600.73	51.64			
Annual Total		7792.74	1825.00	9617.74				

Figure 15 Ultimate Waste water Discharge Forecast

As detailed on the calculations above the forecast at the ultimate load when the site is fully developed at the hottest times of year in January will on average 72 kl/day with a peak discharge flow rate of 25.2 l/sec. The cooler winter months down to 5 kl/day as water will not be required in the evaporative cooling process.

Sewer demands are significantly lower than peak water demands as industrial water is recirculated six times prior to discharge from the cooling equipment to the waste water system. In earlier year of operation, the sewer demands will be significantly lower than those presented in Figure 12.

6.3.4 Consultation

A Section 73 application was made to Sydney Water in November 2020 providing anticipated maximum water and sewer demands, based on the peak operating day for the fully developed data centre. A formal response to this application was received on the 3rd of December 2020 and is contained in Appendix C.

Sydney Water confirmed that the estate currently has no sewerage infrastructure in operation. Precinct sewerage infrastructure, comprising a sewer pump station and rising main, is being delivered by Sydney Water and is anticipated to be operational Q3-Q4 2023. Sydney Water advised than an Interim Operation Plan

(IOP) for interim sewer servicing is required until the delivery of Sydney Water's infrastructure. The IOP is held by the estate developer and Sydney Water noted they would not approve an additional IOP within the estate.

As such, the Proponent has consulted with the estate developer to augment the capacity of the estate IOP to consider sewer flows from the proposed data centre.

The Proponent has appointed a Water Services Co-ordinator (WSC) and will continue to liaise with Sydney Water during the design process. A copy of the latest correspondence with Sydney Water, supporting the development, is also contained in Appendix C.

6.3.5 Connection Strategy

The proposed connection strategy is to drain sanitary drainage by gravity to the sewer connection provisions constructed as part of SSD 9522 at the north west and north of the site.

The SYD 05/06 building will drain to the north west sewer connection and the SYD 07 building will drain to the northern sewer connection.

6.3.5.1 Construction Stage

During initial construction stages, prior to the IOP being commissioned, construction compounds will be served by storage tanks/septic tanks with effluent disposed of at a licensed, off-site facility via tankers.

6.3.5.2 Interim Configuration

The IOP is anticipated to be operational from 2022. Sewer flows from the site will be conveyed by gravity to the estate gravity sewer via the 2No stub connections along the northern boundary of the subject site. Once in the estate network, they will drain to a temporary holding tank, located within the estate, and either trucked or pumped to a suitable wastewater facility.

The exact IOP arrangement is to be confirmed by the estate developer.

6.3.5.3 Permanent Configuration

In the permanent configuration, sewer flows will continue to drain from the site to estate sewer system via the 2No stub connections along the northern boundary of the subject site. The estate network will then drain directly into Sydney Water's precinct pump station which would transfer flows to St Mary's wastewater treatment works until 2026, after which flows would transfer to the new Upper South Creek Advanced Water Recycling Centre.

6.3.6 On-Site Reticulation

The soil waste drainage and waste drainage systems for SYD 05/06 will reticulate in the south and central site roads and merge prior to discharge to the 225mm sewer connection stub located at the north west corner of the site.

The soil waste drainage and waste drainage systems for SYD 07 will reticulate in the north and central site roads and merge prior to discharge to the 225mm sewer connection stub located at the northern boundary of the site.

6.4 Telecommunications

6.4.1 Connection Strategy

Four (4) entry points are proposed for the site, each separated by a minimum of 20m to ensure path diversity, as shown in Figure 16. These entry points are separate to the 6 x 100mm diameter telecom conduits within the wider estate.

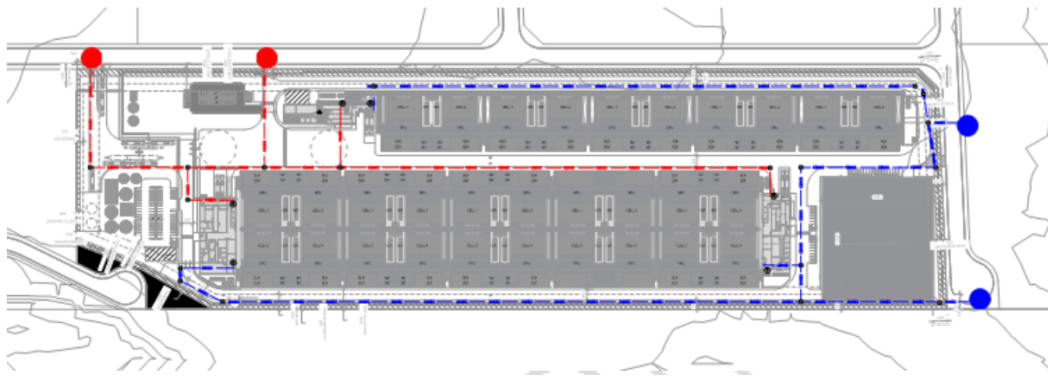

Figure 16 Proposed Telecom Connection Strategy

Carriers will likely provide connectivity to the entry points at the North West of the site (shown red) via the public access road to the north of the site.

Connectivity to the Eastern entry points (shown blue) will be from Mamre Road and will reticulate through the narrow strips of land, east of the internal distributor road, that form part of the subject site.

The proponent are in ongoing negotiations with their carriers of choice to finalise routes to the site.

6.4.2 On-Site Reticulation

Within the main site, a series of 24x100mm conduits will reticulate under site roads and footpaths to support telecommunications lead-in cabling and distribution pathways.

Each Administration Block will be provided with connectivity to the Eastern and Western Points of Entry to ensure physical diversity to each data centre building.

The eastern and western communications pathways always retain a minimum of 20m separation to minimise risk of concurrent damage to multiple pieces of telecommunications infrastructure.

6.5 Gas

No gas supply is proposed to serve the data centre facility. All power supplies will be from electrical sources with auxiliary supply from diesel generators. As such no consultation with Jemena has been undertaken.

There are no existing gas services within the proposal boundary and therefore the development causes no impact to existing gas networks.

7 Assessment of potential construction impacts

This chapter presents potential construction impacts on existing utility infrastructure within the subject site.

As discussed in Section 6, construction works will be undertaken in stages over a period of time.

7.1 Electricity

In the baseline condition there is no existing electrical infrastructure within the subject site. Therefore, construction works within the subject site will cause no impacts to electrical infrastructure.

During later construction stages, measures will be implemented to avoid damage to electrical services and infrastructure constructed during initial stages of work.

7.2 Water Supply

In the baseline condition there is no water infrastructure within the subject site. Therefore, construction works within the subject site will cause no impacts to water infrastructure.

During later construction stages, measures will be implemented to avoid damage to water services constructed during initial stages of work.

7.3 Sewerage

In the baseline condition there is no sewer infrastructure within the subject site. Therefore, construction works within the subject site will cause no impacts to sewer infrastructure.

During early construction stages, sewer flows will require to be stored on site temporarily and trucked off-site to a licensed facility. There is a risk of spills of effluent onto the site or the wider environment.

During later construction stages, measures will be implemented to avoid damage to sewer services constructed during initial stages of work.

7.4 Telecommunications

In the baseline condition there is no telecom infrastructure within the subject site. Therefore, construction works within the subject site will cause no impacts to telecom infrastructure.

During later construction stages, measures will be implemented to avoid damage to sewer services constructed during initial stages of work.

7.5 Gas

No gas supply is proposed to serve the data centre facility. All power supplies will be from electrical sources with auxiliary supply from diesel generators. There are also no existing gas services within the subject site boundary and therefore the development causes no impact to existing gas networks.

7.6 WaterNSW

Given that the subject site boundary is 750m south of the WaterNSW Warragamba Pipelines, the construction of the HV switchyard and back-up electrical generators within the subject site will not have any impact on the Warragamba Pipelines.

Both the interim 22kV supply and permanent 132kV supply routes are outside the subject site boundary and will be approved under the utility authority's own permitted development rights. The design of these supply routes will be undertaken by an accredited Level 3 Accredited Service Provider as part of later design stages and will include consultation.

8 Assessment of potential operational impacts

Section 8 presents potential operational impacts that the development could have on the surrounding environment and public utility networks.

8.1 Electricity

Potential operational impacts of the electrical infrastructure within the subject site include:

- High electrical demand impacting the surrounding HV distribution network.
- High noise levels when testing or operating back-up generators.
- Fuel spills when filling generators.
- Fire and explosion risks associated with the generators.
- Fire and explosion risks associated with the switching station.
- Air pollution when generators are operational.

8.2 Water and Sewerage

Potential operational impacts of the water and sewer infrastructure include:

- High demands reducing the capacity of the estate or precinct water and sewer networks.
- Overtopping of rainwater harvesting/water storage tanks.

8.3 Telecommunications

The key operational issue for the Proponent is that the facility can operate in the event one telecoms route is offline. The facility will be serviced by separate telecom supply routes to ensure path diversity,

8.4 Gas

No gas supply is proposed to serve the data centre facility. All power supplies will be from electrical sources with auxiliary supply from diesel generators. There are also no existing gas services within the proposal boundary and therefore the development causes no impact to existing gas networks. As such there is no potential risk during the operational and maintenance phase.

8.5 WaterNSW

Given that the subject site boundary is 750m south of the WaterNSW Warragamba Pipelines, the operation of the HV switchyard and back-up electrical generators within the subject site will not have any impact on the Warragamba Pipelines.

9 Environmental management measures

Table 10 details the proposed management and mitigation measures proposed as part of the design for utility impacts.

Table 10 Environmental Management Measures for Utility Impacts

ID	Impacts	Mitigation	Responsibility	Timing
IR1	High electrical demand impacting the surrounding HV distribution network.	Proposals are to have data centre specific electrical supply. Electrical authorities have confirmed that capacity exists within the network to serve the site.	Proponent/Electrical Authority	Design
IR2	High noise levels when testing or operating back-up generators.	Generators are containerised units which include noise attenuation features. The noise level of generator testing will be assessed against NSW Noise Policy for Industry.	Proponent/Contractor	Design and Operation
IR3	Fuel spills when filling generators.	Fuel tanks will be designed to comply with AS1940. Fuel tanks will be double walled. Each fill point will have all ancillaries to meet requirements of AS1940.	Proponent/Contractor	Design and Operation
IR4	Fire and explosion risks associated with the generators.	Generators will be designed in accordance with AS 1940 which defines minimum clearance from building and separation between fuel storage tanks (“belly tanks”). Generators located behind security fencing/gates meaning only approved personnel can access this area.	Proponent/Contractor	Design and Operation
IR5	Fire and explosion risks associated with the switching station.	HV switching station will be designed by a certified Level 3 ASP designer in accordance with relevant current version of Australian Standards and Industry Associations Standards and Guidelines. Switching station located behind security fencing/gates meaning only approved personnel can access this area.	Proponent/Contractor	Design and Operation

ID	Impacts	Mitigation	Responsibility	Timing
IR6	Air pollution when generators are operational	Two separate mains supply routes are proposed and the probability of mains failure has been investigated for the electrical supply. Failure rates for a supply in this arrangement are extremely low meaning the generators will rarely be used. Generators will include specific emissions control measures and will be Tier 2 certified to Australian EPA requirements.	Proponent	Design and Operation
IR7	High demands reducing the capacity of the estate or precinct water and sewer networks.	To minimise the peak water demand on Sydney Water's potable water network, the water balance of the proposed site has been maintained through the use of rainwater re-use tanks and the provision of fire and water storage tanks on site. Consultation with Sydney Water through the design process has confirmed that the precinct wide water and sewer networks will be designed to cater for peak day flows from the final configuration of the data centre.	Proponent / Sydney Water	Design / Construction
IR8	Overtopping of rainwater harvesting/water storage tanks.	Water overtopping from the rainwater tanks will discharge to the stormwater system. Discharged water will not contaminate the surrounding environment as it will be from either mains supply or roof collected which has passed through water quality treatment features.	Proponent	Design / Operation
IR9	Spills/leakages from on-site storage of effluent during early stages of construction.	On-site storage features such as septic tanks will be in accordance with the relevant Australian Standards. The Contractor shall locate the storage tanks in an appropriate location within the site and shall empty the tanks on a regular basis.	Proponent / Contractor	Design / Construction
IR10	Redundant telecoms supply	Each of the administration buildings is concurrently connected to the Eastern and Western Points of Entry, providing the operator with the ability to utilise a physically diverse service in the event of failure.	Proponent	Design / Operation

ID	Impacts	Mitigation	Responsibility	Timing
		All telecommunications pathways are physically separated by a minimum of 20m to minimise risk of concurrent damage to multiple pieces of telecommunications infrastructure.		

10 Summary of residual impacts

This section provides a summary of the construction and operational risks both pre-mitigation and any residual impacts remaining after the implementation of the management measures describe in Section 7. Pre-mitigation and residual impacts are summarised in Table 11.

Table 11 Summary of pre-mitigation and residual impacts

Potential pre-mitigation adverse impact	Relevant management measures	Potential residual impact after implementation of management measures	Comment on how any residual impacts would be managed
Construction			
Spills/leakages from on-site storage of effluent during early stages of construction.	On-site storage features such as septic tanks will be in accordance with the relevant Australian Standards. The Contractor shall locate the storage tanks in an appropriate location within the site.	Low risk that spills occur during loading of waste to tanker.	Contractor to use a licensed and certified waste disposal company who have relevant accreditation and provide a safe working method statement for filling operations. Storage tank(s) to be regularly inspected during operation for damages that may cause leaking.
Operation			
High noise levels when testing or operating back-up generators.	Generators are containerised units which include noise attenuation features. Generators will only operate in the unlikely event that both electrical supplies are off-line.	Potential that noise levels are high.	The noise level of generator testing will be assessed against NSW Noise Policy for Industry. Testing of generators to be undertaken during daytime periods unless otherwise required.

Potential pre-mitigation adverse impact	Relevant management measures	Potential residual impact after implementation of management measures	Comment on how any residual impacts would be managed
Fuel spills when filling generators.	Fuel tanks will be double walled. Each fill point will have all ancillaries to meet requirements of AS1940.	Risk of accidental spills when fuelling.	Operator to prepare a management plan detailing safe method of work for filling generators. Supplier to have spill kits available at the time of filling.
Fire and explosion risks associated with the generators.	Generators positioned suitably clear from buildings. Suitable separation provided between fuel storage tanks (“belly tanks”) and generators. Access to generators limited to approved personnel.	Low risk of fire and explosion.	Operator to implement monitoring and maintenance plan. Generator area to be kept clean and free from flammable materials. Generators to be frequently inspected for faults/defects.
Fire and explosion risks associated with the switching station.	HV switching station will be designed by a certified Level 3 ASP designer in accordance with relevant current version of Australian Standards and Industry Associations Standards and Guidelines Access to generators limited to approved personnel.	Low risk of fire and explosion.	Operator to implement monitoring and maintenance plan. Switching station to be kept clean and free from flammable materials. Switching station to be frequently inspected for faults/defects.

11 References

Australian Rainfall and Runoff, 2016. *Australian Rainfall and Runoff*.

Environmental Protection Authority, 1997. *Managing Urban Stormwater: Council Handbook*.

NSW Government, 1997. *Protection of the Environment Operations Act*.

NSW Government, 2007. *State Environmental Planning Policy (Infrastructure)*.

NSW Government, 2009. *State Environmental Planning Policy (Western Sydney Employment Area)*.

Appendix A

Dial Before You Dig (DBYD)

A1 Endeavour Energy

WARNING

- **All electrical apparatus shall be regarded as live until proved de-energised.** Contact with live electrical apparatus will cause severe injury or death.
- In accordance with the *Electricity Supply Act 1995*, you are obliged to report any damage to Endeavour Energy Assets immediately by calling **131 003**.
- The customer must obtain a new set of plans from Endeavour Energy if work has not been started or completed within twenty (20) working days of the original plan issue date.
- The customer must contact Endeavour Energy if any of the plans provided have blank pages, as some underground asset information may be incomplete.
- Endeavour Energy underground earth grids may exist and their location **may not** be shown on plans. Persons excavating are expected to exercise all due care, especially in the vicinity of padmount substations, pole mounted substations, pole mounted switches, transmission poles and towers.
- Endeavour Energy plans **do not** show any underground customer service mains or information relating to service mains within private property.
- Asbestos or asbestos-containing material may be present on or near Endeavour Energy's underground assets.
- Organo-Chloride Pesticides (OCP) may be present in some sub-transmission trenches.
- All plans must be printed and made available at the worksite where excavation is to be undertaken. Plans must be reviewed and understood by the crew on site prior to commencing excavation.

INFORMATION PROVIDED BY ENDEAVOUR ENERGY

- Any plans provided pursuant to this service are intended to show the approximate location of underground assets relative to road boundaries, property fences and other structures at the time of installation.
- Depth of underground assets may vary significantly from information provided on plans as a result of changes to road, footpath or surface levels subsequent to installation.
- Such plans have been prepared solely for use by Endeavour Energy staff for design, construction and maintenance purposes.
- All enquiry details and results are kept in a register.

DISCLAIMER

Whilst Endeavour Energy has taken all reasonable steps to ensure that the information contained in the plans is as accurate as possible it will accept no liability for inaccuracies in the information shown on such plans.

LEGEND

- OR ■ Street light column
- ▭ Padmount substation
- OR ■ Overground pillar (O.G.Box)
- ▭ Underground pit
- Duct run
- Cable run
- ⊙ Typical duct section
- ▲ Asbestos warning



NOT TO SCALE

DBYD Sequence No.:	105300013
Issued Date:	07/01/2021

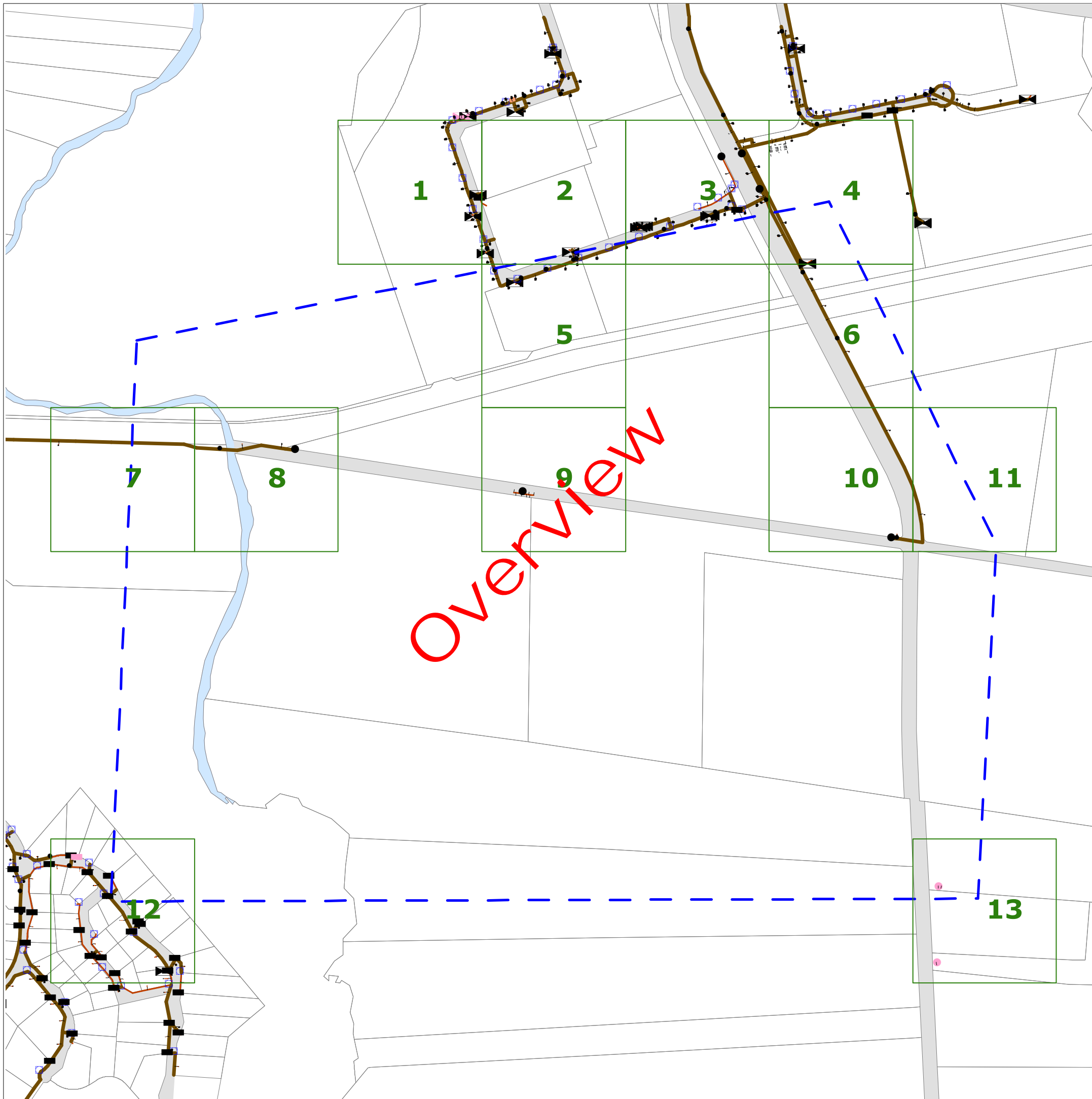

WARNING

- **All electrical apparatus shall be regarded as live until proved de-energised.** Contact with live electrical apparatus will cause severe injury or death.
- In accordance with the *Electricity Supply Act 1995*, you are obliged to report any damage to Endeavour Energy Assets immediately by calling **131 003**.
- The customer must obtain a new set of plans from Endeavour Energy if work has not been started or completed within twenty (20) working days of the original plan issue date.
- The customer must contact Endeavour Energy if any of the plans provided have blank pages, as some underground asset information may be incomplete.
- Endeavour Energy underground earth grids may exist and their location **may not** be shown on plans. Persons excavating are expected to exercise all due care, especially in the vicinity of padmount substations, pole mounted substations, pole mounted switches, transmission poles and towers.
- Endeavour Energy plans **do not** show any underground customer service mains or information relating to service mains within private property.
- Asbestos or asbestos-containing material may be present on or near Endeavour Energy's underground assets.
- Organo-Chloride Pesticides (OCP) may be present in some sub-transmission trenches.
- All plans must be printed and made available at the worksite where excavation is to be undertaken. Plans must be reviewed and understood by the crew on site prior to commencing excavation.











INFORMATION PROVIDED BY ENDEAVOUR ENERGY

- Any plans provided pursuant to this service are intended to show the approximate location of underground assets relative to road boundaries, property fences and other structures at the time of installation.
- Depth of underground assets may vary significantly from information provided on plans as a result of changes to road, footpath or surface levels subsequent to installation.
- Such plans have been prepared solely for use by Endeavour Energy staff for design, construction and maintenance purposes.
- All enquiry details and results are kept in a register.

DISCLAIMER

Whilst Endeavour Energy has taken all reasonable steps to ensure that the information contained in the plans is as accurate as possible it will accept no liability for inaccuracies in the information shown on such plans.

LEGEND

-  or  Street light column
-  Padmount substation
-  or  Overground pillar (O.G.Box)
-  Underground pit
-  Duct run
-  Cable run
-  Typical duct section
-  Asbestos warning



NOT TO SCALE

DBYD Sequence No.:	105300013
Issued Date:	07/01/2021

1

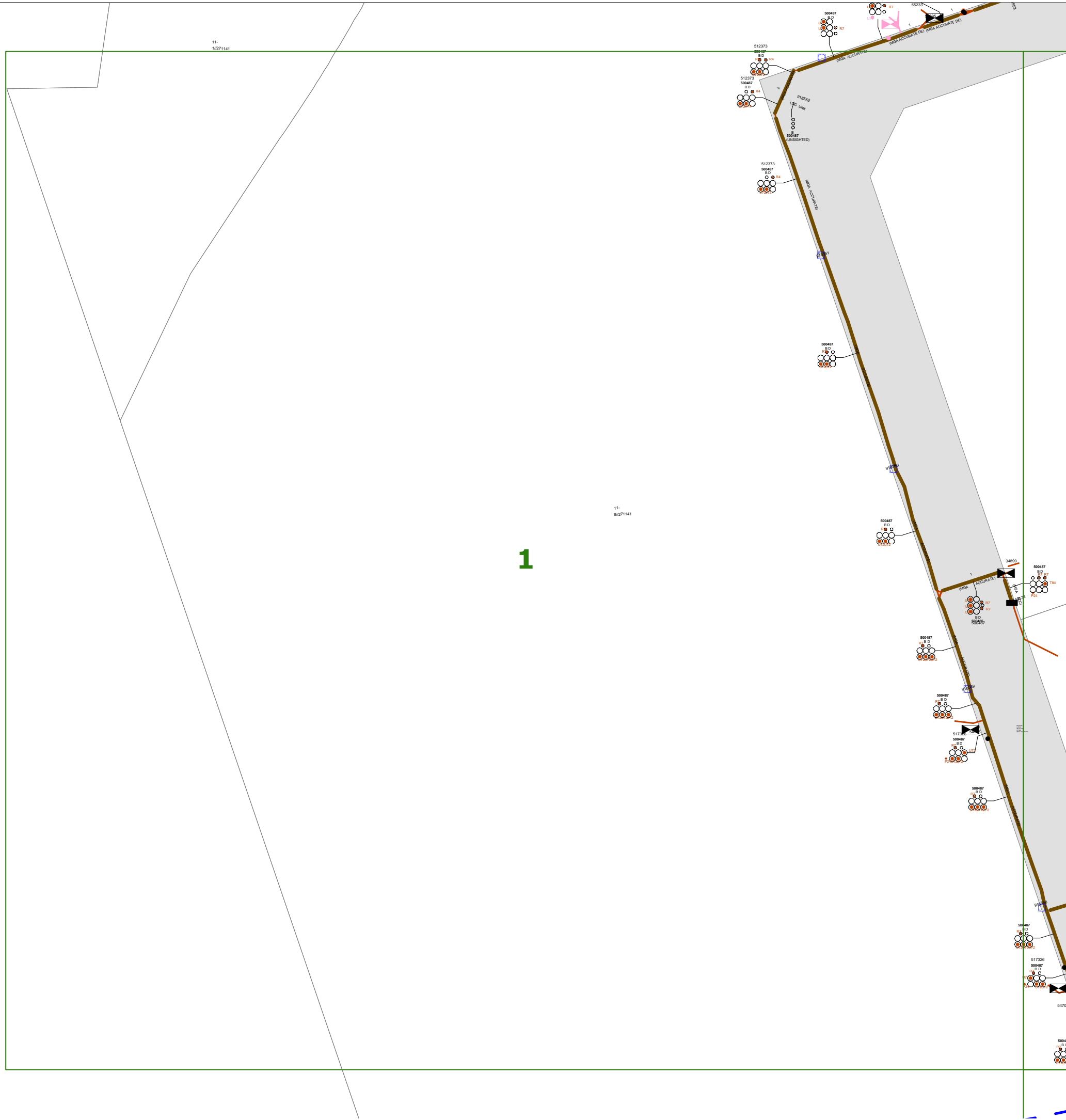

WARNING

- **All electrical apparatus shall be regarded as live until proved de-energised.** Contact with live electrical apparatus will cause severe injury or death.
- In accordance with the *Electricity Supply Act 1995*, you are obliged to report any damage to Endeavour Energy Assets immediately by calling **131 003**.
- The customer must obtain a new set of plans from Endeavour Energy if work has not been started or completed within twenty (20) working days of the original plan issue date.
- The customer must contact Endeavour Energy if any of the plans provided have blank pages, as some underground asset information may be incomplete.
- Endeavour Energy underground earth grids may exist and their location **may not** be shown on plans. Persons excavating are expected to exercise all due care, especially in the vicinity of padmount substations, pole mounted substations, pole mounted switches, transmission poles and towers.
- Endeavour Energy plans **do not** show any underground customer service mains or information relating to service mains within private property.
- Asbestos or asbestos-containing material may be present on or near Endeavour Energy's underground assets.
- Organo-Chloride Pesticides (OCP) may be present in some sub-transmission trenches.
- All plans must be printed and made available at the worksite where excavation is to be undertaken. Plans must be reviewed and understood by the crew on site prior to commencing excavation.











INFORMATION PROVIDED BY ENDEAVOUR ENERGY

- Any plans provided pursuant to this service are intended to show the approximate location of underground assets relative to road boundaries, property fences and other structures at the time of installation.
- Depth of underground assets may vary significantly from information provided on plans as a result of changes to road, footpath or surface levels subsequent to installation.
- Such plans have been prepared solely for use by Endeavour Energy staff for design, construction and maintenance purposes.
- All enquiry details and results are kept in a register.

DISCLAIMER

Whilst Endeavour Energy has taken all reasonable steps to ensure that the information contained in the plans is as accurate as possible it will accept no liability for inaccuracies in the information shown on such plans.

LEGEND

-  or  Street light column
-  Padmount substation
-  or  Overground pillar (O.G.Box)
-  Underground pit
-  Duct run
-  Cable run
-  Typical duct section
-  Asbestos warning



NOT TO SCALE

DBYD Sequence No.:	105300013
Issued Date:	07/01/2021

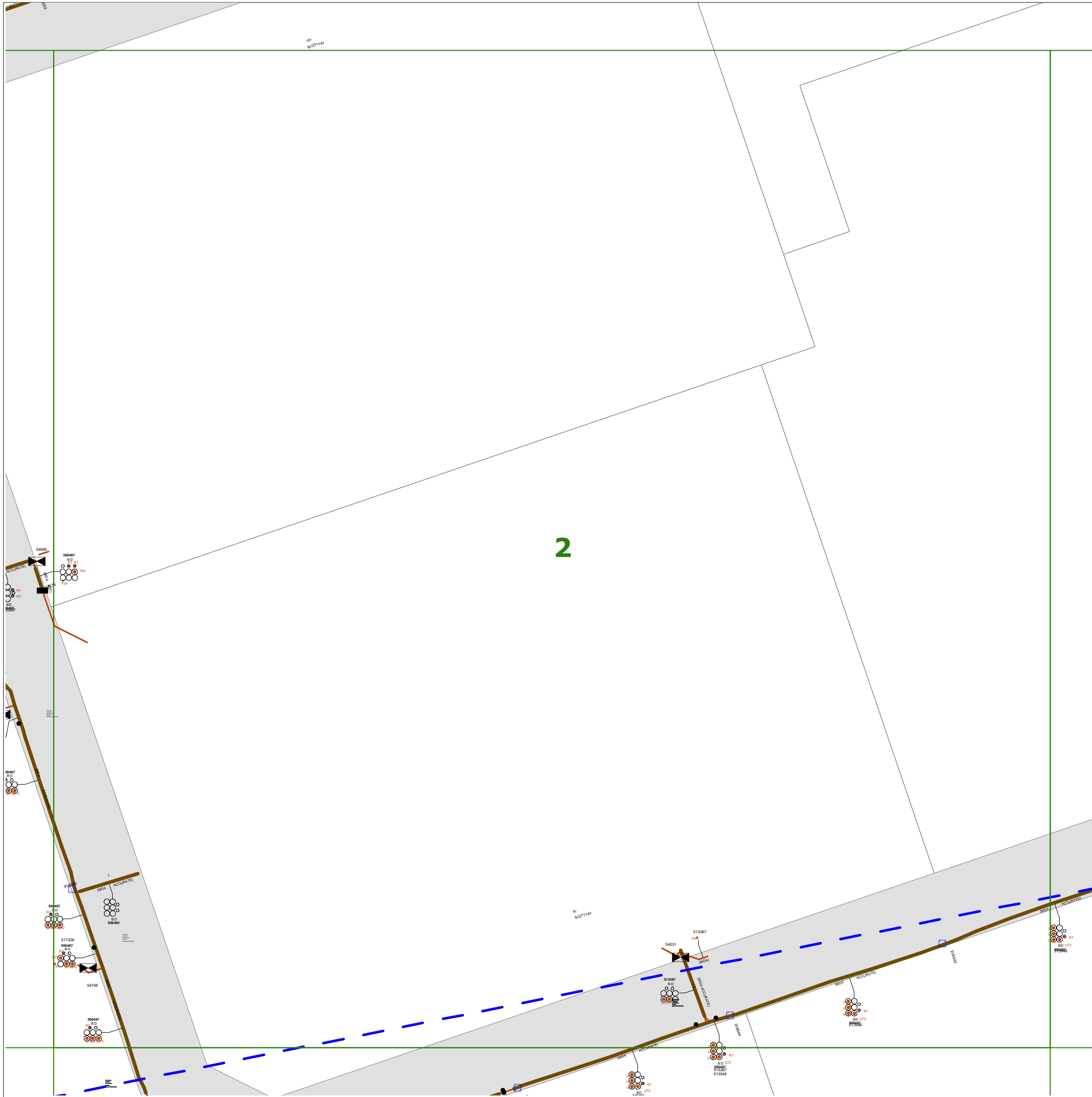

WARNING

- **All electrical apparatus shall be regarded as live until proved de-energised.** Contact with live electrical apparatus will cause severe injury or death.
- In accordance with the *Electricity Supply Act 1995*, you are obliged to report any damage to Endeavour Energy Assets immediately by calling **131 003**.
- The customer must obtain a new set of plans from Endeavour Energy if work has not been started or completed within twenty (20) working days of the original plan issue date.
- The customer must contact Endeavour Energy if any of the plans provided have blank pages, as some underground asset information may be incomplete.
- Endeavour Energy underground earth grids may exist and their location **may not** be shown on plans. Persons excavating are expected to exercise all due care, especially in the vicinity of padmount substations, pole mounted substations, pole mounted switches, transmission poles and towers.
- Endeavour Energy plans **do not** show any underground customer service mains or information relating to service mains within private property.
- Asbestos or asbestos-containing material may be present on or near Endeavour Energy's underground assets.
- Organo-Chloride Pesticides (OCP) may be present in some sub-transmission trenches.
- All plans must be printed and made available at the worksite where excavation is to be undertaken. Plans must be reviewed and understood by the crew on site prior to commencing excavation.











INFORMATION PROVIDED BY ENDEAVOUR ENERGY

- Any plans provided pursuant to this service are intended to show the approximate location of underground assets relative to road boundaries, property fences and other structures at the time of installation.
- Depth of underground assets may vary significantly from information provided on plans as a result of changes to road, footpath or surface levels subsequent to installation.
- Such plans have been prepared solely for use by Endeavour Energy staff for design, construction and maintenance purposes.
- All enquiry details and results are kept in a register.

DISCLAIMER

Whilst Endeavour Energy has taken all reasonable steps to ensure that the information contained in the plans is as accurate as possible it will accept no liability for inaccuracies in the information shown on such plans.

LEGEND

-  OR  Street light column
-  Padmount substation
-  OR  Overground pillar (O.G.Box)
-  Underground pit
-  Duct run
-  Cable run
-  Typical duct section
-  Asbestos warning



NOT TO SCALE

DBYD Sequence No.:	105300013
Issued Date:	07/01/2021

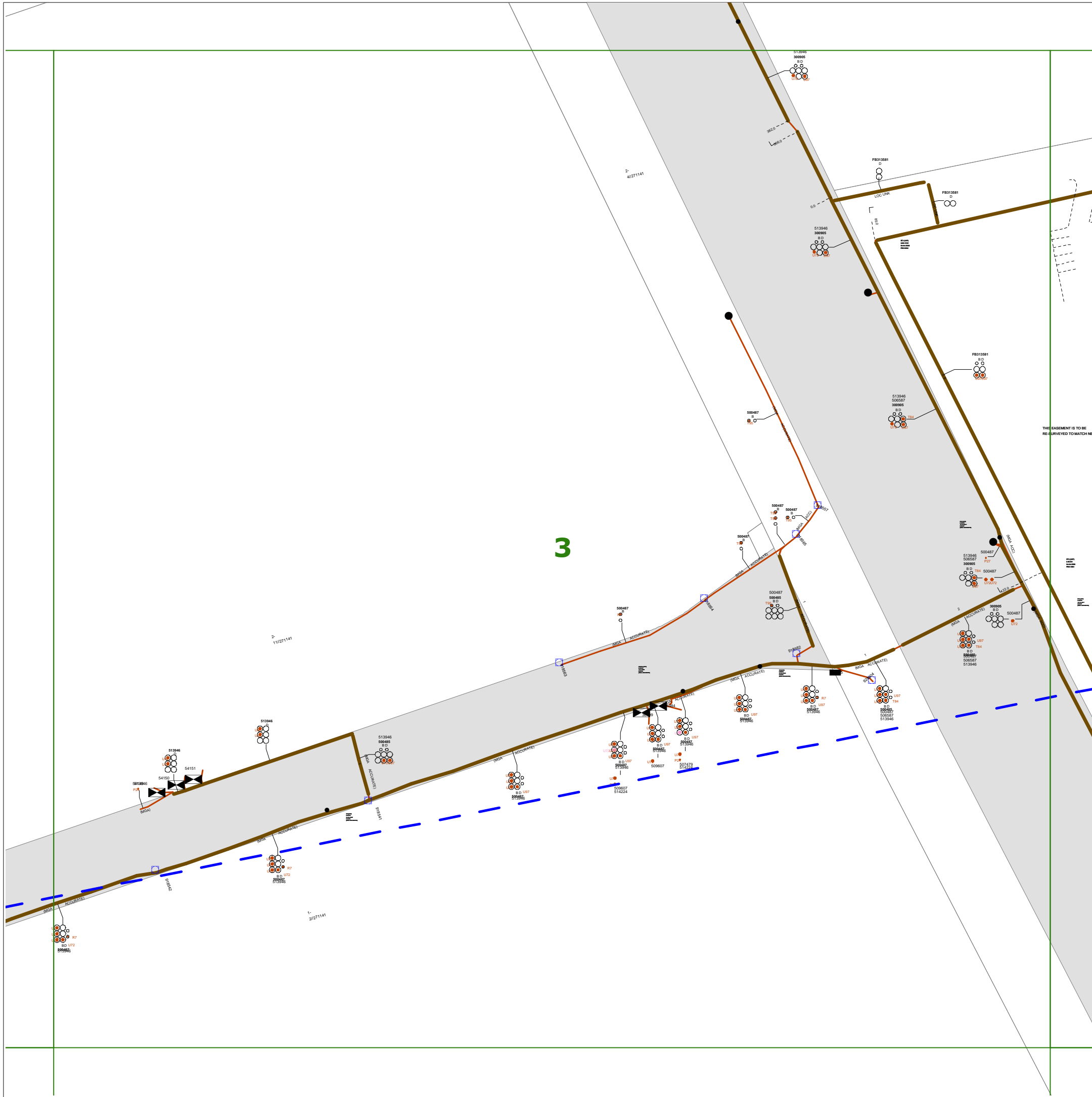

WARNING

- **All electrical apparatus shall be regarded as live until proved de-energised.** Contact with live electrical apparatus will cause severe injury or death.
- In accordance with the *Electricity Supply Act 1995*, you are obliged to report any damage to Endeavour Energy Assets immediately by calling **131 003**.
- The customer must obtain a new set of plans from Endeavour Energy if work has not been started or completed within twenty (20) working days of the original plan issue date.
- The customer must contact Endeavour Energy if any of the plans provided have blank pages, as some underground asset information may be incomplete.
- Endeavour Energy underground earth grids may exist and their location **may not** be shown on plans. Persons excavating are expected to exercise all due care, especially in the vicinity of padmount substations, pole mounted substations, pole mounted switches, transmission poles and towers.
- Endeavour Energy plans **do not** show any underground customer service mains or information relating to service mains within private property.
- Asbestos or asbestos-containing material may be present on or near Endeavour Energy's underground assets.
- Organo-Chloride Pesticides (OCP) may be present in some sub-transmission trenches.
- All plans must be printed and made available at the worksite where excavation is to be undertaken. Plans must be reviewed and understood by the crew on site prior to commencing excavation.











INFORMATION PROVIDED BY ENDEAVOUR ENERGY

- Any plans provided pursuant to this service are intended to show the approximate location of underground assets relative to road boundaries, property fences and other structures at the time of installation.
- Depth of underground assets may vary significantly from information provided on plans as a result of changes to road, footpath or surface levels subsequent to installation.
- Such plans have been prepared solely for use by Endeavour Energy staff for design, construction and maintenance purposes.
- All enquiry details and results are kept in a register.

DISCLAIMER

Whilst Endeavour Energy has taken all reasonable steps to ensure that the information contained in the plans is as accurate as possible it will accept no liability for inaccuracies in the information shown on such plans.

LEGEND

-  OR  Street light column
-  Padmount substation
-  OR  Overground pillar (O.G.Box)
-  Underground pit
-  Duct run
-  Cable run
-  Typical duct section
-  Asbestos warning



NOT TO SCALE

DBYD Sequence No.:	105300013
Issued Date:	07/01/2021

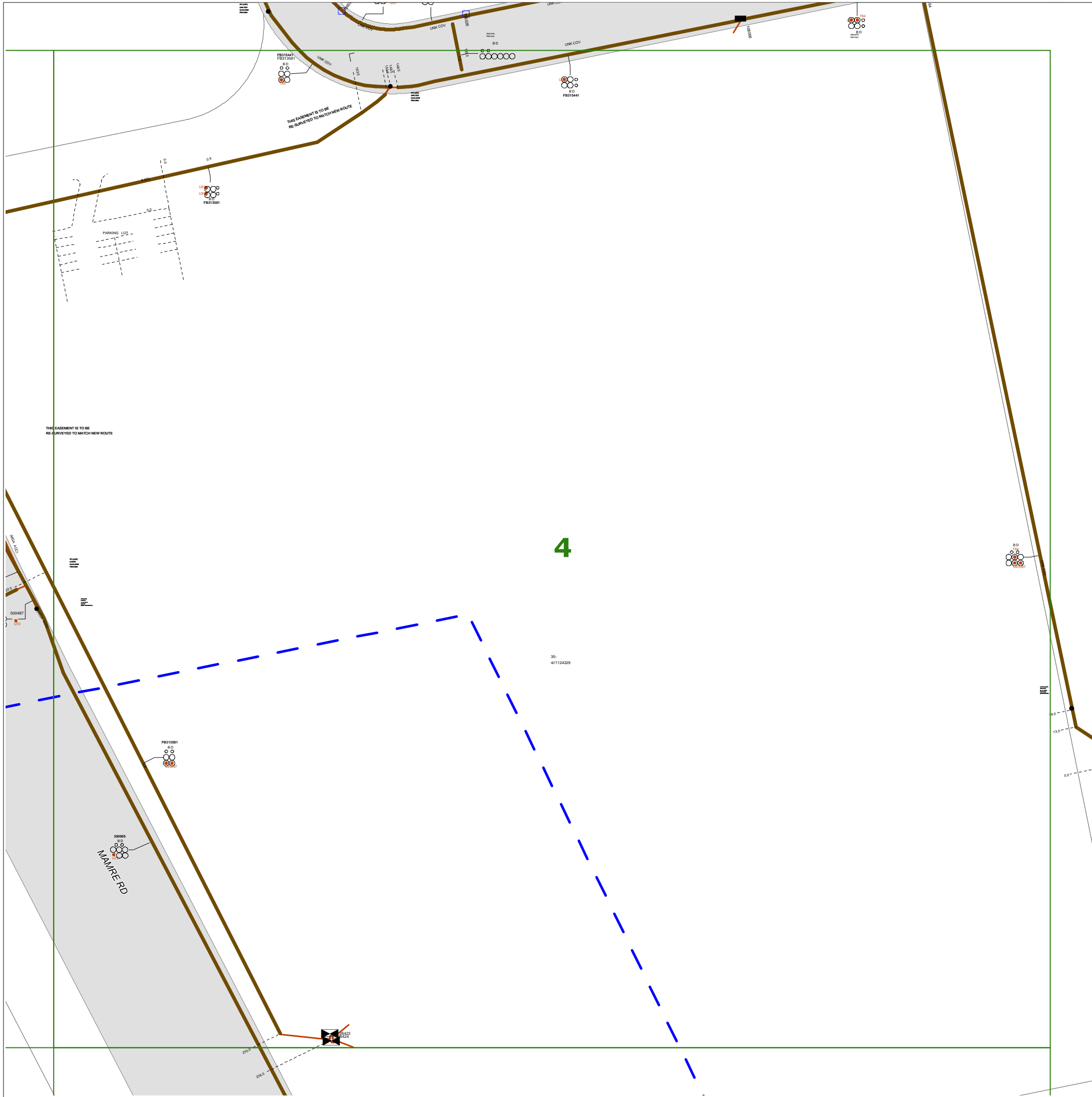

WARNING

- **All electrical apparatus shall be regarded as live until proved de-energised.** Contact with live electrical apparatus will cause severe injury or death.
- In accordance with the *Electricity Supply Act 1995*, you are obliged to report any damage to Endeavour Energy Assets immediately by calling **131 003**.
- The customer must obtain a new set of plans from Endeavour Energy if work has not been started or completed within twenty (20) working days of the original plan issue date.
- The customer must contact Endeavour Energy if any of the plans provided have blank pages, as some underground asset information may be incomplete.
- Endeavour Energy underground earth grids may exist and their location **may not** be shown on plans. Persons excavating are expected to exercise all due care, especially in the vicinity of padmount substations, pole mounted substations, pole mounted switches, transmission poles and towers.
- Endeavour Energy plans **do not** show any underground customer service mains or information relating to service mains within private property.
- Asbestos or asbestos-containing material may be present on or near Endeavour Energy's underground assets.
- Organo-Chloride Pesticides (OCP) may be present in some sub-transmission trenches.
- All plans must be printed and made available at the worksite where excavation is to be undertaken. Plans must be reviewed and understood by the crew on site prior to commencing excavation.

INFORMATION PROVIDED BY ENDEAVOUR ENERGY

- Any plans provided pursuant to this service are intended to show the approximate location of underground assets relative to road boundaries, property fences and other structures at the time of installation.
- Depth of underground assets may vary significantly from information provided on plans as a result of changes to road, footpath or surface levels subsequent to installation.
- Such plans have been prepared solely for use by Endeavour Energy staff for design, construction and maintenance purposes.
- All enquiry details and results are kept in a register.

DISCLAIMER

Whilst Endeavour Energy has taken all reasonable steps to ensure that the information contained in the plans is as accurate as possible it will accept no liability for inaccuracies in the information shown on such plans.

LEGEND

- OR ■ Street light column
- ▭ Padmount substation
- OR ■ Overground pillar (O.G.Box)
- ▭ Underground pit
- ▬ Duct run
- ▬ Cable run
- ⊙ Typical duct section
- ▲ Asbestos warning



NOT TO SCALE

DBYD Sequence No.:	105300013
Issued Date:	07/01/2021

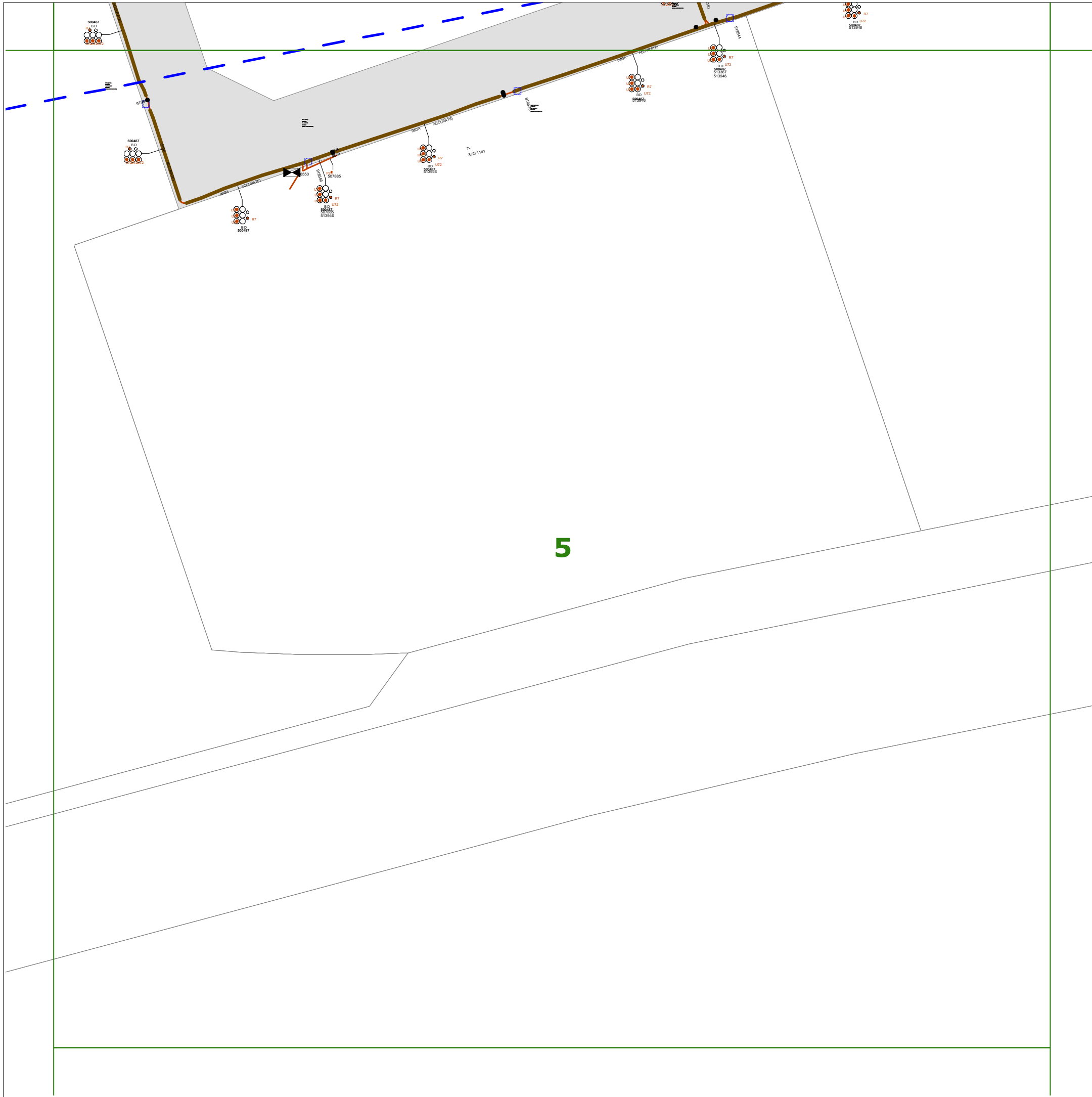

WARNING

- **All electrical apparatus shall be regarded as live until proved de-energised.** Contact with live electrical apparatus will cause severe injury or death.
- In accordance with the *Electricity Supply Act 1995*, you are obliged to report any damage to Endeavour Energy Assets immediately by calling **131 003**.
- The customer must obtain a new set of plans from Endeavour Energy if work has not been started or completed within twenty (20) working days of the original plan issue date.
- The customer must contact Endeavour Energy if any of the plans provided have blank pages, as some underground asset information may be incomplete.
- Endeavour Energy underground earth grids may exist and their location **may not** be shown on plans. Persons excavating are expected to exercise all due care, especially in the vicinity of padmount substations, pole mounted substations, pole mounted switches, transmission poles and towers.
- Endeavour Energy plans **do not** show any underground customer service mains or information relating to service mains within private property.
- Asbestos or asbestos-containing material may be present on or near Endeavour Energy's underground assets.
- Organo-Chloride Pesticides (OCP) may be present in some sub-transmission trenches.
- All plans must be printed and made available at the worksite where excavation is to be undertaken. Plans must be reviewed and understood by the crew on site prior to commencing excavation.

INFORMATION PROVIDED BY ENDEAVOUR ENERGY

- Any plans provided pursuant to this service are intended to show the approximate location of underground assets relative to road boundaries, property fences and other structures at the time of installation.
- Depth of underground assets may vary significantly from information provided on plans as a result of changes to road, footpath or surface levels subsequent to installation.
- Such plans have been prepared solely for use by Endeavour Energy staff for design, construction and maintenance purposes.
- All enquiry details and results are kept in a register.

DISCLAIMER

Whilst Endeavour Energy has taken all reasonable steps to ensure that the information contained in the plans is as accurate as possible it will accept no liability for inaccuracies in the information shown on such plans.

LEGEND

- or ■ Street light column
- ▭ Padmount substation
- or ■ Overground pillar (O.G.Box)
- ▭ Underground pit
- ▬ Duct run
- ▬ Cable run
- ⊙ Typical duct section
- ▲ Asbestos warning



NOT TO SCALE

DBYD Sequence No.:	105300013
Issued Date:	07/01/2021

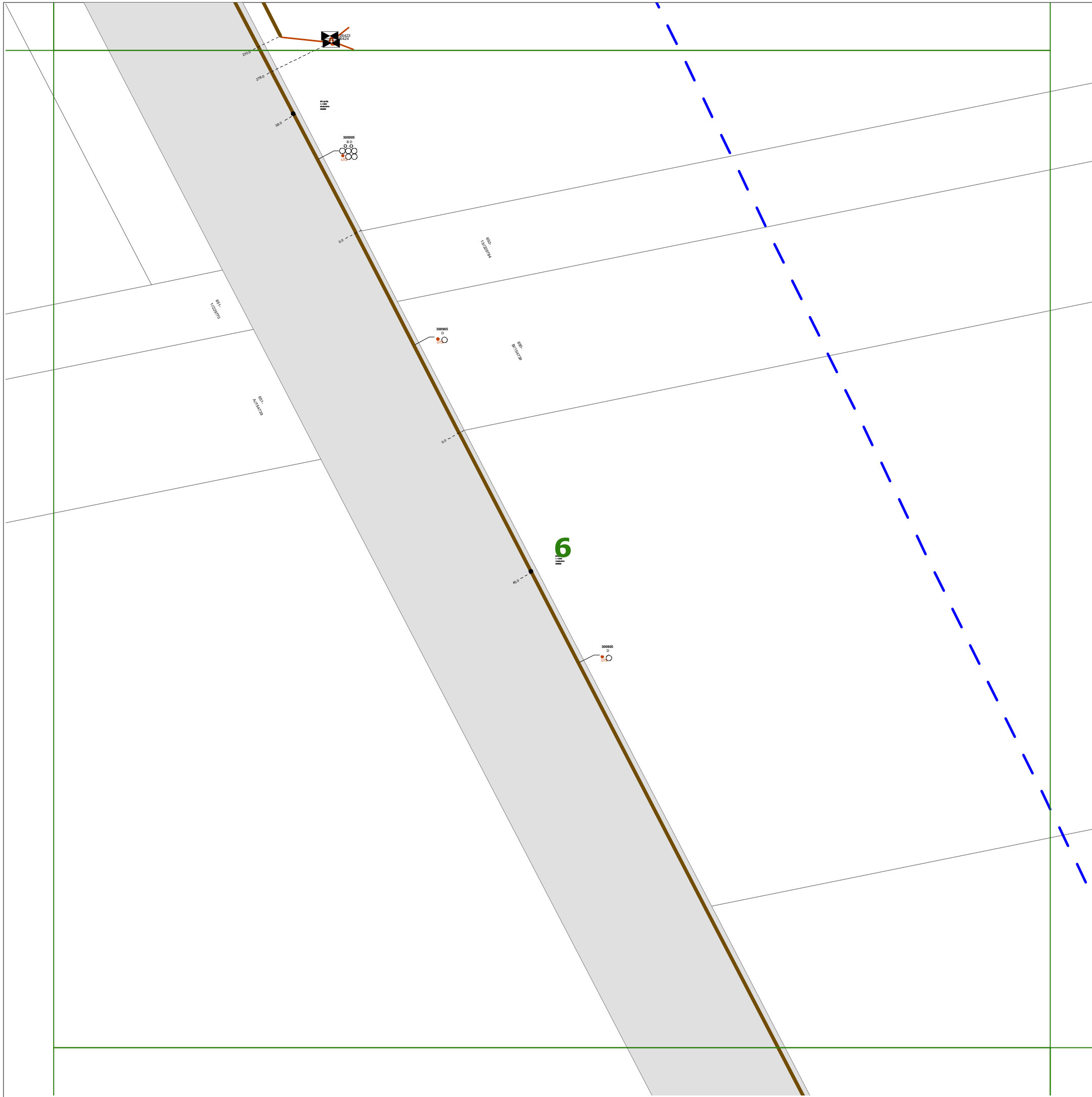

WARNING

- **All electrical apparatus shall be regarded as live until proved de-energised.** Contact with live electrical apparatus will cause severe injury or death.
- In accordance with the *Electricity Supply Act 1995*, you are obliged to report any damage to Endeavour Energy Assets immediately by calling **131 003**.
- The customer must obtain a new set of plans from Endeavour Energy if work has not been started or completed within twenty (20) working days of the original plan issue date.
- The customer must contact Endeavour Energy if any of the plans provided have blank pages, as some underground asset information may be incomplete.
- Endeavour Energy underground earth grids may exist and their location **may not** be shown on plans. Persons excavating are expected to exercise all due care, especially in the vicinity of padmount substations, pole mounted substations, pole mounted switches, transmission poles and towers.
- Endeavour Energy plans **do not** show any underground customer service mains or information relating to service mains within private property.
- Asbestos or asbestos-containing material may be present on or near Endeavour Energy's underground assets.
- Organo-Chloride Pesticides (OCP) may be present in some sub-transmission trenches.
- All plans must be printed and made available at the worksite where excavation is to be undertaken. Plans must be reviewed and understood by the crew on site prior to commencing excavation.

INFORMATION PROVIDED BY ENDEAVOUR ENERGY

- Any plans provided pursuant to this service are intended to show the approximate location of underground assets relative to road boundaries, property fences and other structures at the time of installation.
- Depth of underground assets may vary significantly from information provided on plans as a result of changes to road, footpath or surface levels subsequent to installation.
- Such plans have been prepared solely for use by Endeavour Energy staff for design, construction and maintenance purposes.
- All enquiry details and results are kept in a register.

DISCLAIMER

Whilst Endeavour Energy has taken all reasonable steps to ensure that the information contained in the plans is as accurate as possible it will accept no liability for inaccuracies in the information shown on such plans.

LEGEND

- or ■ Street light column
- ▭ Padmount substation
- or ■ Overground pillar (O.G.Box)
- ▭ Underground pit
- Duct run
- Cable run
- ⊙ Typical duct section
- ▲ Asbestos warning



NOT TO SCALE

DBYD Sequence No.:	105300013
Issued Date:	07/01/2021

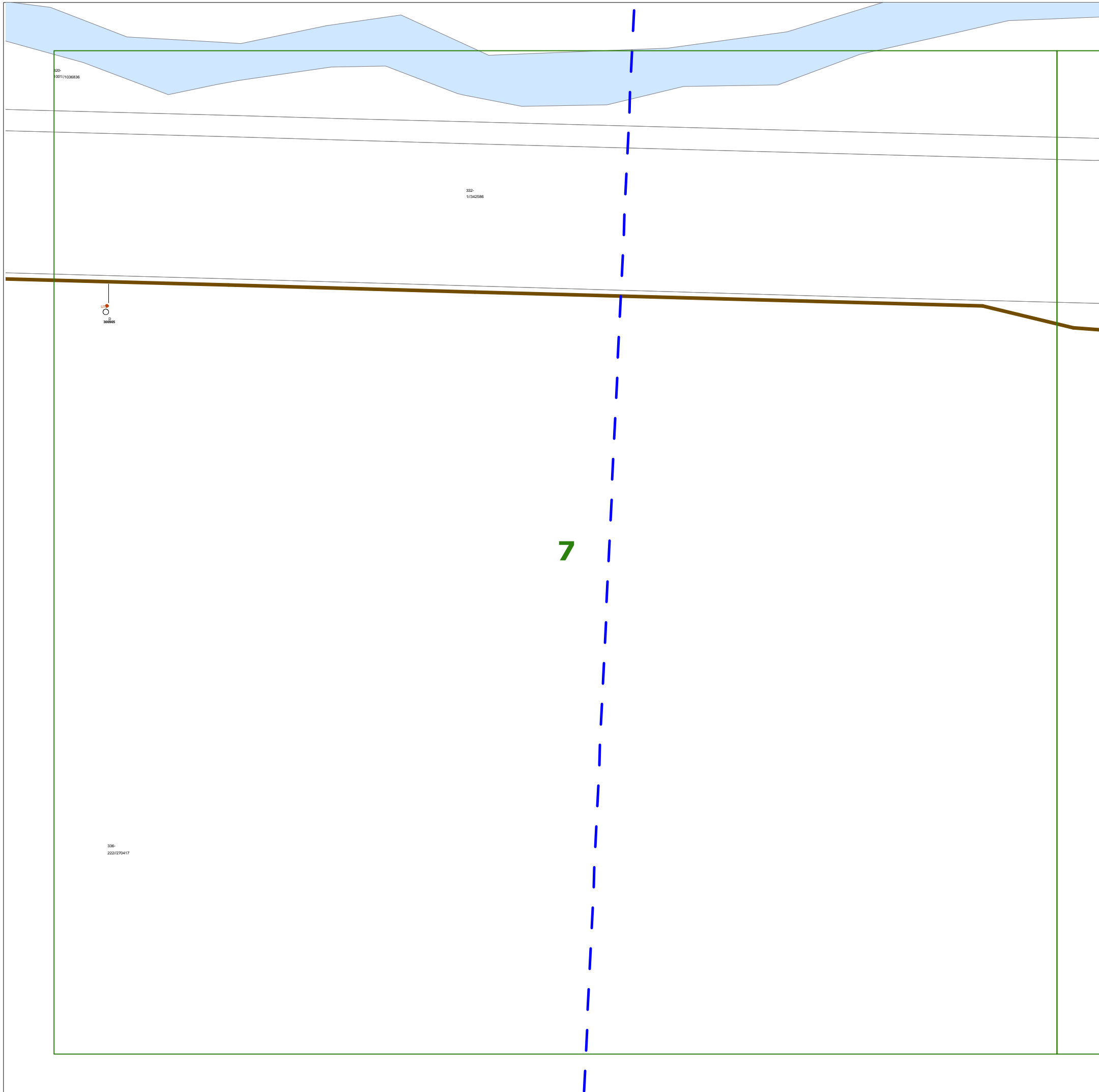

WARNING

- **All electrical apparatus shall be regarded as live until proved de-energised.** Contact with live electrical apparatus will cause severe injury or death.
- In accordance with the *Electricity Supply Act 1995*, you are obliged to report any damage to Endeavour Energy Assets immediately by calling **131 003**.
- The customer must obtain a new set of plans from Endeavour Energy if work has not been started or completed within twenty (20) working days of the original plan issue date.
- The customer must contact Endeavour Energy if any of the plans provided have blank pages, as some underground asset information may be incomplete.
- Endeavour Energy underground earth grids may exist and their location **may not** be shown on plans. Persons excavating are expected to exercise all due care, especially in the vicinity of padmount substations, pole mounted substations, pole mounted switches, transmission poles and towers.
- Endeavour Energy plans **do not** show any underground customer service mains or information relating to service mains within private property.
- Asbestos or asbestos-containing material may be present on or near Endeavour Energy's underground assets.
- Organo-Chloride Pesticides (OCP) may be present in some sub-transmission trenches.
- All plans must be printed and made available at the worksite where excavation is to be undertaken. Plans must be reviewed and understood by the crew on site prior to commencing excavation.

INFORMATION PROVIDED BY ENDEAVOUR ENERGY

- Any plans provided pursuant to this service are intended to show the approximate location of underground assets relative to road boundaries, property fences and other structures at the time of installation.
- Depth of underground assets may vary significantly from information provided on plans as a result of changes to road, footpath or surface levels subsequent to installation.
- Such plans have been prepared solely for use by Endeavour Energy staff for design, construction and maintenance purposes.
- All enquiry details and results are kept in a register.

DISCLAIMER

Whilst Endeavour Energy has taken all reasonable steps to ensure that the information contained in the plans is as accurate as possible it will accept no liability for inaccuracies in the information shown on such plans.

LEGEND

- or ■ Street light column
- ▭ Padmount substation
- or ■ Overground pillar (O.G.Box)
- ▭ Underground pit
- ▬ Duct run
- ▬ Cable run
- ⊙ Typical duct section
- ▲ Asbestos warning



NOT TO SCALE

DBYD Sequence No.:	105300013
Issued Date:	07/01/2021

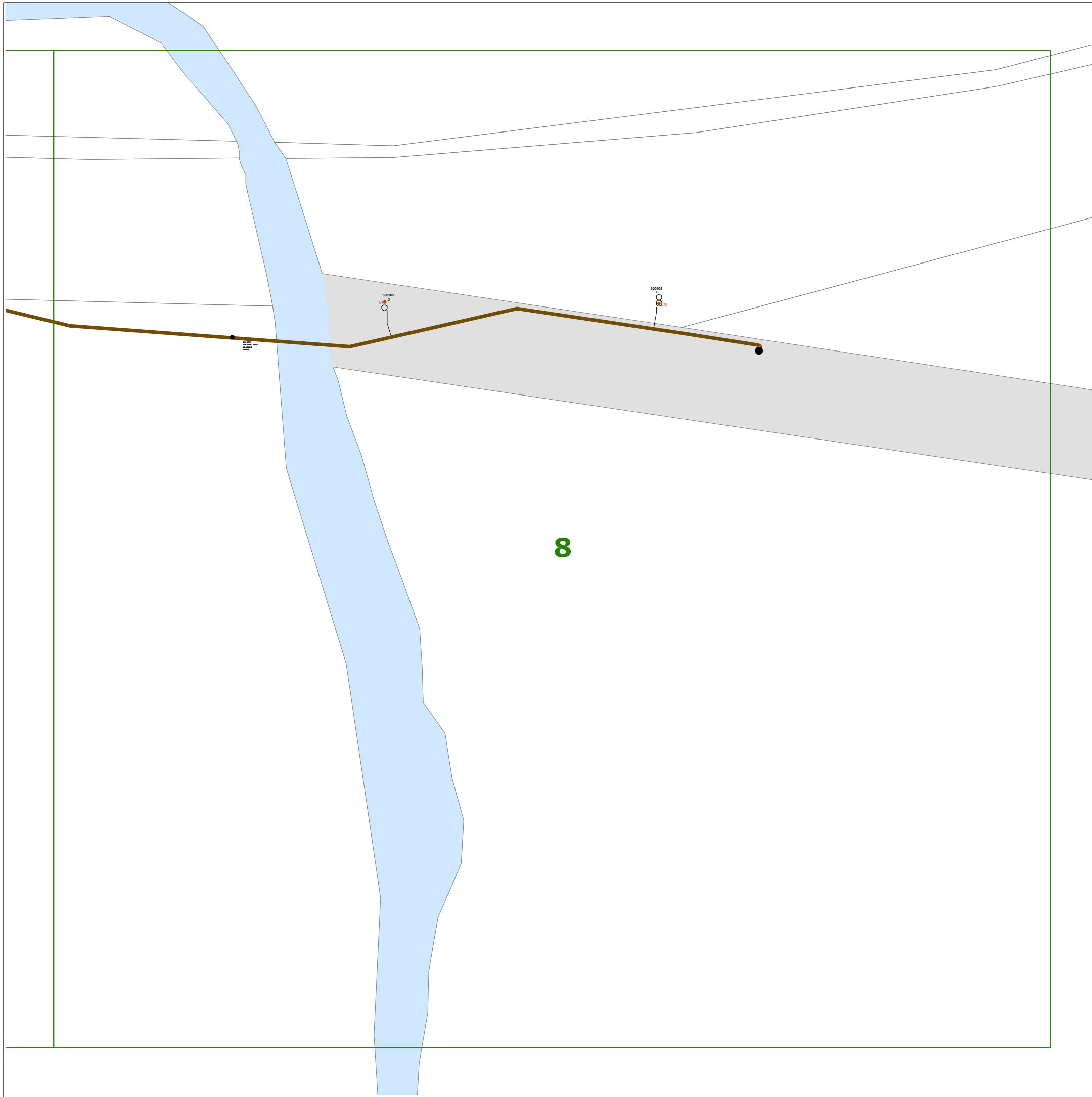

WARNING

- **All electrical apparatus shall be regarded as live until proved de-energised.** Contact with live electrical apparatus will cause severe injury or death.
- In accordance with the *Electricity Supply Act 1995*, you are obliged to report any damage to Endeavour Energy Assets immediately by calling **131 003**.
- The customer must obtain a new set of plans from Endeavour Energy if work has not been started or completed within twenty (20) working days of the original plan issue date.
- The customer must contact Endeavour Energy if any of the plans provided have blank pages, as some underground asset information may be incomplete.
- Endeavour Energy underground earth grids may exist and their location **may not** be shown on plans. Persons excavating are expected to exercise all due care, especially in the vicinity of padmount substations, pole mounted substations, pole mounted switches, transmission poles and towers.
- Endeavour Energy plans **do not** show any underground customer service mains or information relating to service mains within private property.
- Asbestos or asbestos-containing material may be present on or near Endeavour Energy's underground assets.
- Organo-Chloride Pesticides (OCP) may be present in some sub-transmission trenches.
- All plans must be printed and made available at the worksite where excavation is to be undertaken. Plans must be reviewed and understood by the crew on site prior to commencing excavation.

INFORMATION PROVIDED BY ENDEAVOUR ENERGY

- Any plans provided pursuant to this service are intended to show the approximate location of underground assets relative to road boundaries, property fences and other structures at the time of installation.
- Depth of underground assets may vary significantly from information provided on plans as a result of changes to road, footpath or surface levels subsequent to installation.
- Such plans have been prepared solely for use by Endeavour Energy staff for design, construction and maintenance purposes.
- All enquiry details and results are kept in a register.

DISCLAIMER

Whilst Endeavour Energy has taken all reasonable steps to ensure that the information contained in the plans is as accurate as possible it will accept no liability for inaccuracies in the information shown on such plans.

LEGEND

- or ■ Street light column
- ▭ Padmount substation
- or ■ Overground pillar (O.G.Box)
- ▭ Underground pit
- ▬ Duct run
- ▬ Cable run
- ⊙ Typical duct section
- ▲ Asbestos warning



NOT TO SCALE

DBYD Sequence No.:	105300013
Issued Date:	07/01/2021

9

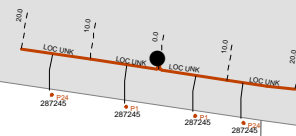

WARNING

- **All electrical apparatus shall be regarded as live until proved de-energised.** Contact with live electrical apparatus will cause severe injury or death.
- In accordance with the *Electricity Supply Act 1995*, you are obliged to report any damage to Endeavour Energy Assets immediately by calling **131 003**.
- The customer must obtain a new set of plans from Endeavour Energy if work has not been started or completed within twenty (20) working days of the original plan issue date.
- The customer must contact Endeavour Energy if any of the plans provided have blank pages, as some underground asset information may be incomplete.
- Endeavour Energy underground earth grids may exist and their location **may not** be shown on plans. Persons excavating are expected to exercise all due care, especially in the vicinity of padmount substations, pole mounted substations, pole mounted switches, transmission poles and towers.
- Endeavour Energy plans **do not** show any underground customer service mains or information relating to service mains within private property.
- Asbestos or asbestos-containing material may be present on or near Endeavour Energy's underground assets.
- Organo-Chloride Pesticides (OCP) may be present in some sub-transmission trenches.
- All plans must be printed and made available at the worksite where excavation is to be undertaken. Plans must be reviewed and understood by the crew on site prior to commencing excavation.

INFORMATION PROVIDED BY ENDEAVOUR ENERGY

- Any plans provided pursuant to this service are intended to show the approximate location of underground assets relative to road boundaries, property fences and other structures at the time of installation.
- Depth of underground assets may vary significantly from information provided on plans as a result of changes to road, footpath or surface levels subsequent to installation.
- Such plans have been prepared solely for use by Endeavour Energy staff for design, construction and maintenance purposes.
- All enquiry details and results are kept in a register.

DISCLAIMER

Whilst Endeavour Energy has taken all reasonable steps to ensure that the information contained in the plans is as accurate as possible it will accept no liability for inaccuracies in the information shown on such plans.

LEGEND

- or ■ Street light column
- ▭ Padmount substation
- or ■ Overground pillar (O.G.Box)
- ▭ Underground pit
- Duct run
- Cable run
- ⊙ Typical duct section
- ▲ Asbestos warning



NOT TO SCALE

DBYD Sequence No.:	105300013
Issued Date:	07/01/2021

10

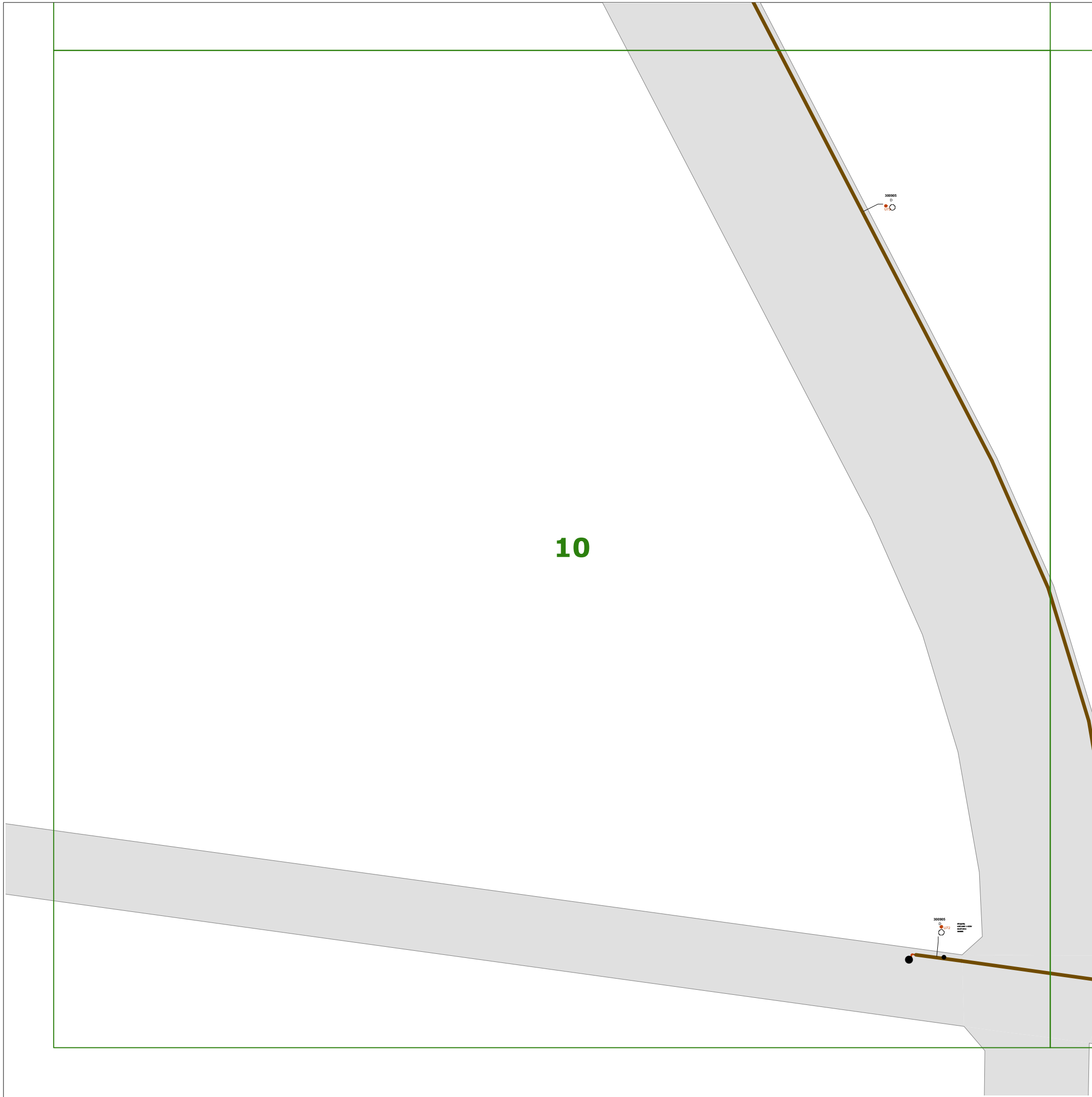

WARNING

- **All electrical apparatus shall be regarded as live until proved de-energised.** Contact with live electrical apparatus will cause severe injury or death.
- In accordance with the *Electricity Supply Act 1995*, you are obliged to report any damage to Endeavour Energy Assets immediately by calling **131 003**.
- The customer must obtain a new set of plans from Endeavour Energy if work has not been started or completed within twenty (20) working days of the original plan issue date.
- The customer must contact Endeavour Energy if any of the plans provided have blank pages, as some underground asset information may be incomplete.
- Endeavour Energy underground earth grids may exist and their location **may not** be shown on plans. Persons excavating are expected to exercise all due care, especially in the vicinity of padmount substations, pole mounted substations, pole mounted switches, transmission poles and towers.
- Endeavour Energy plans **do not** show any underground customer service mains or information relating to service mains within private property.
- Asbestos or asbestos-containing material may be present on or near Endeavour Energy's underground assets.
- Organo-Chloride Pesticides (OCP) may be present in some sub-transmission trenches.
- All plans must be printed and made available at the worksite where excavation is to be undertaken. Plans must be reviewed and understood by the crew on site prior to commencing excavation.

INFORMATION PROVIDED BY ENDEAVOUR ENERGY

- Any plans provided pursuant to this service are intended to show the approximate location of underground assets relative to road boundaries, property fences and other structures at the time of installation.
- Depth of underground assets may vary significantly from information provided on plans as a result of changes to road, footpath or surface levels subsequent to installation.
- Such plans have been prepared solely for use by Endeavour Energy staff for design, construction and maintenance purposes.
- All enquiry details and results are kept in a register.

DISCLAIMER

Whilst Endeavour Energy has taken all reasonable steps to ensure that the information contained in the plans is as accurate as possible it will accept no liability for inaccuracies in the information shown on such plans.

LEGEND

- or ■ Street light column
- ▭ Padmount substation
- or ■ Overground pillar (O.G.Box)
- ▭ Underground pit
- Duct run
- Cable run
- ⊙ Typical duct section
- ▲ Asbestos warning



NOT TO SCALE

DBYD Sequence No.:	105300013
Issued Date:	07/01/2021

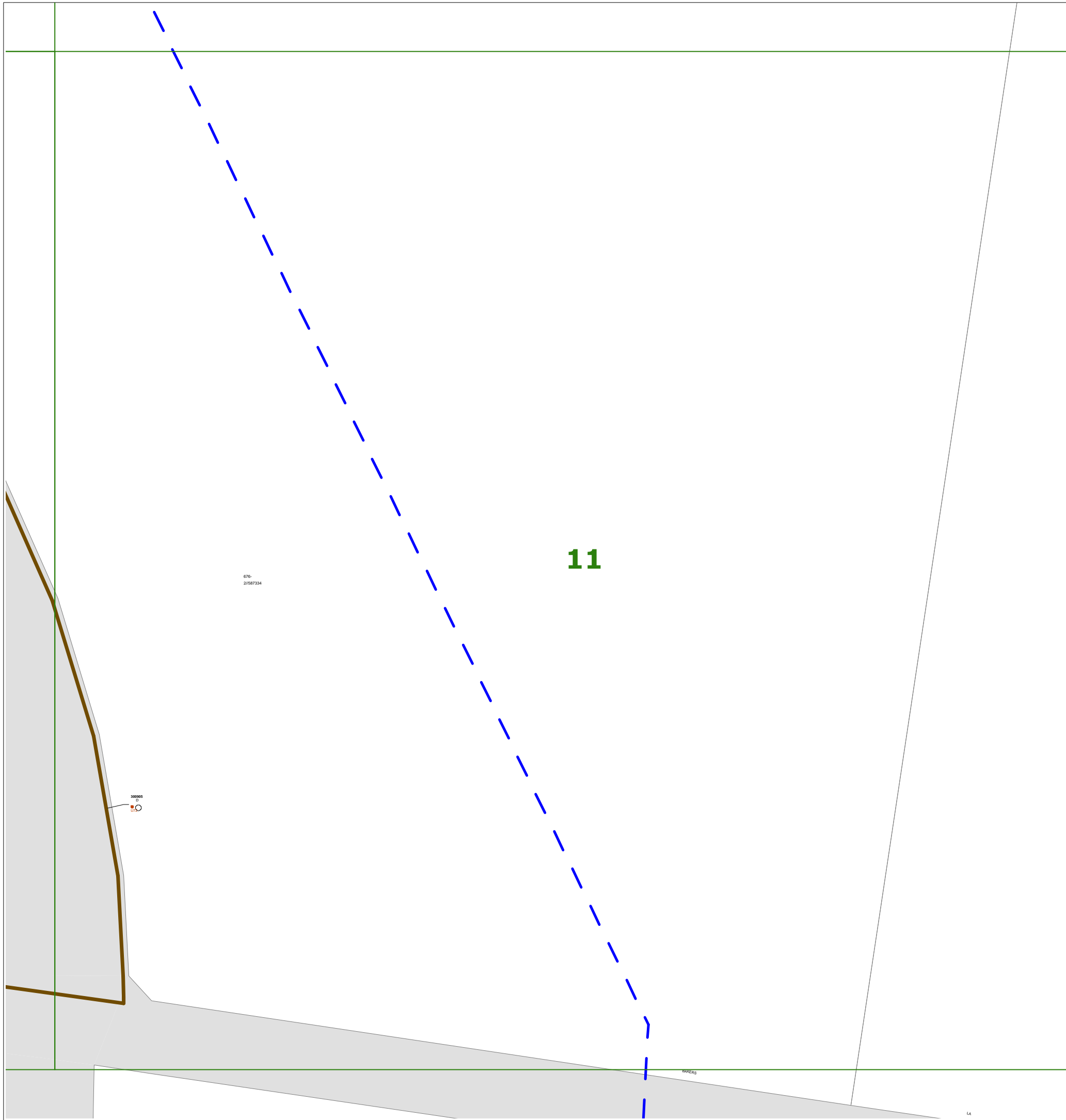

WARNING

- **All electrical apparatus shall be regarded as live until proved de-energised.** Contact with live electrical apparatus will cause severe injury or death.
- In accordance with the *Electricity Supply Act 1995*, you are obliged to report any damage to Endeavour Energy Assets immediately by calling **131 003**.
- The customer must obtain a new set of plans from Endeavour Energy if work has not been started or completed within twenty (20) working days of the original plan issue date.
- The customer must contact Endeavour Energy if any of the plans provided have blank pages, as some underground asset information may be incomplete.
- Endeavour Energy underground earth grids may exist and their location **may not** be shown on plans. Persons excavating are expected to exercise all due care, especially in the vicinity of padmount substations, pole mounted substations, pole mounted switches, transmission poles and towers.
- Endeavour Energy plans **do not** show any underground customer service mains or information relating to service mains within private property.
- Asbestos or asbestos-containing material may be present on or near Endeavour Energy's underground assets.
- Organo-Chloride Pesticides (OCP) may be present in some sub-transmission trenches.
- All plans must be printed and made available at the worksite where excavation is to be undertaken. Plans must be reviewed and understood by the crew on site prior to commencing excavation.











INFORMATION PROVIDED BY ENDEAVOUR ENERGY

- Any plans provided pursuant to this service are intended to show the approximate location of underground assets relative to road boundaries, property fences and other structures at the time of installation.
- Depth of underground assets may vary significantly from information provided on plans as a result of changes to road, footpath or surface levels subsequent to installation.
- Such plans have been prepared solely for use by Endeavour Energy staff for design, construction and maintenance purposes.
- All enquiry details and results are kept in a register.

DISCLAIMER

Whilst Endeavour Energy has taken all reasonable steps to ensure that the information contained in the plans is as accurate as possible it will accept no liability for inaccuracies in the information shown on such plans.

LEGEND

-  OR  Street light column
-  Padmount substation
-  OR  Overground pillar (O.G.Box)
-  Underground pit
-  Duct run
-  Cable run
-  Typical duct section
-  Asbestos warning



NOT TO SCALE

DBYD Sequence No.:	105300013
Issued Date:	07/01/2021

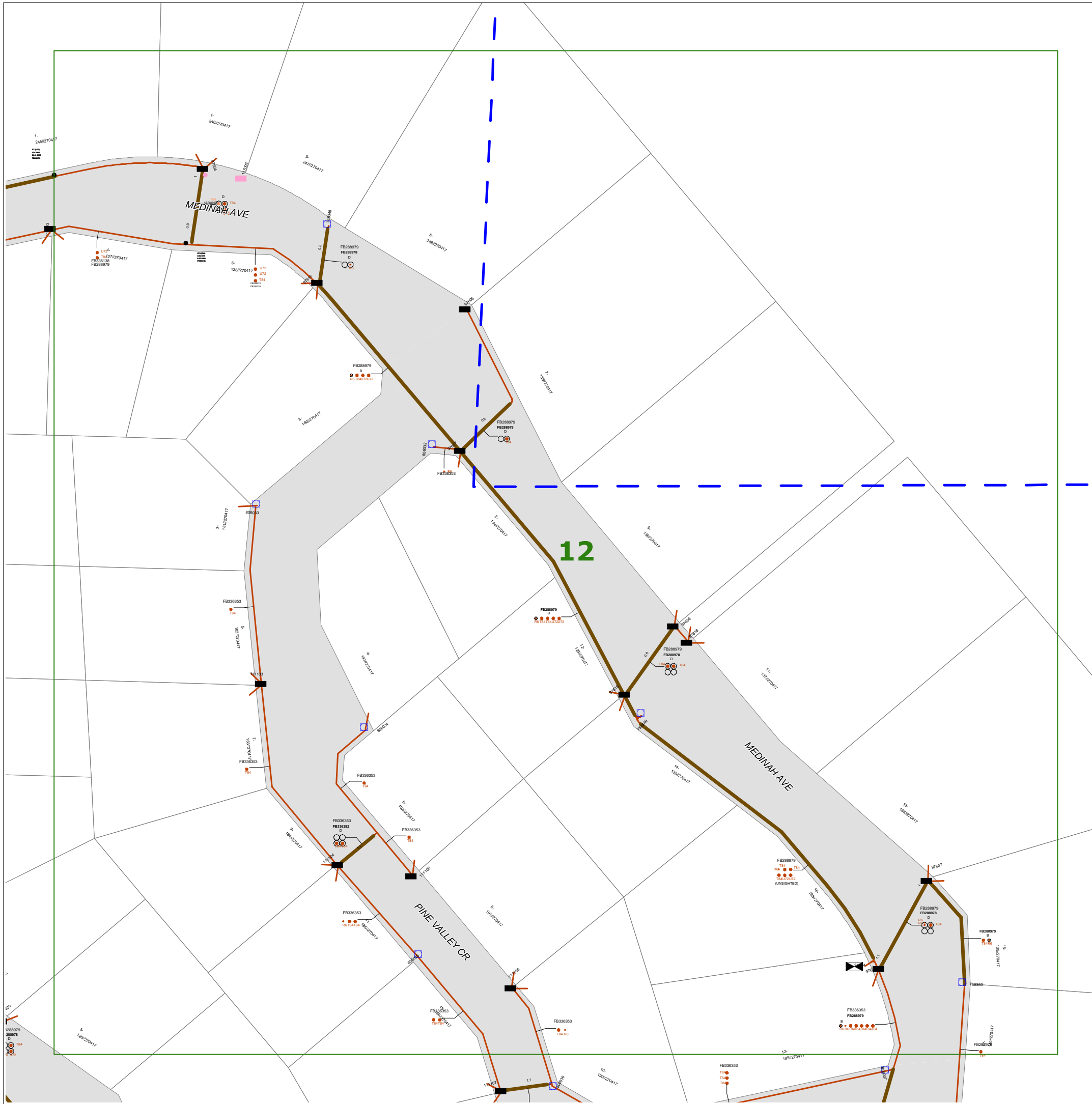

WARNING

- **All electrical apparatus shall be regarded as live until proved de-energised.** Contact with live electrical apparatus will cause severe injury or death.
- In accordance with the *Electricity Supply Act 1995*, you are obliged to report any damage to Endeavour Energy Assets immediately by calling **131 003**.
- The customer must obtain a new set of plans from Endeavour Energy if work has not been started or completed within twenty (20) working days of the original plan issue date.
- The customer must contact Endeavour Energy if any of the plans provided have blank pages, as some underground asset information may be incomplete.
- Endeavour Energy underground earth grids may exist and their location **may not** be shown on plans. Persons excavating are expected to exercise all due care, especially in the vicinity of padmount substations, pole mounted substations, pole mounted switches, transmission poles and towers.
- Endeavour Energy plans **do not** show any underground customer service mains or information relating to service mains within private property.
- Asbestos or asbestos-containing material may be present on or near Endeavour Energy's underground assets.
- Organo-Chloride Pesticides (OCP) may be present in some sub-transmission trenches.
- All plans must be printed and made available at the worksite where excavation is to be undertaken. Plans must be reviewed and understood by the crew on site prior to commencing excavation.

INFORMATION PROVIDED BY ENDEAVOUR ENERGY

- Any plans provided pursuant to this service are intended to show the approximate location of underground assets relative to road boundaries, property fences and other structures at the time of installation.
- Depth of underground assets may vary significantly from information provided on plans as a result of changes to road, footpath or surface levels subsequent to installation.
- Such plans have been prepared solely for use by Endeavour Energy staff for design, construction and maintenance purposes.
- All enquiry details and results are kept in a register.

DISCLAIMER

Whilst Endeavour Energy has taken all reasonable steps to ensure that the information contained in the plans is as accurate as possible it will accept no liability for inaccuracies in the information shown on such plans.

LEGEND

- or ■ Street light column
- ▭ Padmount substation
- or ■ Overground pillar (O.G.Box)
- ▭ Underground pit
- Duct run
- Cable run
- ⊙ Typical duct section
- ▲ Asbestos warning



NOT TO SCALE

DBYD Sequence No.:	105300013
Issued Date:	07/01/2021

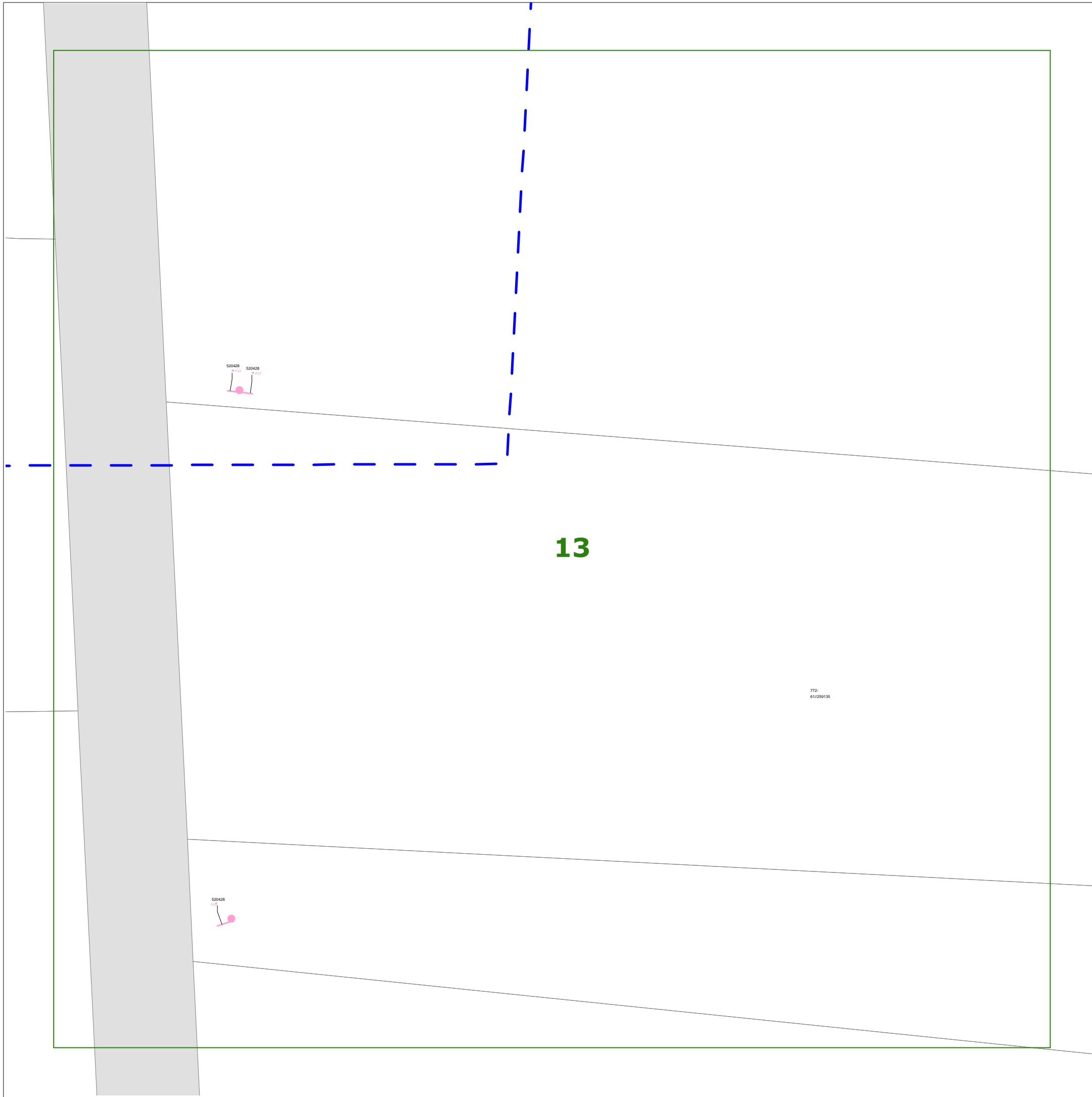

A2 Jemena

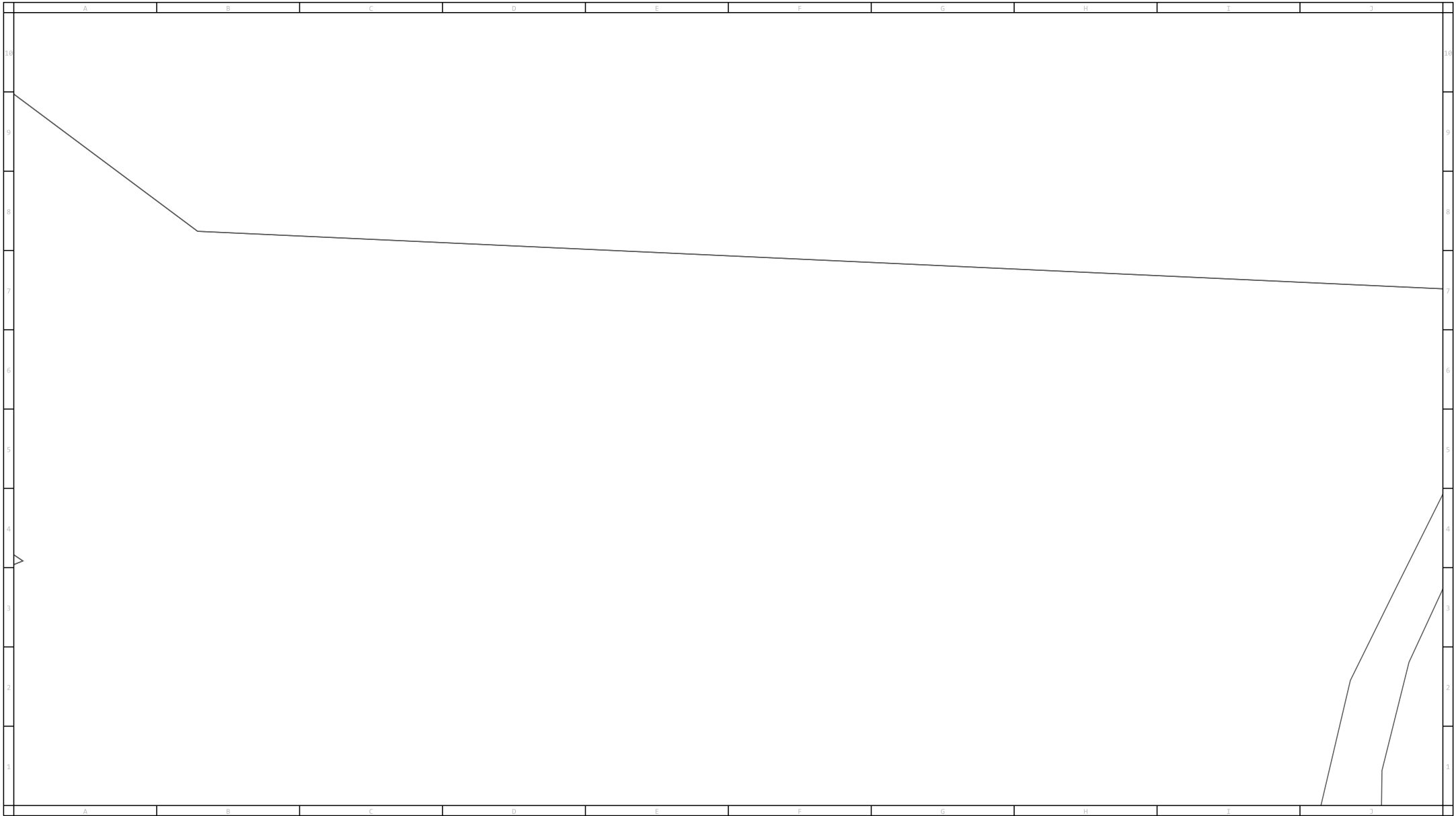

For legend details, please refer to the Coversheet attachment provided as part of this DBYD response.

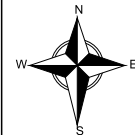

Scale: 1:2000

Issue Date: 07/01/2021

DBYD Seq No: 105303000

DBYD Job No: 20857093

0m 10m 20m 30m 40m 50m 60m 70m 80m



WARNING: This is a representation of Jemena Gas Networks underground assets only and may not indicate all assets in the area. It must not be used for the purpose of exact asset location in order to undertake any type of excavation. This plan is diagrammatic only, and distances scaled from this plan may not be accurate. Please read all conditions and information on the attached information sheet. This extract is subject to those conditions. The information contained on this plan is only valid for 28 days from the date of issue.

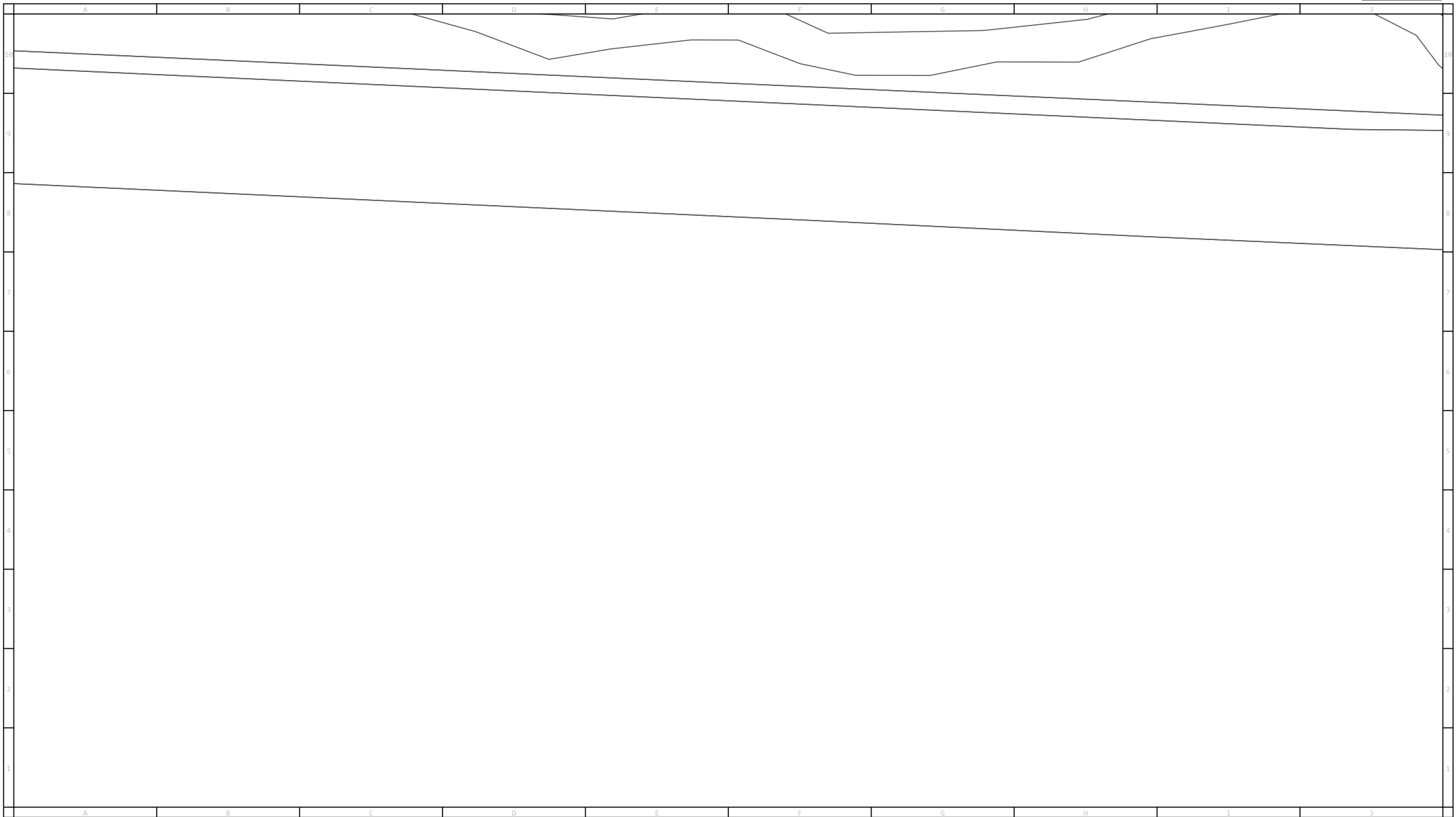

For legend details, please refer to the Coversheet attachment provided as part of this DBYD response.

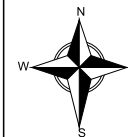

Scale: 1:2000

Issue Date: 07/01/2021

DBYD Seq No: 105303000

DBYD Job No: 20857093

0m 10m 20m 30m 40m 50m 60m 70m 80m



WARNING: This is a representation of Jemena Gas Networks underground assets only and may not indicate all assets in the area. It must not be used for the purpose of exact asset location in order to undertake any type of excavation. This plan is diagrammatic only, and distances scaled from this plan may not be accurate. Please read all conditions and information on the attached information sheet. This extract is subject to those conditions. The information contained on this plan is only valid for 28 days from the date of issue.

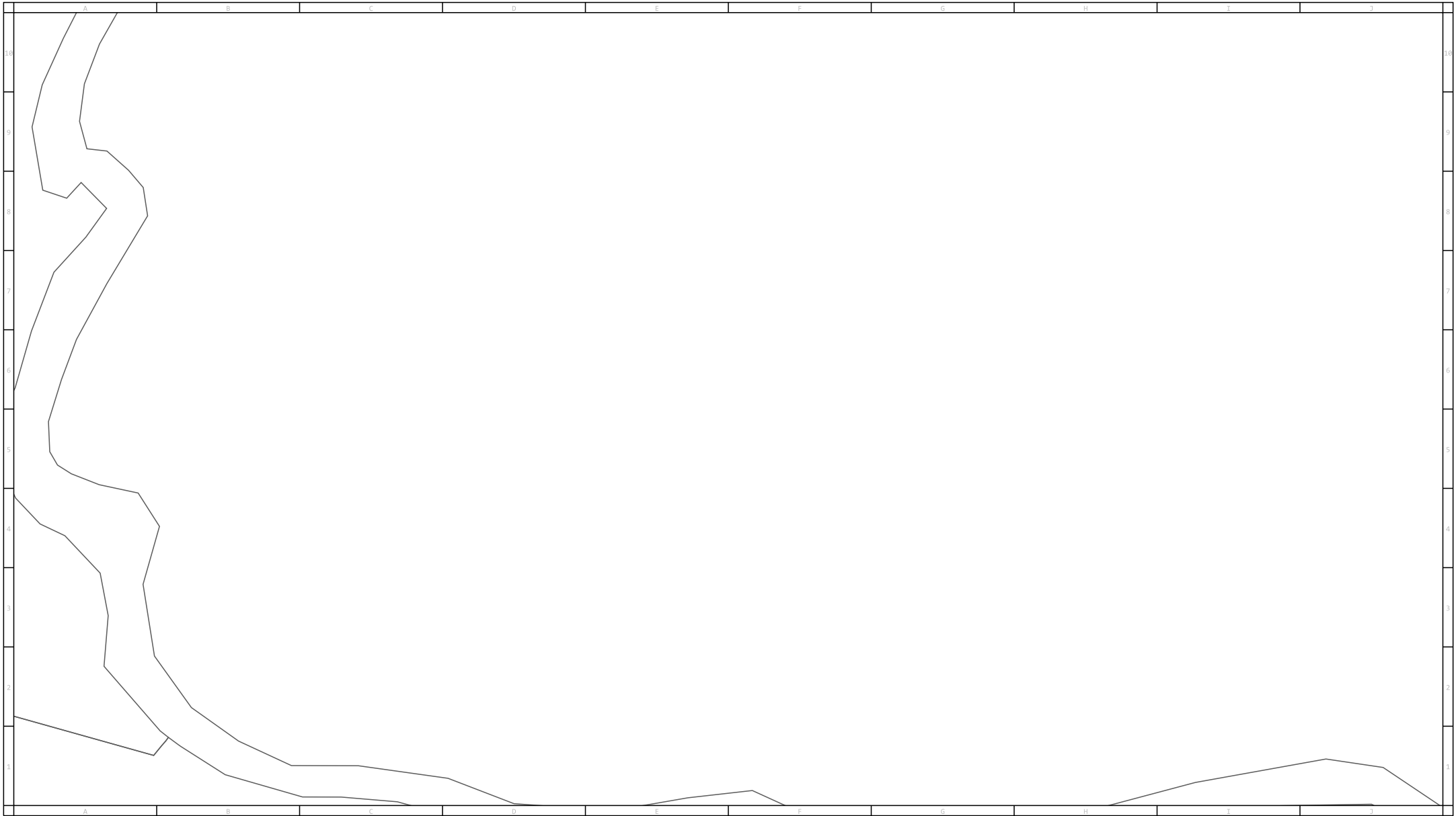

For legend details, please refer to the Coversheet attachment provided as part of this DBYD response.

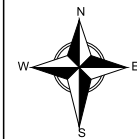

Scale: 1:2000

Issue Date: 07/01/2021

DBYD Seq No: 105303000

DBYD Job No: 20857093

0m 10m 20m 30m 40m 50m 60m 70m 80m



WARNING: This is a representation of Jemena Gas Networks underground assets only and may not indicate all assets in the area. It must not be used for the purpose of exact asset location in order to undertake any type of excavation. This plan is diagrammatic only, and distances scaled from this plan may not be accurate. Please read all conditions and information on the attached information sheet. This extract is subject to those conditions. The information contained on this plan is only valid for 28 days from the date of issue.

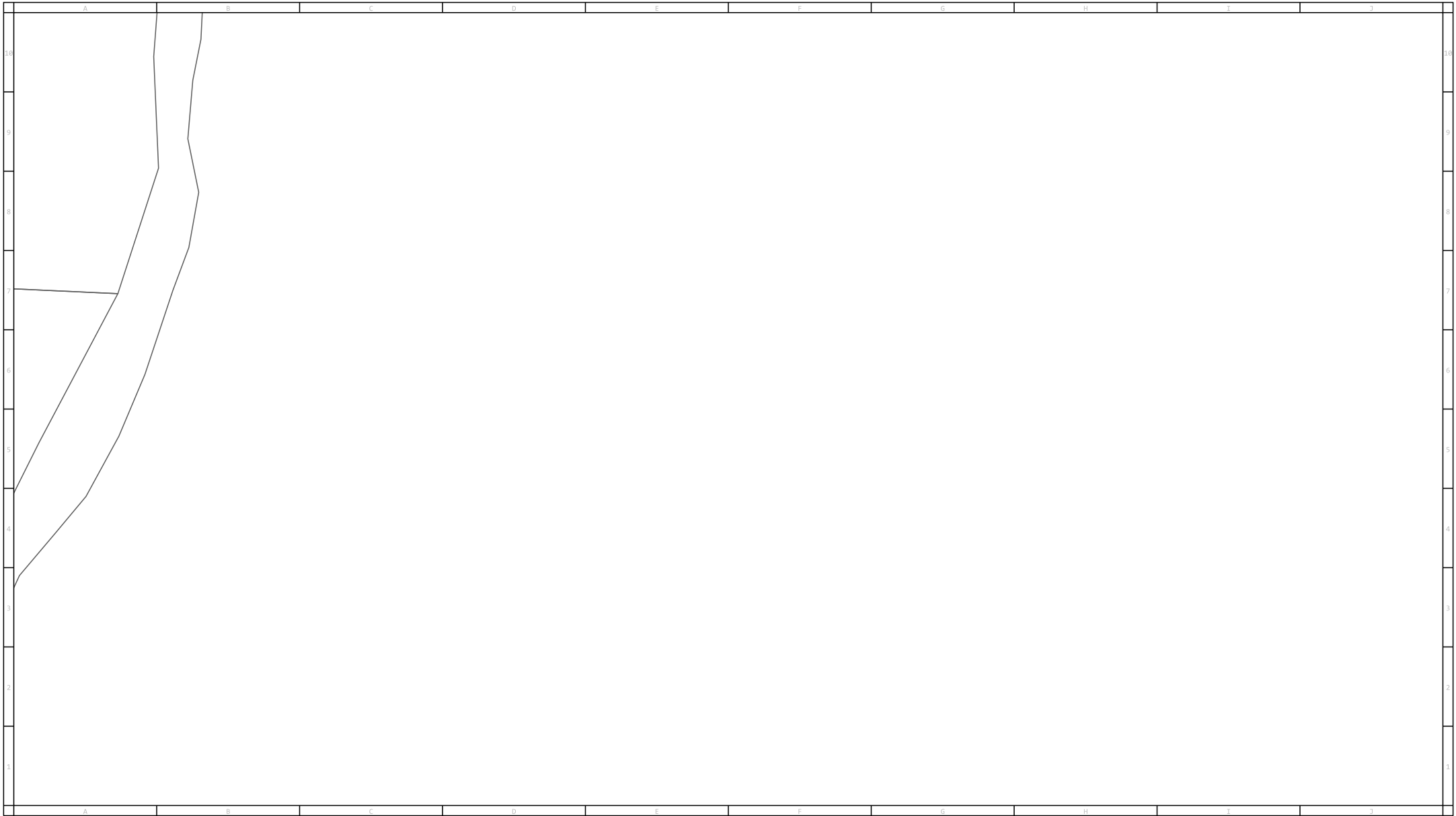

For legend details, please refer to the Coversheet attachment provided as part of this DBYD response.

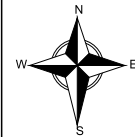

Scale: 1:2000

Issue Date: 07/01/2021

DBYD Seq No: 105303000

DBYD Job No: 20857093

0m 10m 20m 30m 40m 50m 60m 70m 80m



WARNING: This is a representation of Jemena Gas Networks underground assets only and may not indicate all assets in the area. It must not be used for the purpose of exact asset location in order to undertake any type of excavation. This plan is diagrammatic only, and distances scaled from this plan may not be accurate. Please read all conditions and information on the attached information sheet. This extract is subject to those conditions. The information contained on this plan is only valid for 28 days from the date of issue.

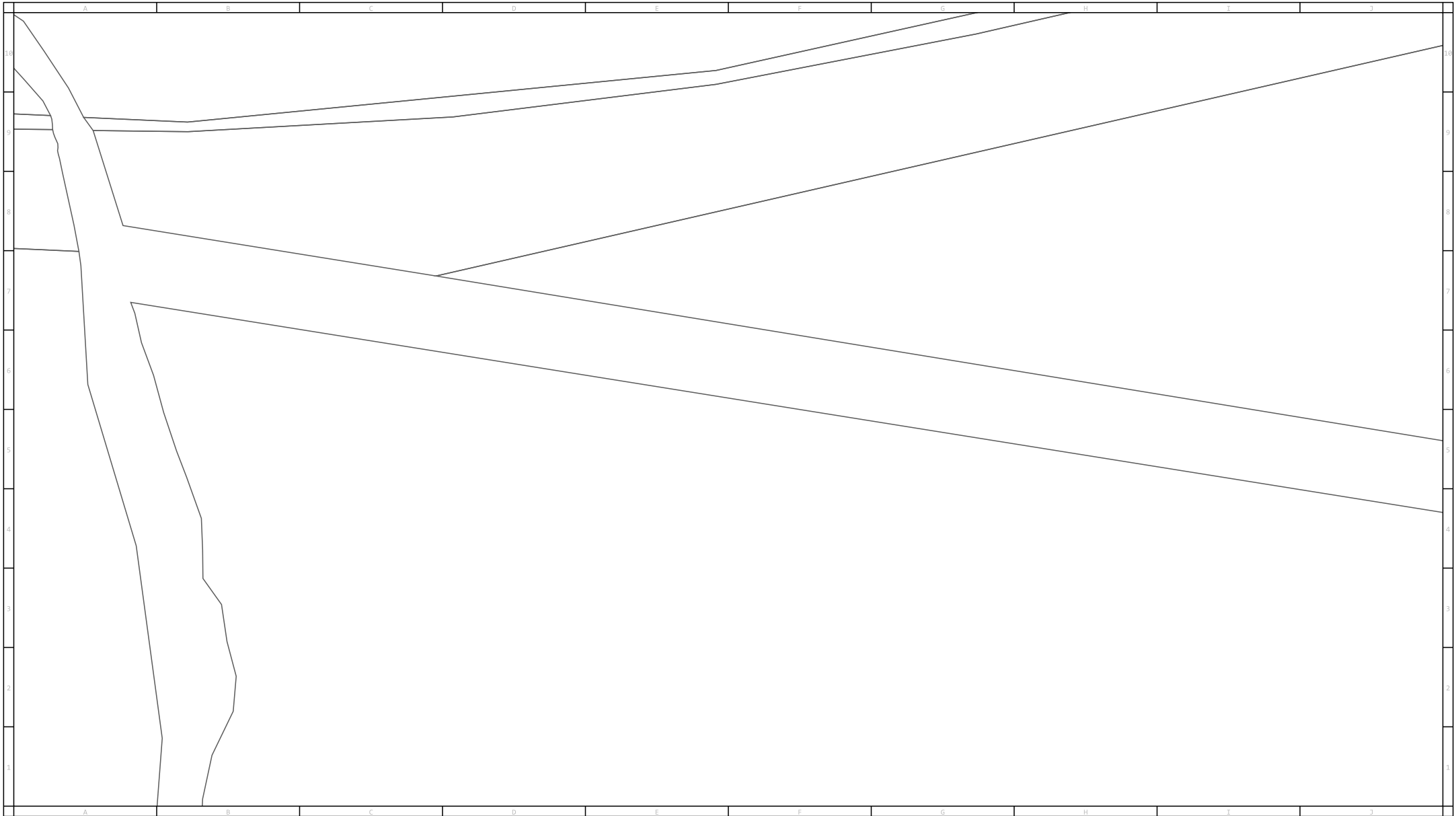

For legend details, please refer to the Coversheet attachment provided as part of this DBYD response.

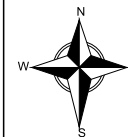

Scale: 1:2000

Issue Date: 07/01/2021

DBYD Seq No: 105303000

DBYD Job No: 20857093

0m 10m 20m 30m 40m 50m 60m 70m 80m



WARNING: This is a representation of Jemena Gas Networks underground assets only and may not indicate all assets in the area. It must not be used for the purpose of exact asset location in order to undertake any type of excavation. This plan is diagrammatic only, and distances scaled from this plan may not be accurate. Please read all conditions and information on the attached information sheet. This extract is subject to those conditions. The information contained on this plan is only valid for 28 days from the date of issue.

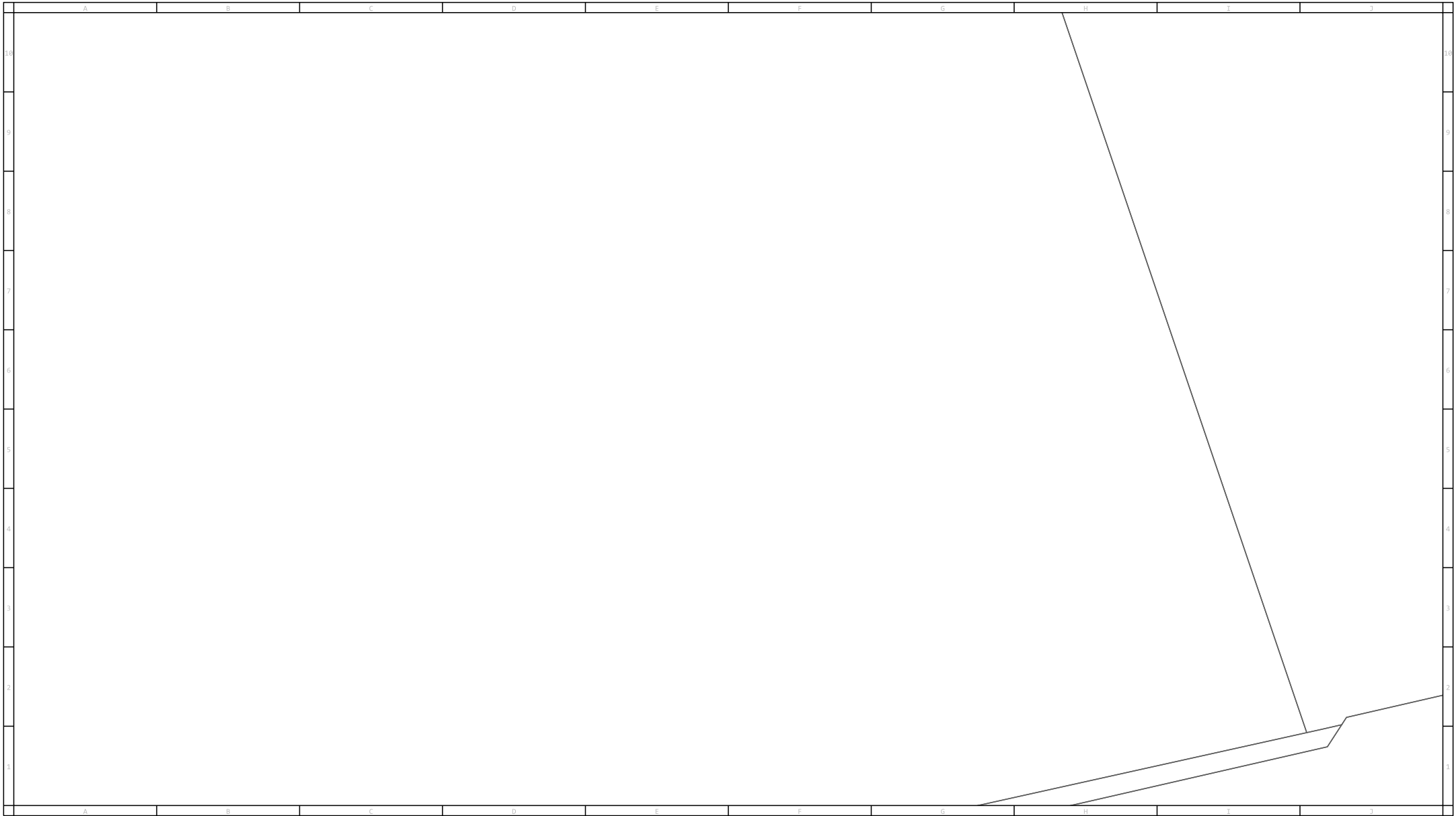

For legend details, please refer to the Coversheet attachment provided as part of this DBYD response.

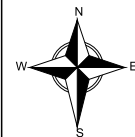

Scale: 1:2000

Issue Date: 07/01/2021

DBYD Seq No: 105303000

DBYD Job No: 20857093

0m 10m 20m 30m 40m 50m 60m 70m 80m



WARNING: This is a representation of Jemena Gas Networks underground assets only and may not indicate all assets in the area. It must not be used for the purpose of exact asset location in order to undertake any type of excavation. This plan is diagrammatic only, and distances scaled from this plan may not be accurate. Please read all conditions and information on the attached information sheet. This extract is subject to those conditions. The information contained on this plan is only valid for 28 days from the date of issue.

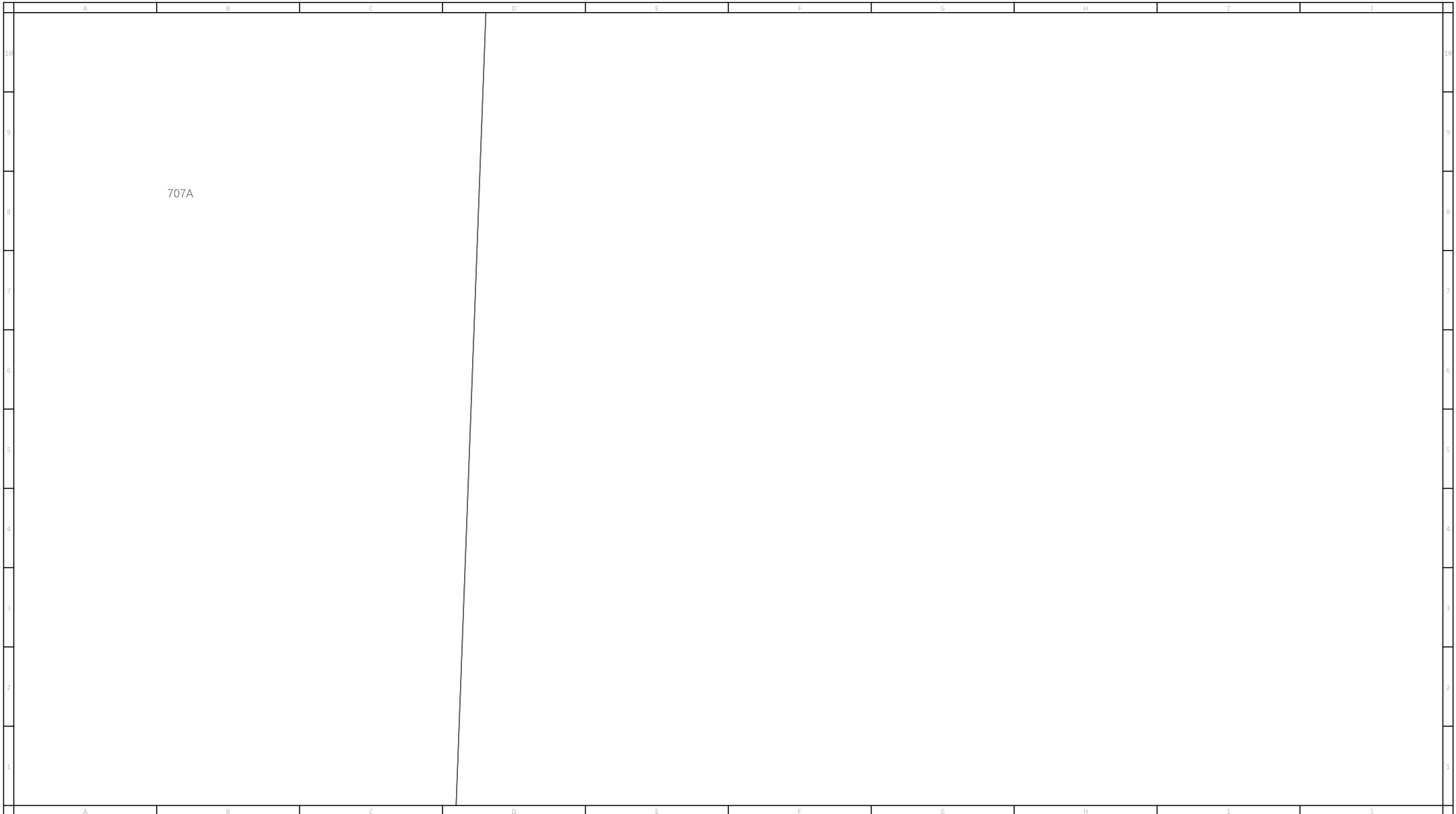

For legend details, please refer to the Coversheet attachment provided as part of this DBYD response.

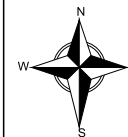

Scale: 1:2000

Issue Date: 07/01/2021

DBYD Seq No: 105303000

DBYD Job No: 20857093

0m 10m 20m 30m 40m 50m 60m 70m 80m



WARNING: This is a representation of Jemena Gas Networks underground assets only and may not indicate all assets in the area. It must not be used for the purpose of exact asset location in order to undertake any type of excavation. This plan is diagrammatic only, and distances scaled from this plan may not be accurate. Please read all conditions and information on the attached information sheet. This extract is subject to those conditions. The information contained on this plan is only valid for 28 days from the date of issue.

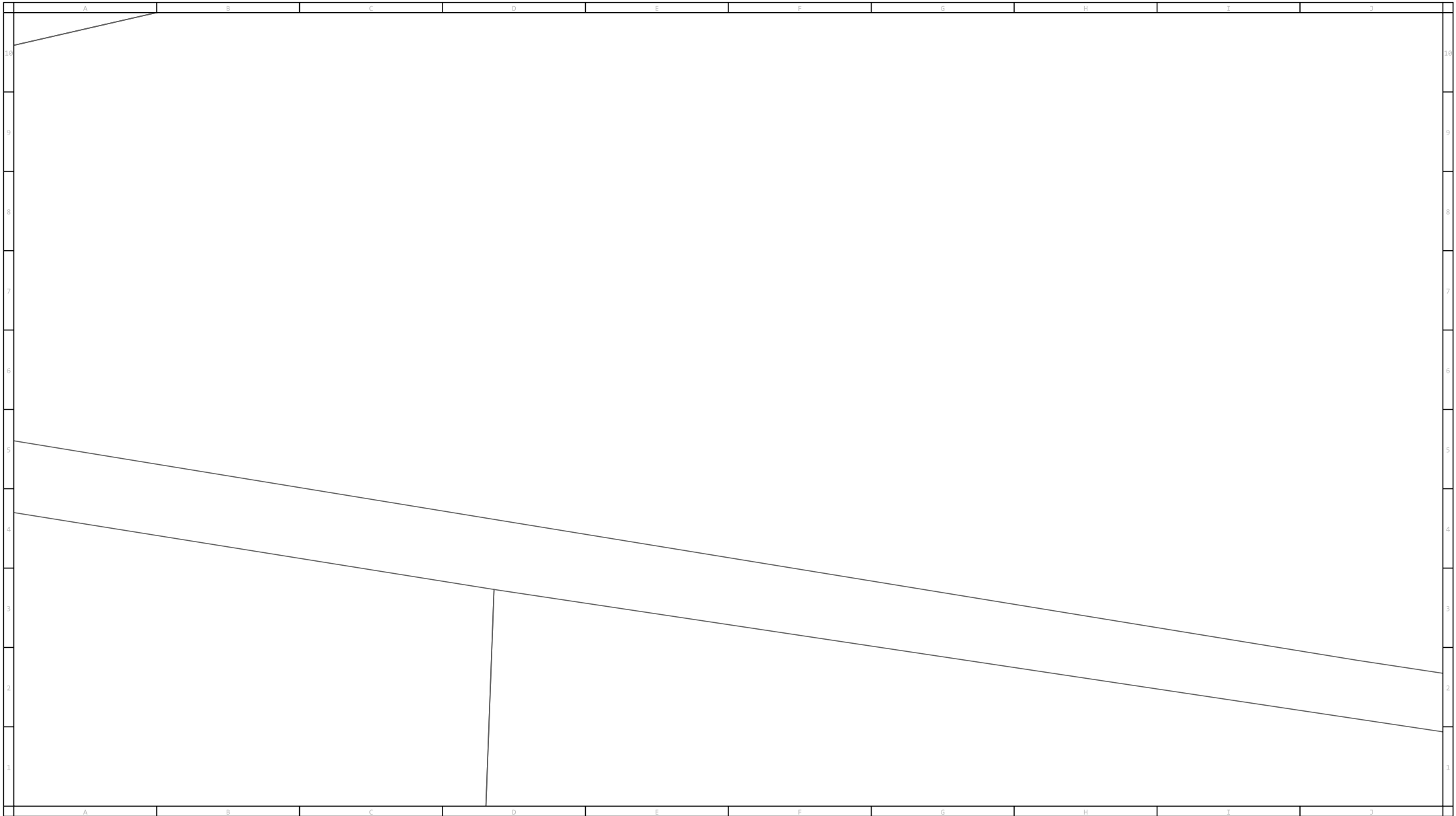

For legend details, please refer to the Coversheet attachment provided as part of this DBYD response.

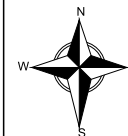

Scale: 1:2000

Issue Date: 07/01/2021

DBYD Seq No: 105303000

DBYD Job No: 20857093

0m 10m 20m 30m 40m 50m 60m 70m 80m



WARNING: This is a representation of Jemena Gas Networks underground assets only and may not indicate all assets in the area. It must not be used for the purpose of exact asset location in order to undertake any type of excavation. This plan is diagrammatic only, and distances scaled from this plan may not be accurate. Please read all conditions and information on the attached information sheet. This extract is subject to those conditions. The information contained on this plan is only valid for 28 days from the date of issue.

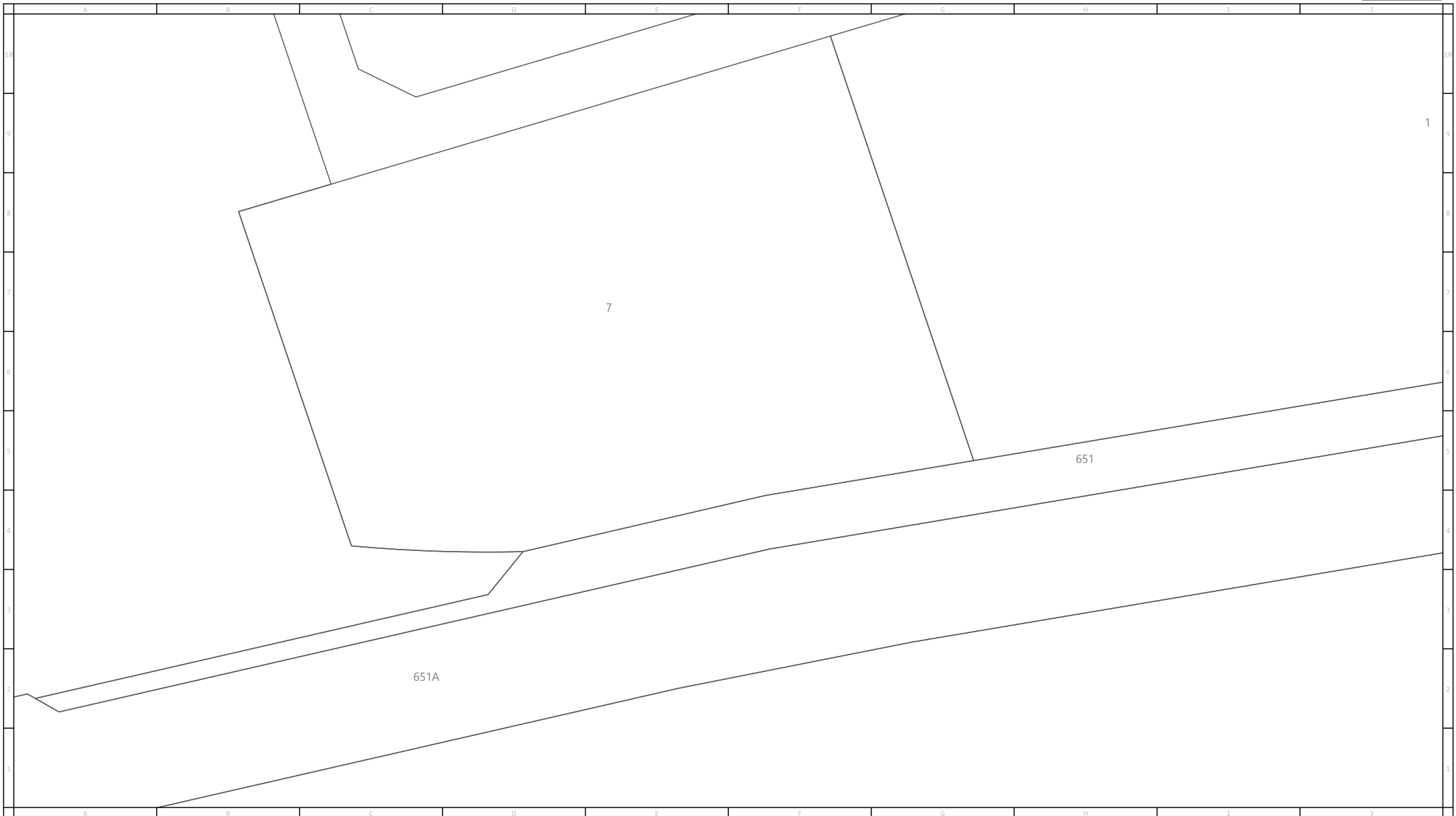

For legend details, please refer to the Coversheet attachment provided as part of this DBYD response.

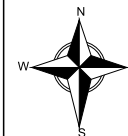

Scale: 1:2000

Issue Date: 07/01/2021

DBYD Seq No: 105303000

DBYD Job No: 20857093

0m 10m 20m 30m 40m 50m 60m 70m 80m



WARNING: This is a representation of Jemena Gas Networks underground assets only and may not indicate all assets in the area. It must not be used for the purpose of exact asset location in order to undertake any type of excavation. This plan is diagrammatic only, and distances scaled from this plan may not be accurate. Please read all conditions and information on the attached information sheet. This extract is subject to those conditions. The information contained on this plan is only valid for 28 days from the date of issue.

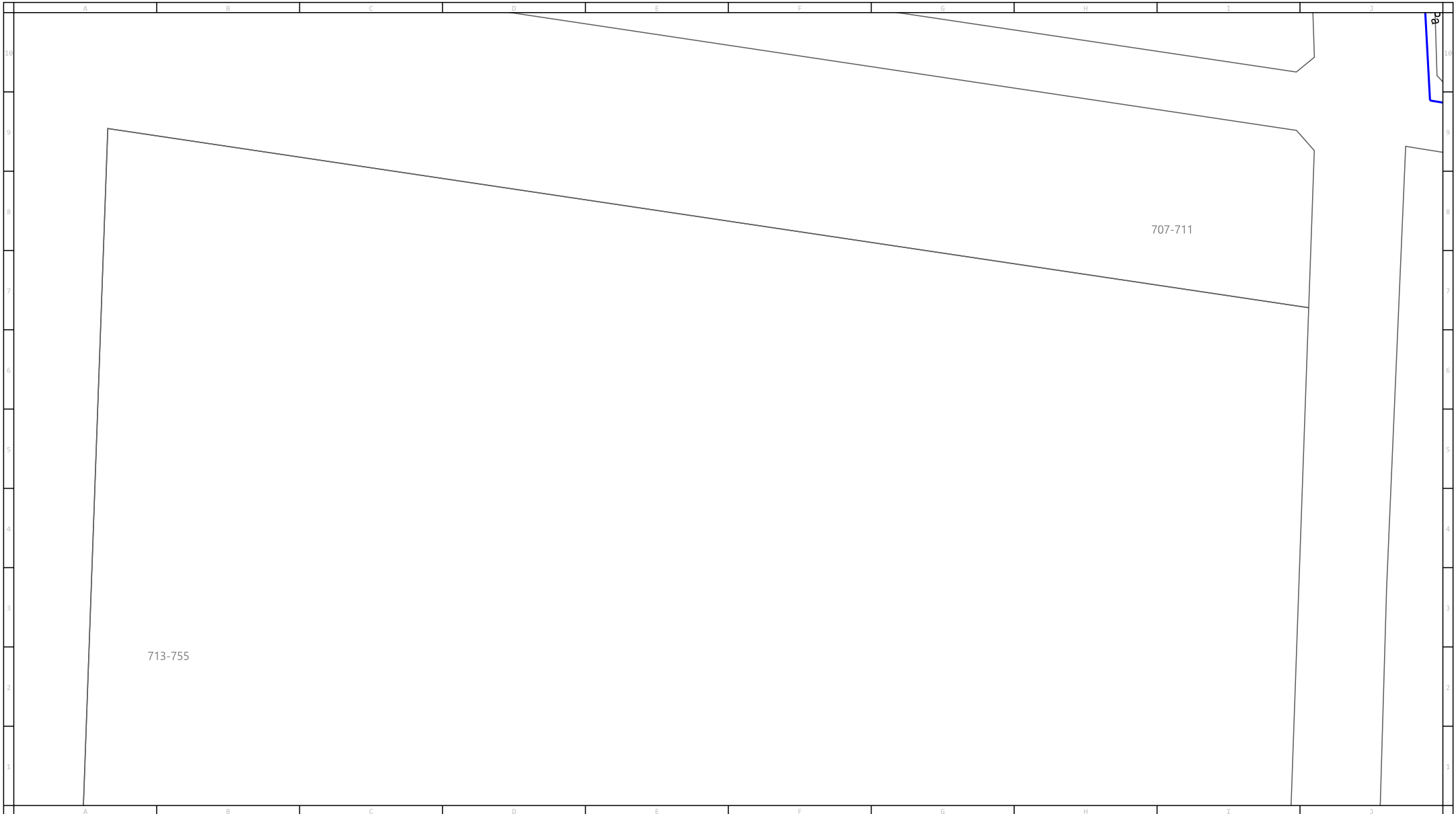

For legend details, please refer to the Coversheet attachment provided as part of this DBYD response.

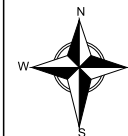

Scale: 1:2000

Issue Date: 07/01/2021

DBYD Seq No: 105303000

DBYD Job No: 20857093

0m 10m 20m 30m 40m 50m 60m 70m 80m



WARNING: This is a representation of Jemena Gas Networks underground assets only and may not indicate all assets in the area. It must not be used for the purpose of exact asset location in order to undertake any type of excavation. This plan is diagrammatic only, and distances scaled from this plan may not be accurate. Please read all conditions and information on the attached information sheet. This extract is subject to those conditions. The information contained on this plan is only valid for 28 days from the date of issue.

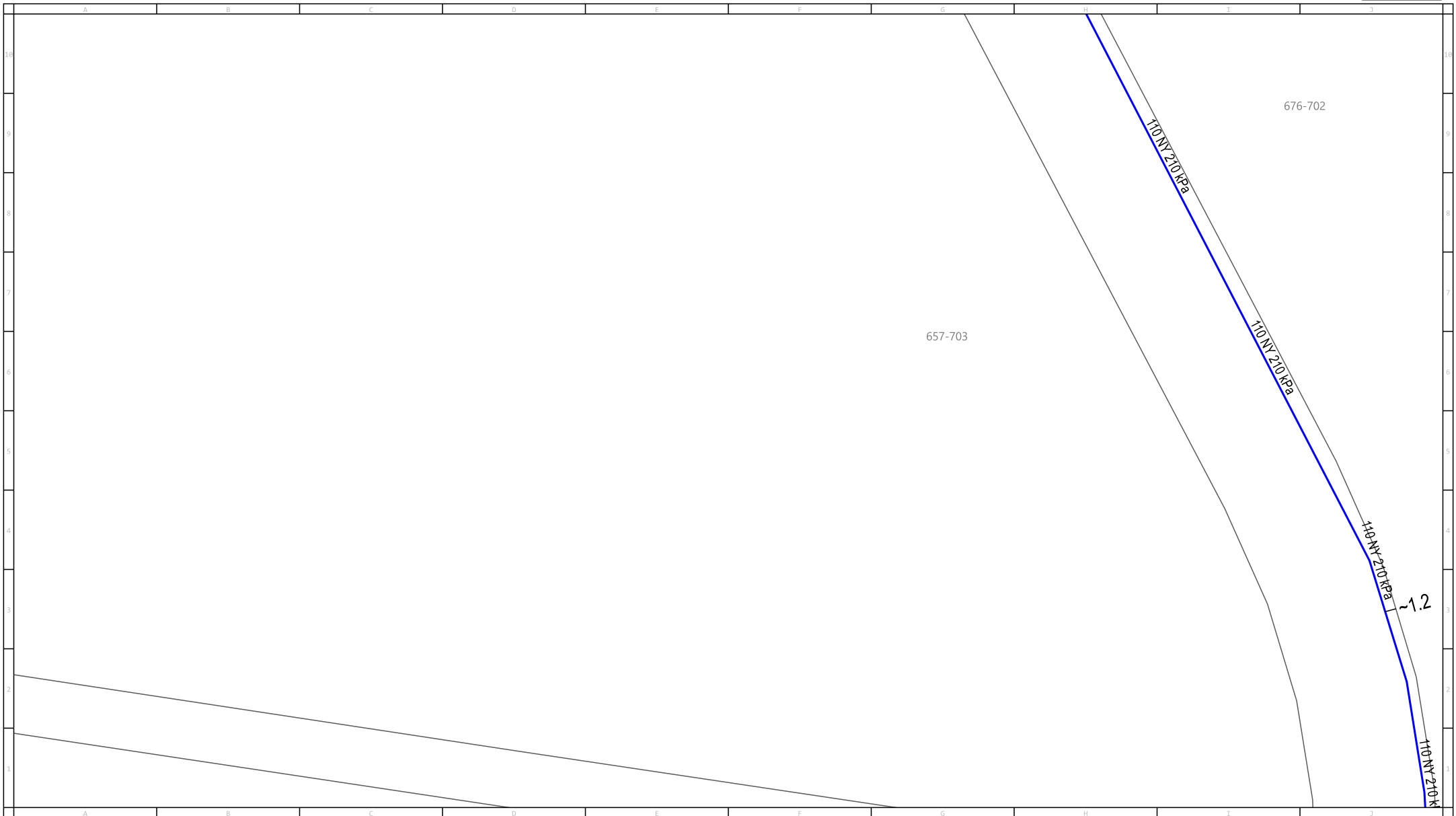

For legend details, please refer to the Coversheet attachment provided as part of this DBYD response.

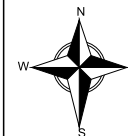

Scale: 1:2000

Issue Date: 07/01/2021

DBYD Seq No: 105303000

DBYD Job No: 20857093

0m 10m 20m 30m 40m 50m 60m 70m 80m



WARNING: This is a representation of Jemena Gas Networks underground assets only and may not indicate all assets in the area. It must not be used for the purpose of exact asset location in order to undertake any type of excavation. This plan is diagrammatic only, and distances scaled from this plan may not be accurate. Please read all conditions and information on the attached information sheet. This extract is subject to those conditions. The information contained on this plan is only valid for 28 days from the date of issue.

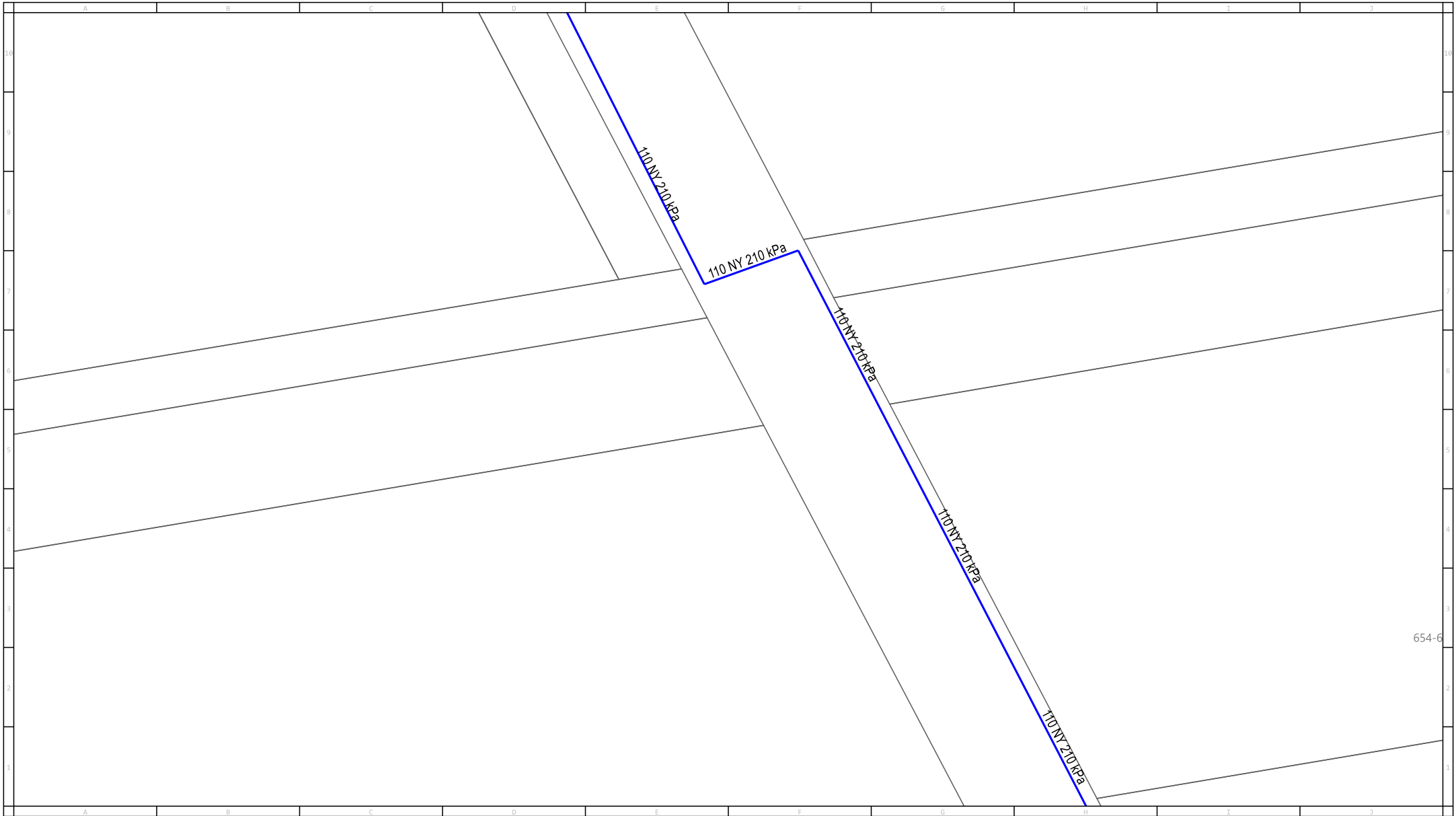

For legend details, please refer to the Coversheet attachment provided as part of this DBYD response.

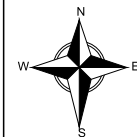

Scale: 1:2000

Issue Date: 07/01/2021

DBYD Seq No: 105303000

DBYD Job No: 20857093

0m 10m 20m 30m 40m 50m 60m 70m 80m



WARNING: This is a representation of Jemena Gas Networks underground assets only and may not indicate all assets in the area. It must not be used for the purpose of exact asset location in order to undertake any type of excavation. This plan is diagrammatic only, and distances scaled from this plan may not be accurate. Please read all conditions and information on the attached information sheet. This extract is subject to those conditions. The information contained on this plan is only valid for 28 days from the date of issue.

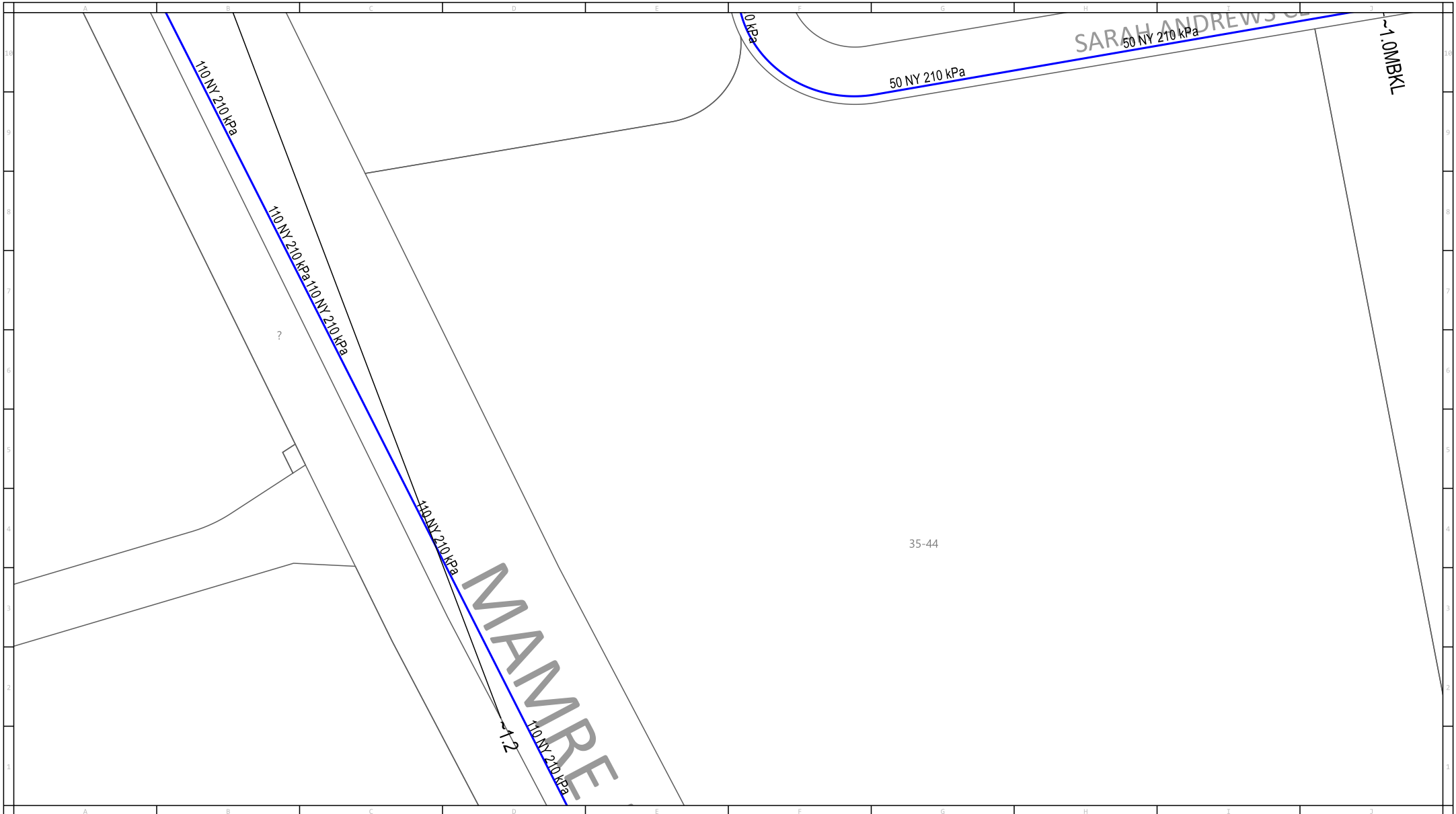

For legend details, please refer to the Coversheet attachment provided as part of this DBYD response.

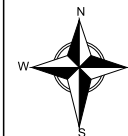

Scale: 1:2000

Issue Date: 07/01/2021

DBYD Seq No: 105303000

DBYD Job No: 20857093

0m 10m 20m 30m 40m 50m 60m 70m 80m



WARNING: This is a representation of Jemena Gas Networks underground assets only and may not indicate all assets in the area. It must not be used for the purpose of exact asset location in order to undertake any type of excavation. This plan is diagrammatic only, and distances scaled from this plan may not be accurate. Please read all conditions and information on the attached information sheet. This extract is subject to those conditions. The information contained on this plan is only valid for 28 days from the date of issue.

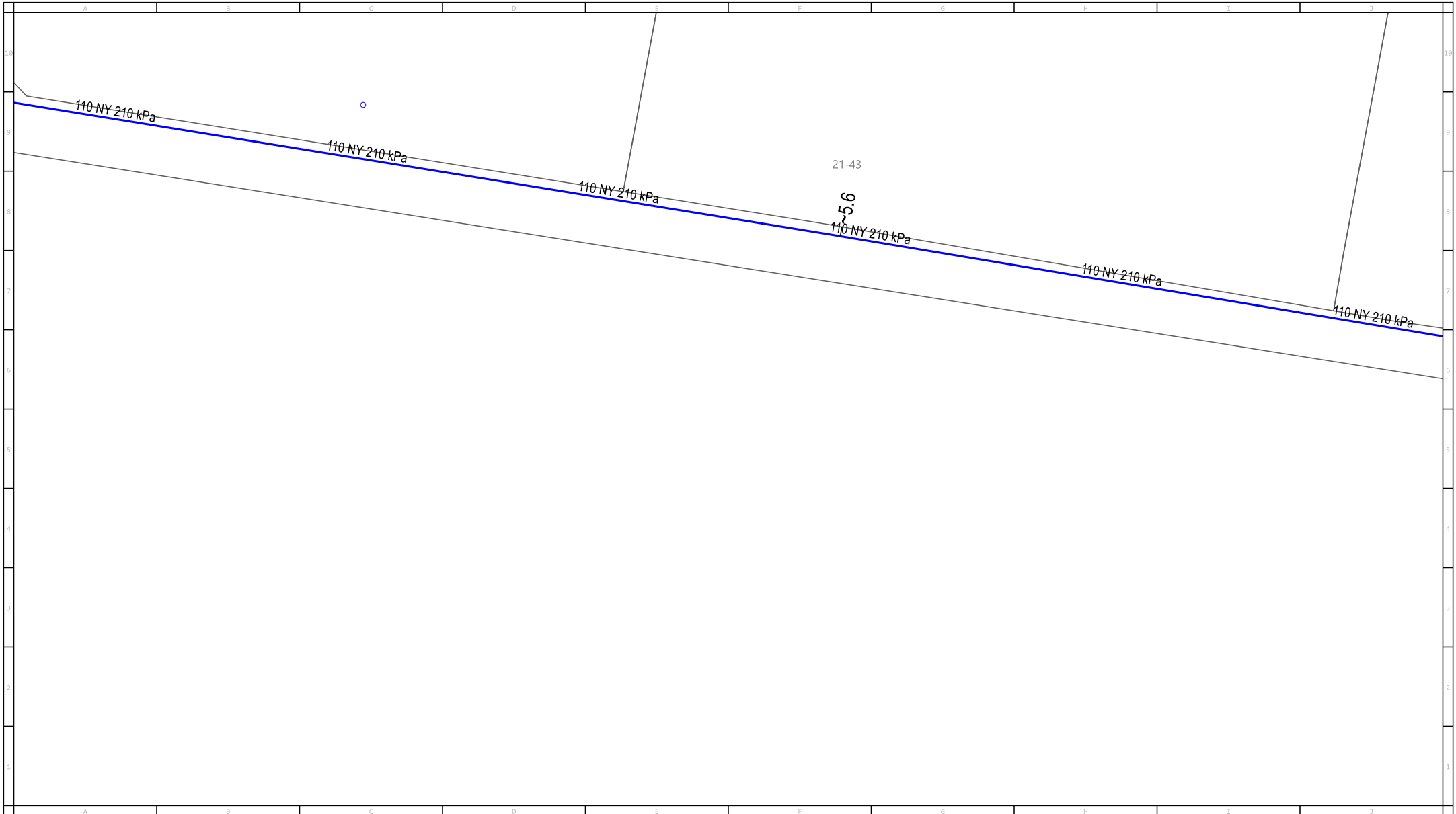

For legend details, please refer to the Coversheet attachment provided as part of this DBYD response.

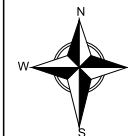

Scale: 1:2000

Issue Date: 07/01/2021

DBYD Seq No: 105303000

DBYD Job No: 20857093

0m 10m 20m 30m 40m 50m 60m 70m 80m



WARNING: This is a representation of Jemena Gas Networks underground assets only and may not indicate all assets in the area. It must not be used for the purpose of exact asset location in order to undertake any type of excavation. This plan is diagrammatic only, and distances scaled from this plan may not be accurate. Please read all conditions and information on the attached information sheet. This extract is subject to those conditions. The information contained on this plan is only valid for 28 days from the date of issue.

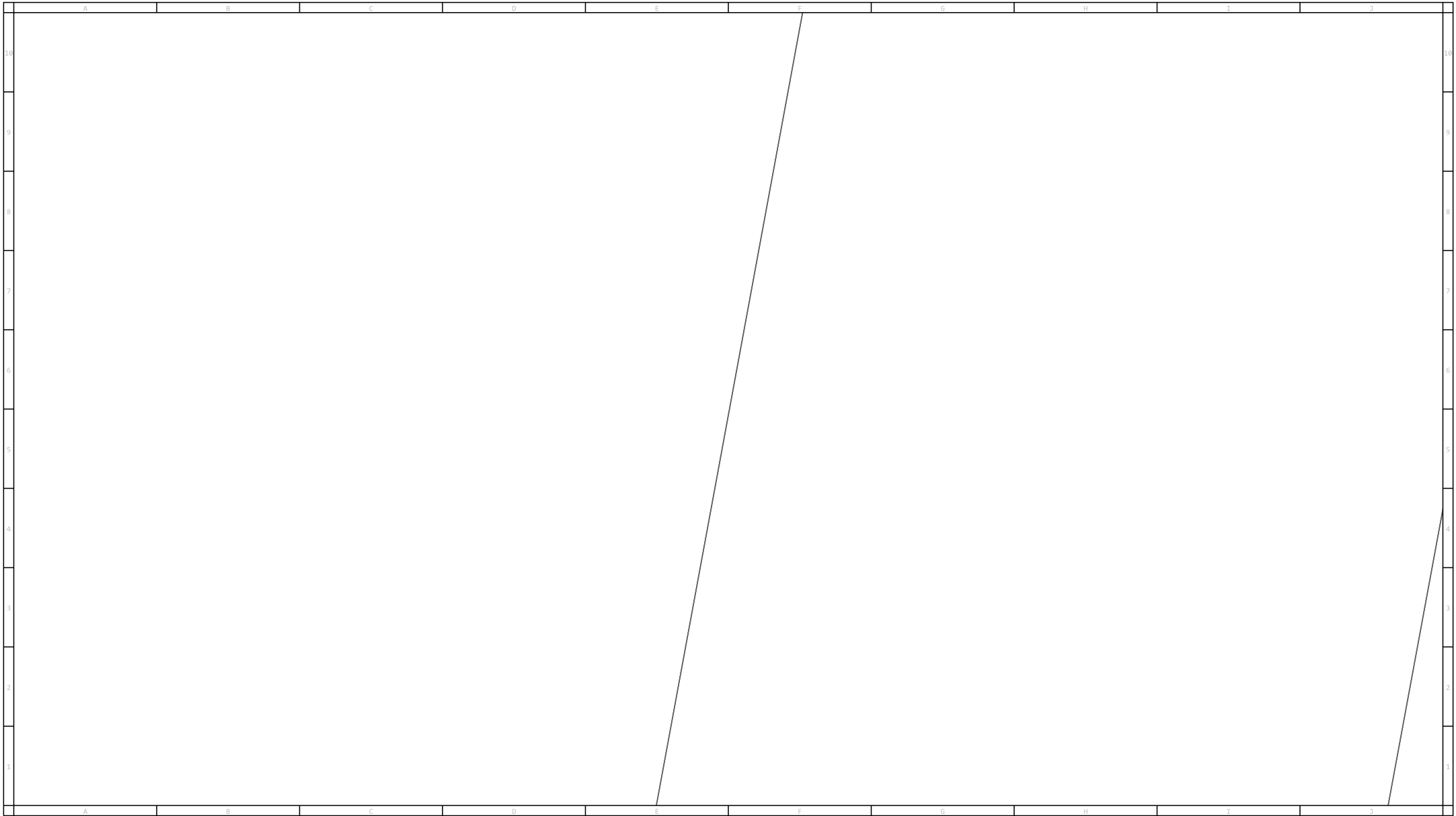

For legend details, please refer to the Coversheet attachment provided as part of this DBYD response.

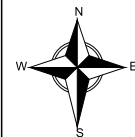

Scale: 1:2000

Issue Date: 07/01/2021

DBYD Seq No: 105303000

DBYD Job No: 20857093

0m 10m 20m 30m 40m 50m 60m 70m 80m



WARNING: This is a representation of Jemena Gas Networks underground assets only and may not indicate all assets in the area. It must not be used for the purpose of exact asset location in order to undertake any type of excavation. This plan is diagrammatic only, and distances scaled from this plan may not be accurate. Please read all conditions and information on the attached information sheet. This extract is subject to those conditions. The information contained on this plan is only valid for 28 days from the date of issue.

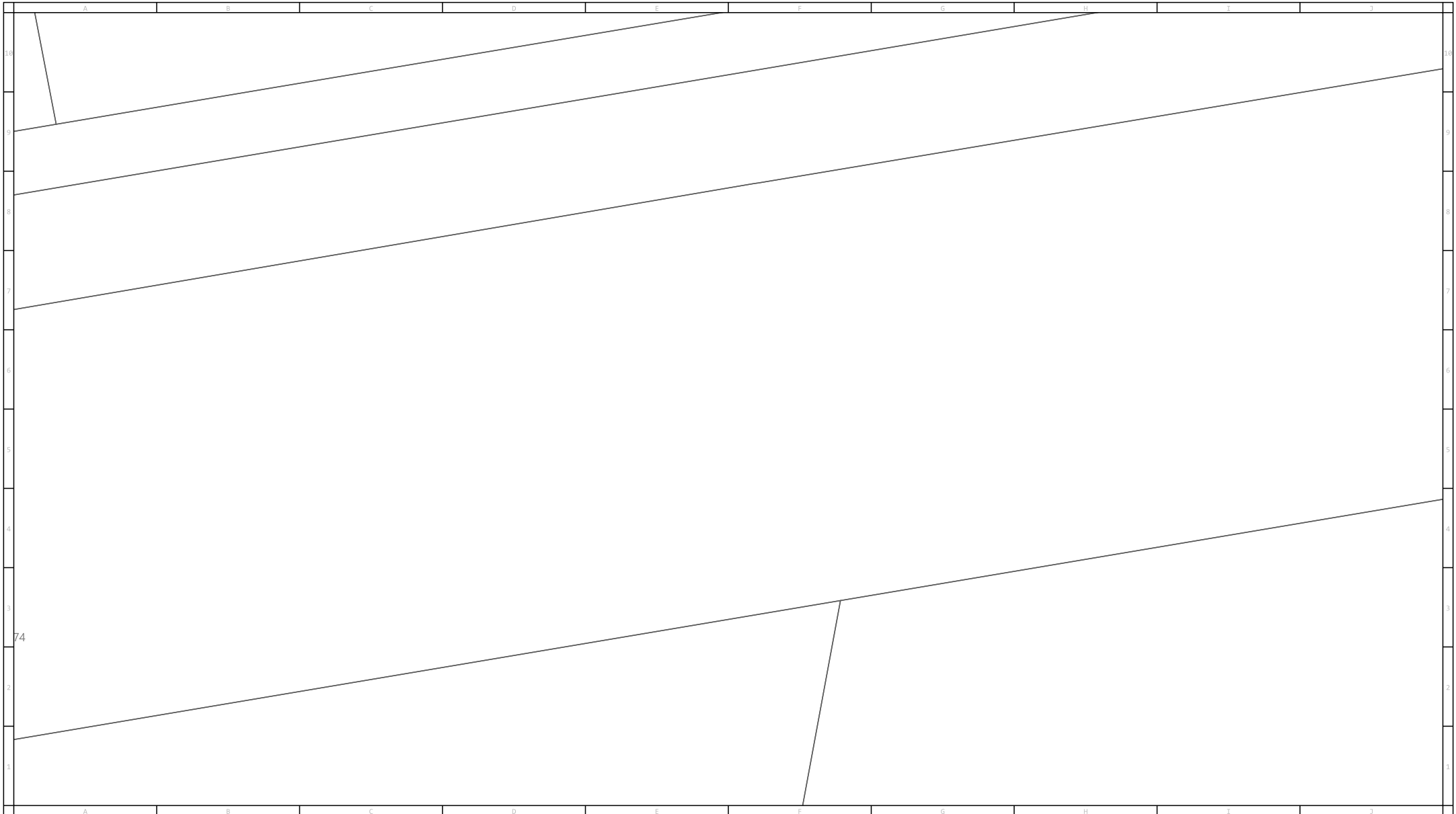

For legend details, please refer to the Coversheet attachment provided as part of this DBYD response.

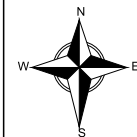

Scale: 1:2000

Issue Date: 07/01/2021

DBYD Seq No: 105303000

DBYD Job No: 20857093

0m 10m 20m 30m 40m 50m 60m 70m 80m



WARNING: This is a representation of Jemena Gas Networks underground assets only and may not indicate all assets in the area. It must not be used for the purpose of exact asset location in order to undertake any type of excavation. This plan is diagrammatic only, and distances scaled from this plan may not be accurate. Please read all conditions and information on the attached information sheet. This extract is subject to those conditions. The information contained on this plan is only valid for 28 days from the date of issue.



For legend details, please refer to the Coversheet attachment provided as part of this DBYD response.

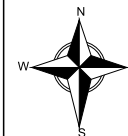

Scale: 1:2000

Issue Date: 07/01/2021

DBYD Seq No: 105303053

DBYD Job No: 20857103

0m 10m 20m 30m 40m 50m 60m 70m 80m



WARNING: This is a representation of Jemena Gas Networks underground assets only and may not indicate all assets in the area. It must not be used for the purpose of exact asset location in order to undertake any type of excavation. This plan is diagrammatic only, and distances scaled from this plan may not be accurate. Please read all conditions and information on the attached information sheet. This extract is subject to those conditions. The information contained on this plan is only valid for 28 days from the date of issue.

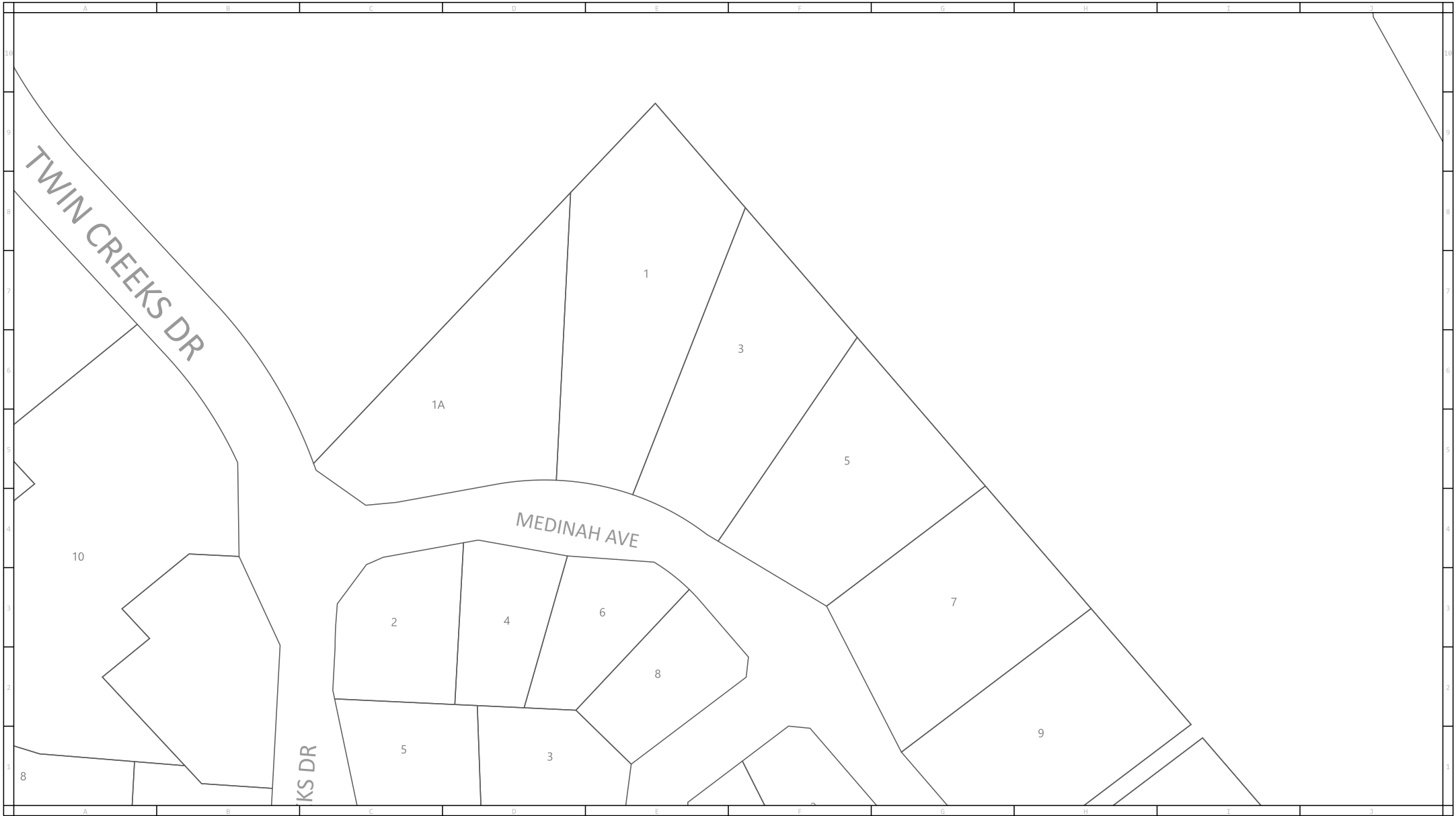

For legend details, please refer to the Coversheet attachment provided as part of this DBYD response.

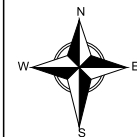

Scale: 1:2000

Issue Date: 07/01/2021

DBYD Seq No: 105303053

DBYD Job No: 20857103

0m 10m 20m 30m 40m 50m 60m 70m 80m



WARNING: This is a representation of Jemena Gas Networks underground assets only and may not indicate all assets in the area. It must not be used for the purpose of exact asset location in order to undertake any type of excavation. This plan is diagrammatic only, and distances scaled from this plan may not be accurate. Please read all conditions and information on the attached information sheet. This extract is subject to those conditions. The information contained on this plan is only valid for 28 days from the date of issue.

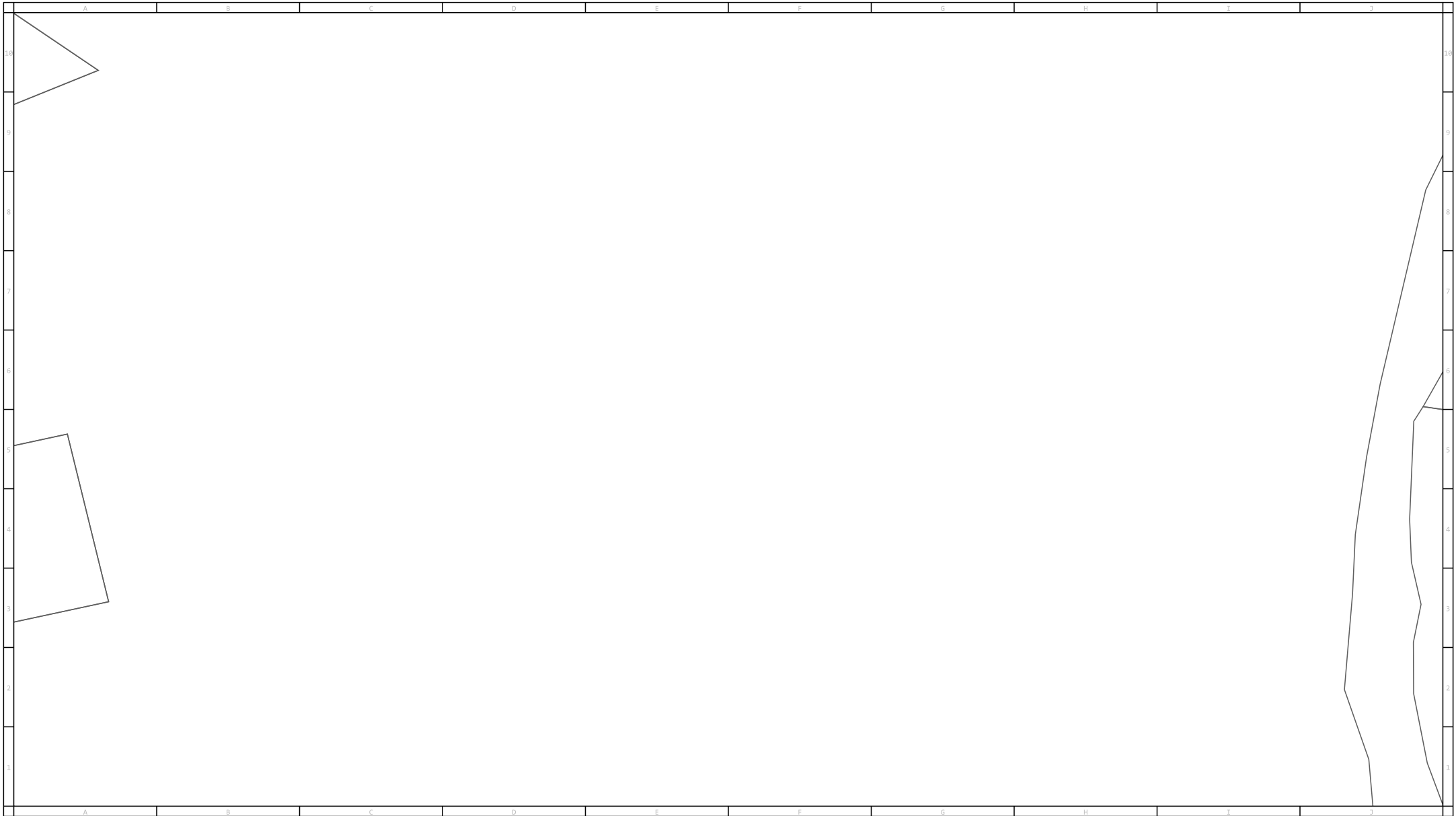

For legend details, please refer to the Coversheet attachment provided as part of this DBYD response.

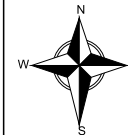

Scale: 1:2000

Issue Date: 07/01/2021

DBYD Seq No: 105303053

DBYD Job No: 20857103

0m 10m 20m 30m 40m 50m 60m 70m 80m



WARNING: This is a representation of Jemena Gas Networks underground assets only and may not indicate all assets in the area. It must not be used for the purpose of exact asset location in order to undertake any type of excavation. This plan is diagrammatic only, and distances scaled from this plan may not be accurate. Please read all conditions and information on the attached information sheet. This extract is subject to those conditions. The information contained on this plan is only valid for 28 days from the date of issue.

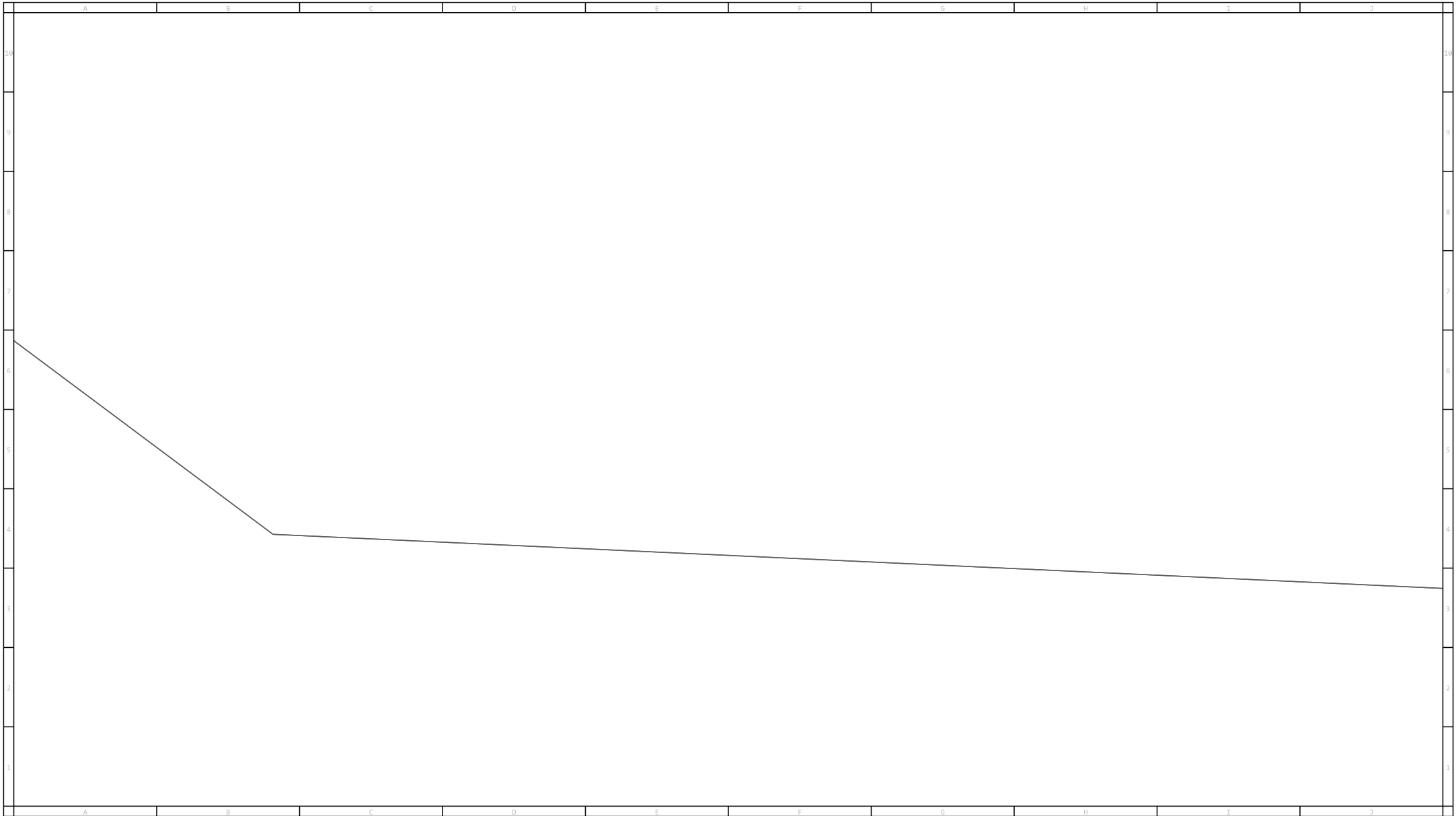

For legend details, please refer to the Coversheet attachment provided as part of this DBYD response.

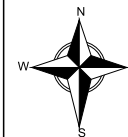

Scale: 1:2000

Issue Date: 07/01/2021

DBYD Seq No: 105303053

DBYD Job No: 20857103

0m 10m 20m 30m 40m 50m 60m 70m 80m



WARNING: This is a representation of Jemena Gas Networks underground assets only and may not indicate all assets in the area. It must not be used for the purpose of exact asset location in order to undertake any type of excavation. This plan is diagrammatic only, and distances scaled from this plan may not be accurate. Please read all conditions and information on the attached information sheet. This extract is subject to those conditions. The information contained on this plan is only valid for 28 days from the date of issue.

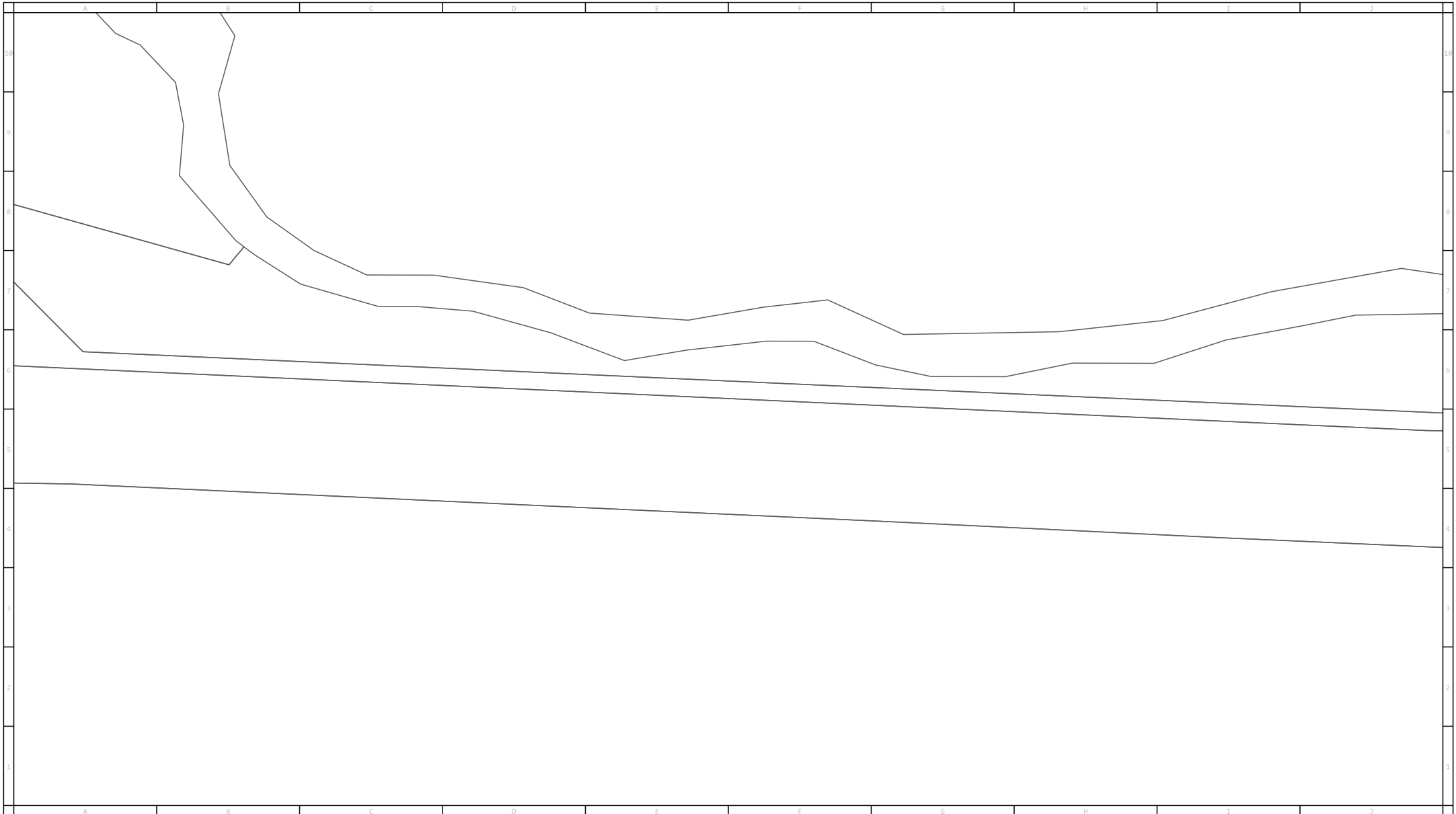

For legend details, please refer to the Coversheet attachment provided as part of this DBYD response.

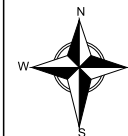

Scale: 1:2000

Issue Date: 07/01/2021

DBYD Seq No: 105303053

DBYD Job No: 20857103

0m 10m 20m 30m 40m 50m 60m 70m 80m



WARNING: This is a representation of Jemena Gas Networks underground assets only and may not indicate all assets in the area. It must not be used for the purpose of exact asset location in order to undertake any type of excavation. This plan is diagrammatic only, and distances scaled from this plan may not be accurate. Please read all conditions and information on the attached information sheet. This extract is subject to those conditions. The information contained on this plan is only valid for 28 days from the date of issue.

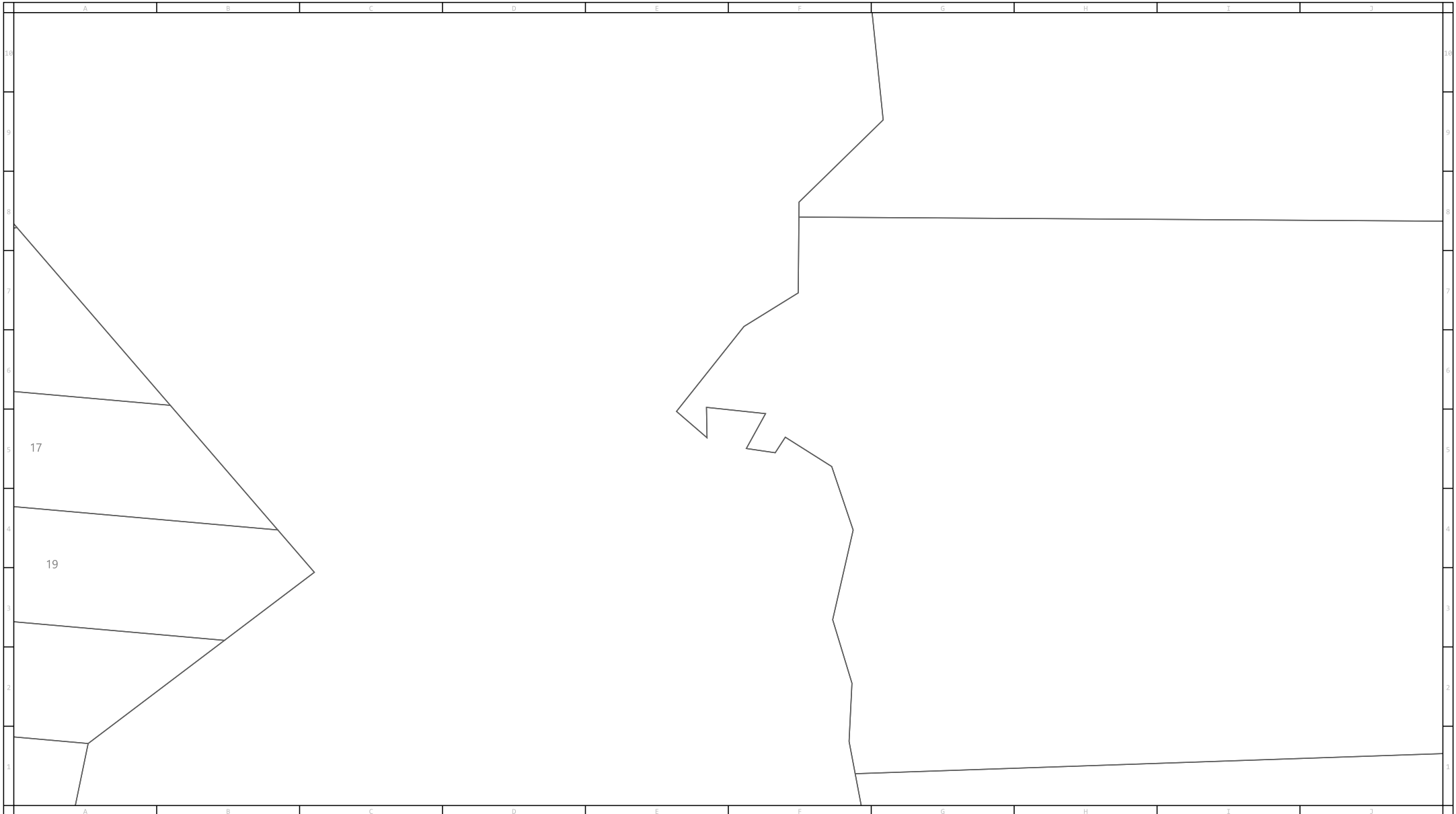

For legend details, please refer to the Coversheet attachment provided as part of this DBYD response.

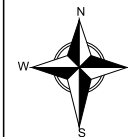

Scale: 1:2000

Issue Date: 07/01/2021

DBYD Seq No: 105303053

DBYD Job No: 20857103

0m 10m 20m 30m 40m 50m 60m 70m 80m



WARNING: This is a representation of Jemena Gas Networks underground assets only and may not indicate all assets in the area. It must not be used for the purpose of exact asset location in order to undertake any type of excavation. This plan is diagrammatic only, and distances scaled from this plan may not be accurate. Please read all conditions and information on the attached information sheet. This extract is subject to those conditions. The information contained on this plan is only valid for 28 days from the date of issue.

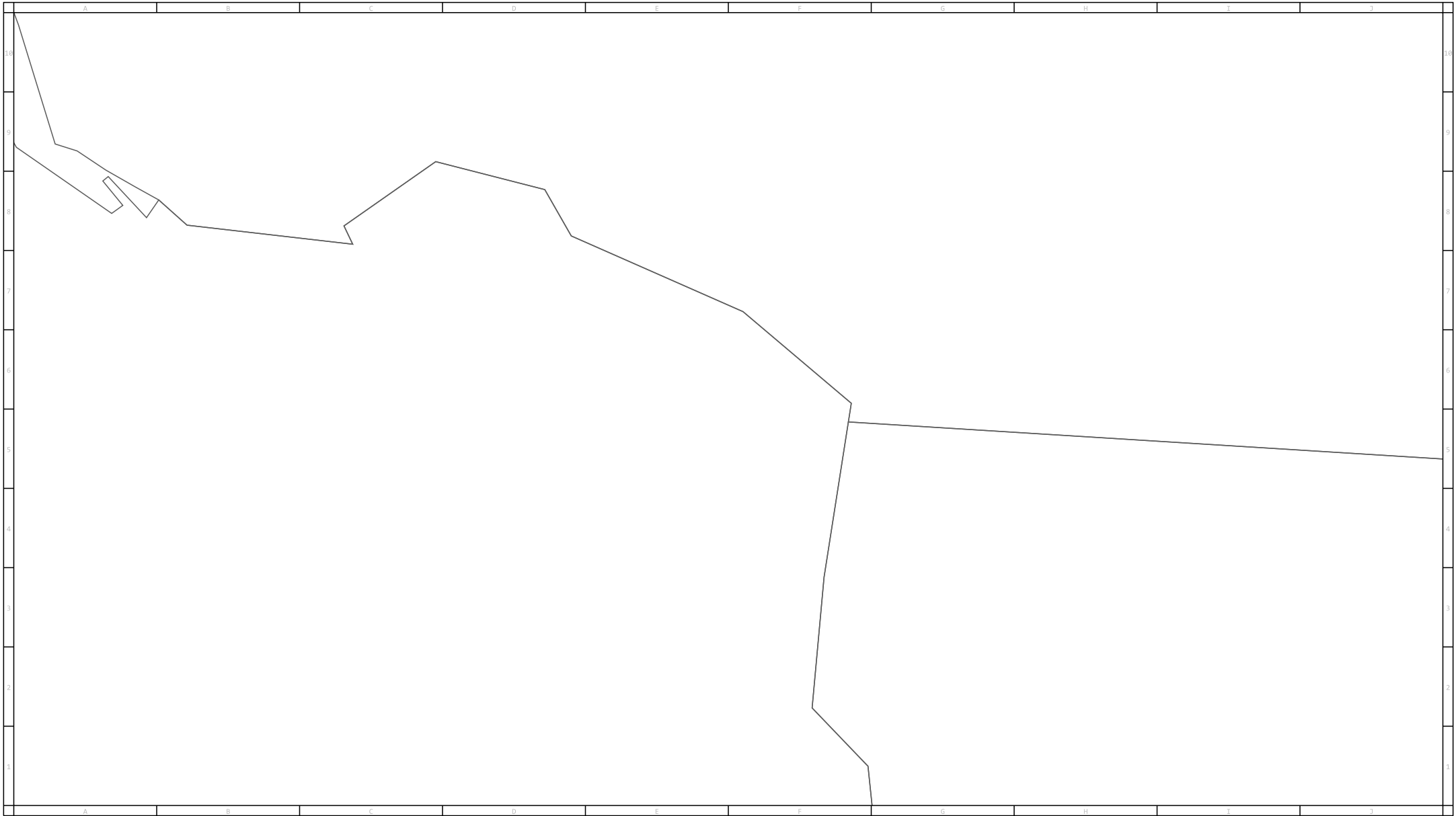

For legend details, please refer to the Coversheet attachment provided as part of this DBYD response.

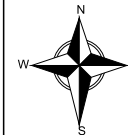

Scale: 1:2000

Issue Date: 07/01/2021

DBYD Seq No: 105303053

DBYD Job No: 20857103

0m 10m 20m 30m 40m 50m 60m 70m 80m



WARNING: This is a representation of Jemena Gas Networks underground assets only and may not indicate all assets in the area. It must not be used for the purpose of exact asset location in order to undertake any type of excavation. This plan is diagrammatic only, and distances scaled from this plan may not be accurate. Please read all conditions and information on the attached information sheet. This extract is subject to those conditions. The information contained on this plan is only valid for 28 days from the date of issue.

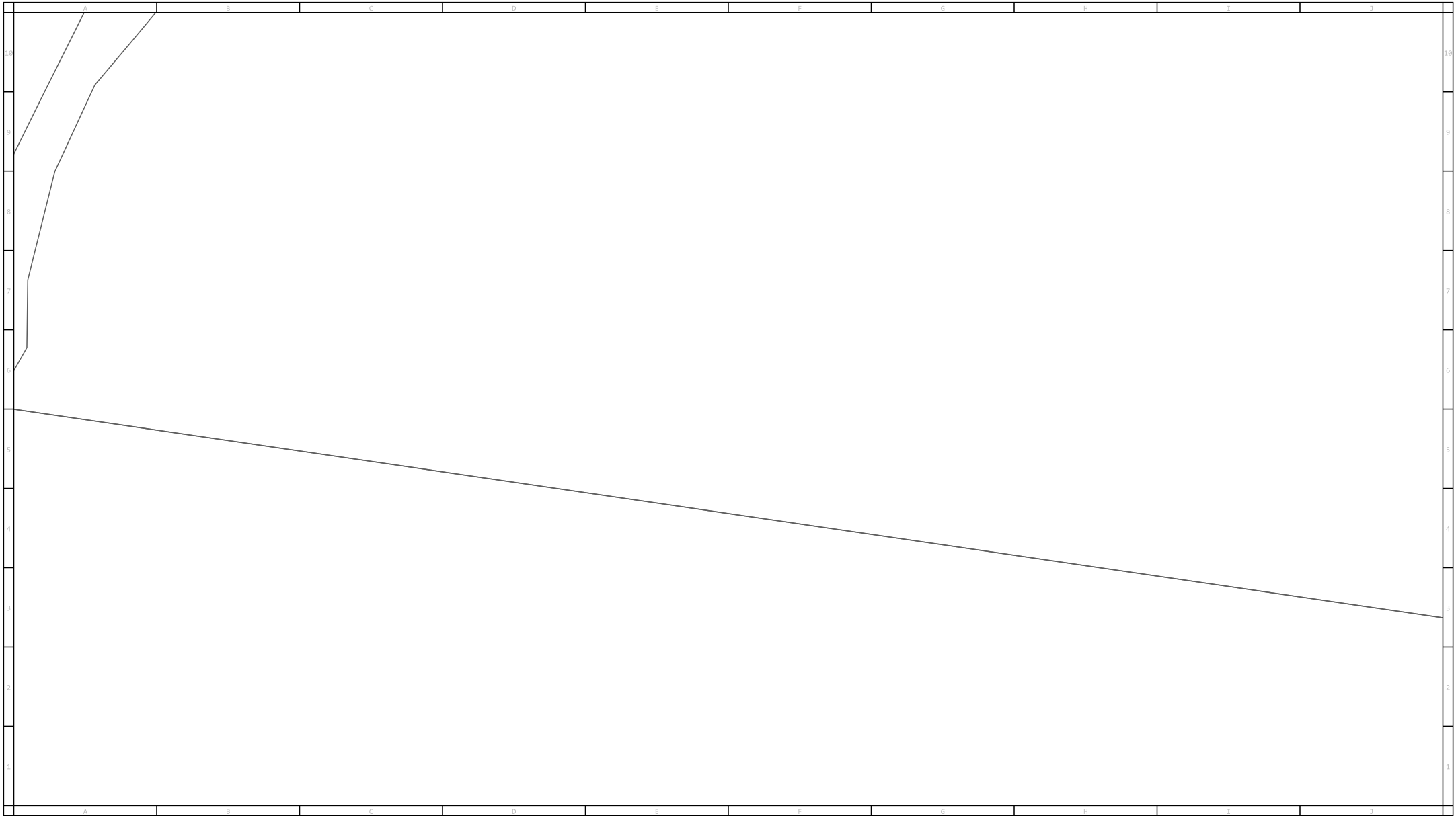

For legend details, please refer to the Coversheet attachment provided as part of this DBYD response.

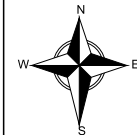

Scale: 1:2000

Issue Date: 07/01/2021

DBYD Seq No: 105303053

DBYD Job No: 20857103

0m 10m 20m 30m 40m 50m 60m 70m 80m



WARNING: This is a representation of Jemena Gas Networks underground assets only and may not indicate all assets in the area. It must not be used for the purpose of exact asset location in order to undertake any type of excavation. This plan is diagrammatic only, and distances scaled from this plan may not be accurate. Please read all conditions and information on the attached information sheet. This extract is subject to those conditions. The information contained on this plan is only valid for 28 days from the date of issue.

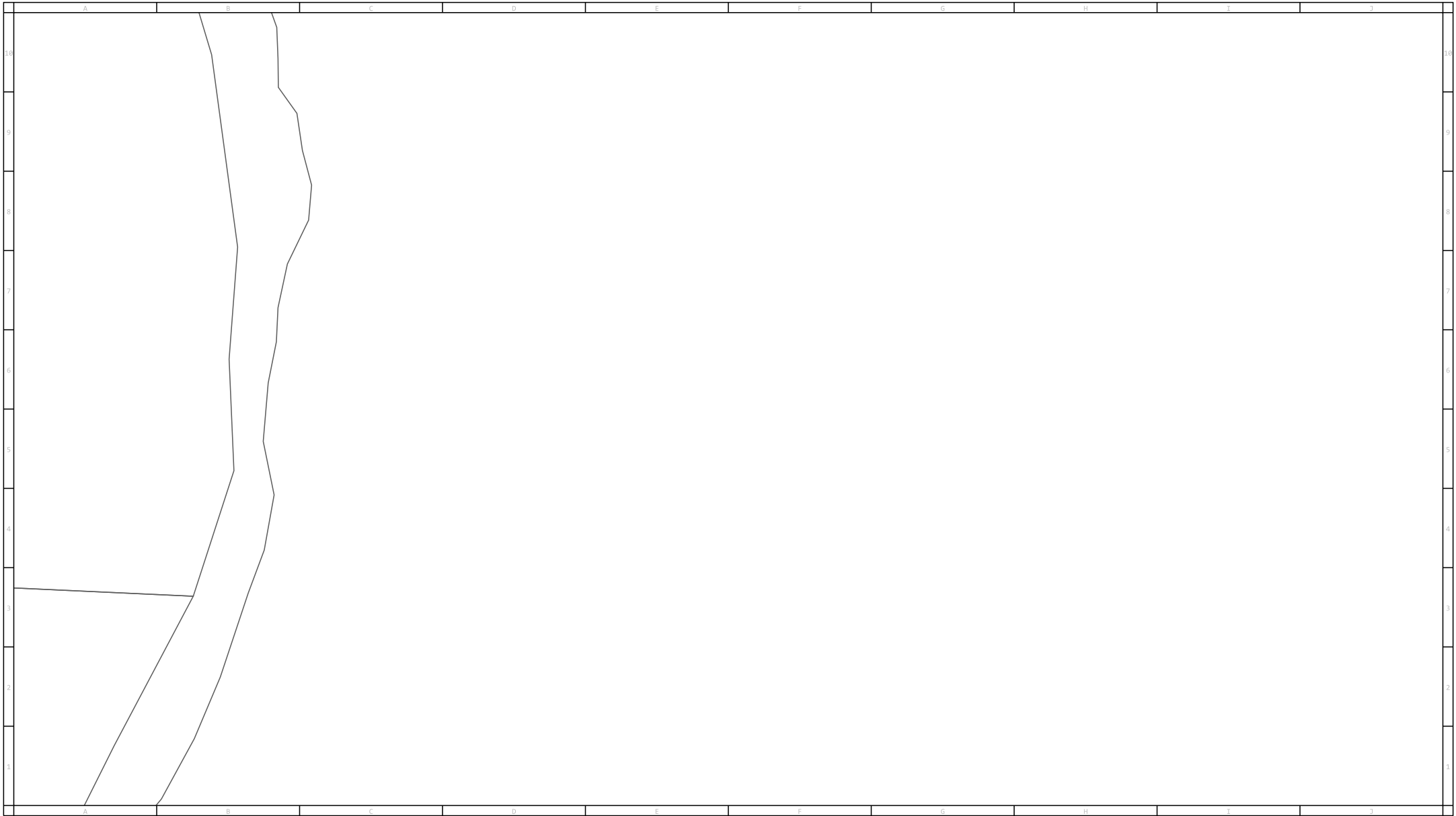

For legend details, please refer to the Coversheet attachment provided as part of this DBYD response.

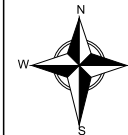

Scale: 1:2000

Issue Date: 07/01/2021

DBYD Seq No: 105303053

DBYD Job No: 20857103

0m 10m 20m 30m 40m 50m 60m 70m 80m



WARNING: This is a representation of Jemena Gas Networks underground assets only and may not indicate all assets in the area. It must not be used for the purpose of exact asset location in order to undertake any type of excavation. This plan is diagrammatic only, and distances scaled from this plan may not be accurate. Please read all conditions and information on the attached information sheet. This extract is subject to those conditions. The information contained on this plan is only valid for 28 days from the date of issue.

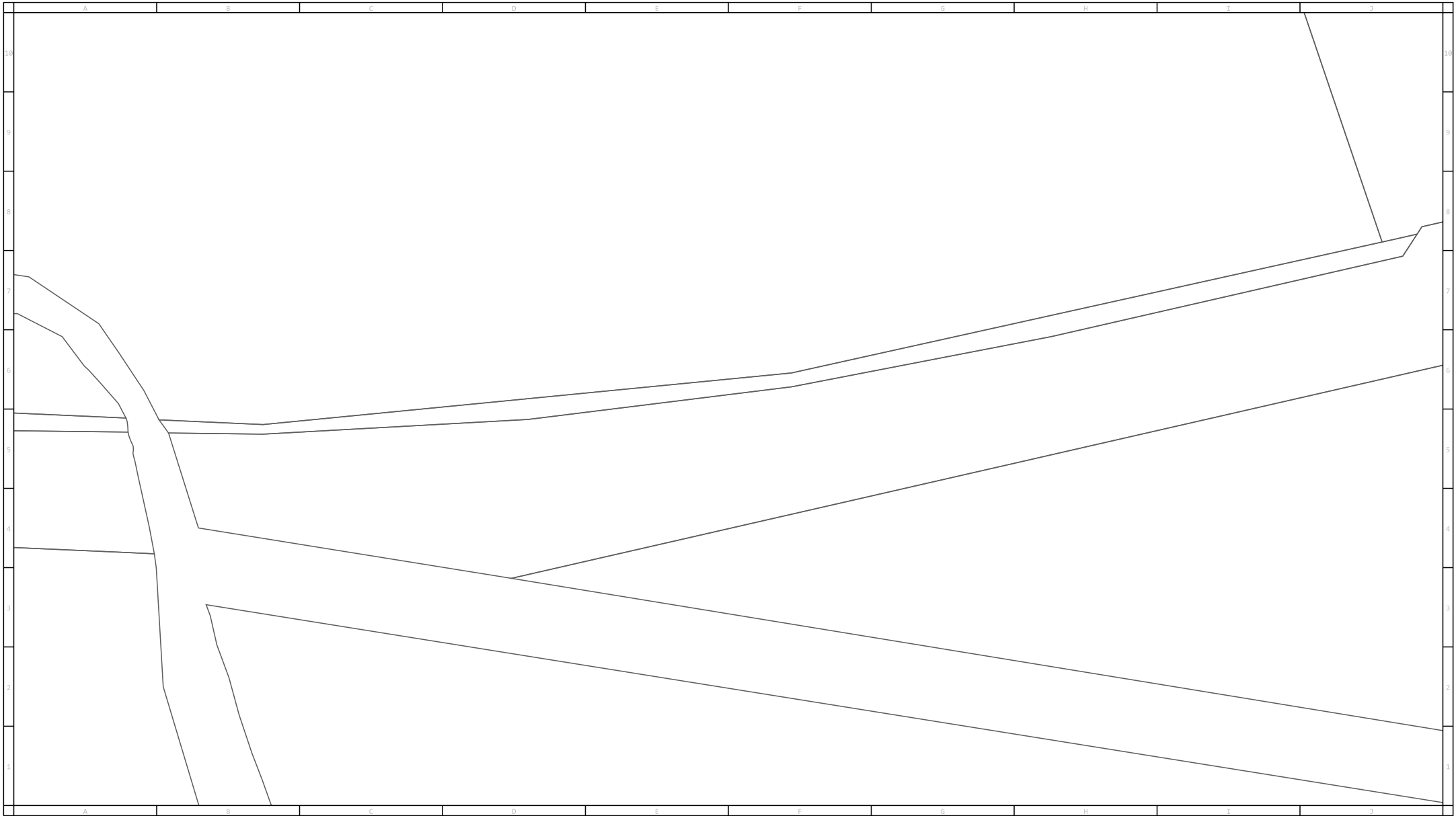

For legend details, please refer to the Coversheet attachment provided as part of this DBYD response.

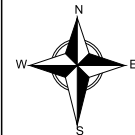

Scale: 1:2000

Issue Date: 07/01/2021

DBYD Seq No: 105303053

DBYD Job No: 20857103

0m 10m 20m 30m 40m 50m 60m 70m 80m



WARNING: This is a representation of Jemena Gas Networks underground assets only and may not indicate all assets in the area. It must not be used for the purpose of exact asset location in order to undertake any type of excavation. This plan is diagrammatic only, and distances scaled from this plan may not be accurate. Please read all conditions and information on the attached information sheet. This extract is subject to those conditions. The information contained on this plan is only valid for 28 days from the date of issue.

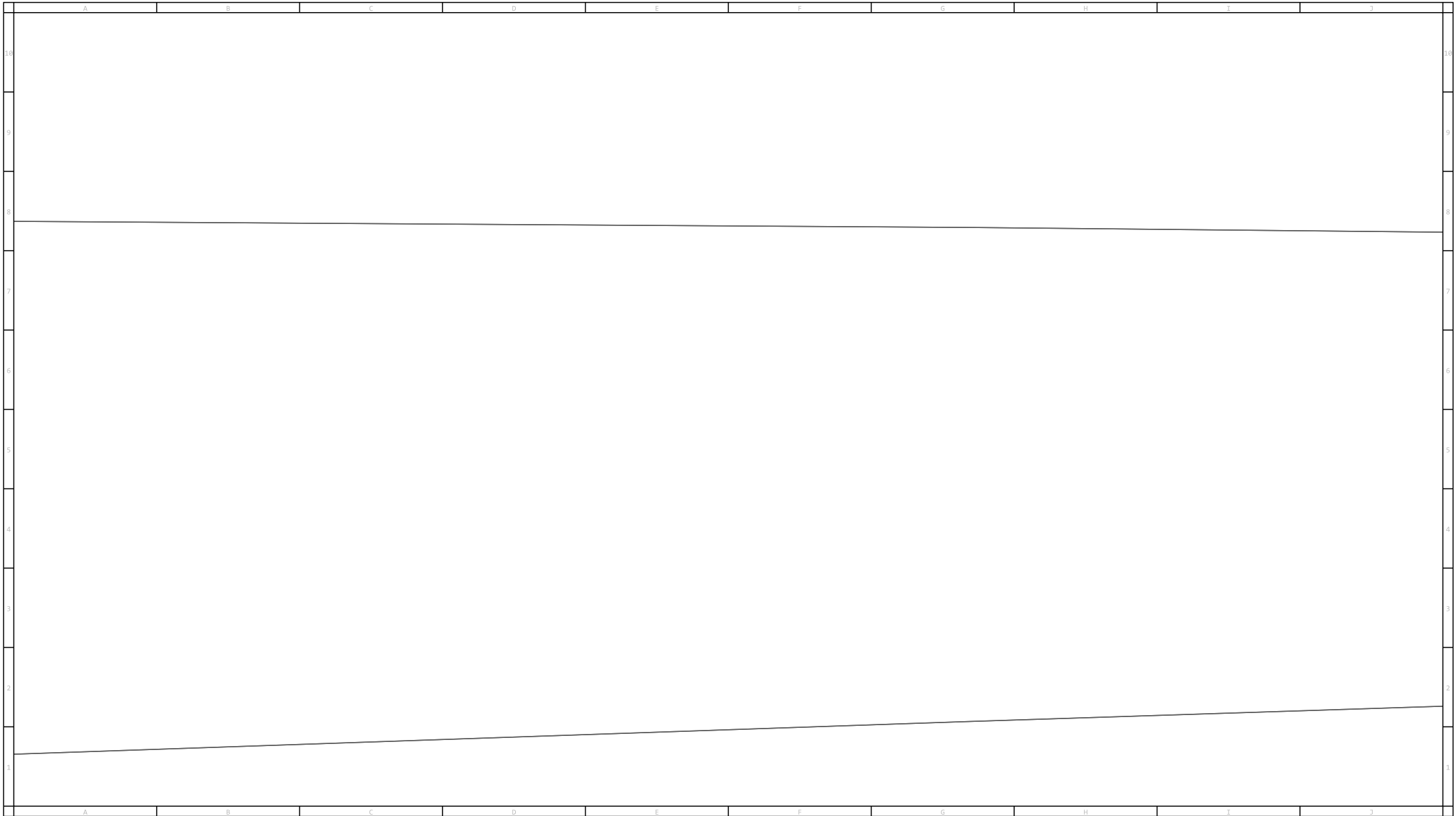

For legend details, please refer to the Coversheet attachment provided as part of this DBYD response.

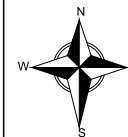

Scale: 1:2000

Issue Date: 07/01/2021

DBYD Seq No: 105303053

DBYD Job No: 20857103

0m 10m 20m 30m 40m 50m 60m 70m 80m



WARNING: This is a representation of Jemena Gas Networks underground assets only and may not indicate all assets in the area. It must not be used for the purpose of exact asset location in order to undertake any type of excavation. This plan is diagrammatic only, and distances scaled from this plan may not be accurate. Please read all conditions and information on the attached information sheet. This extract is subject to those conditions. The information contained on this plan is only valid for 28 days from the date of issue.

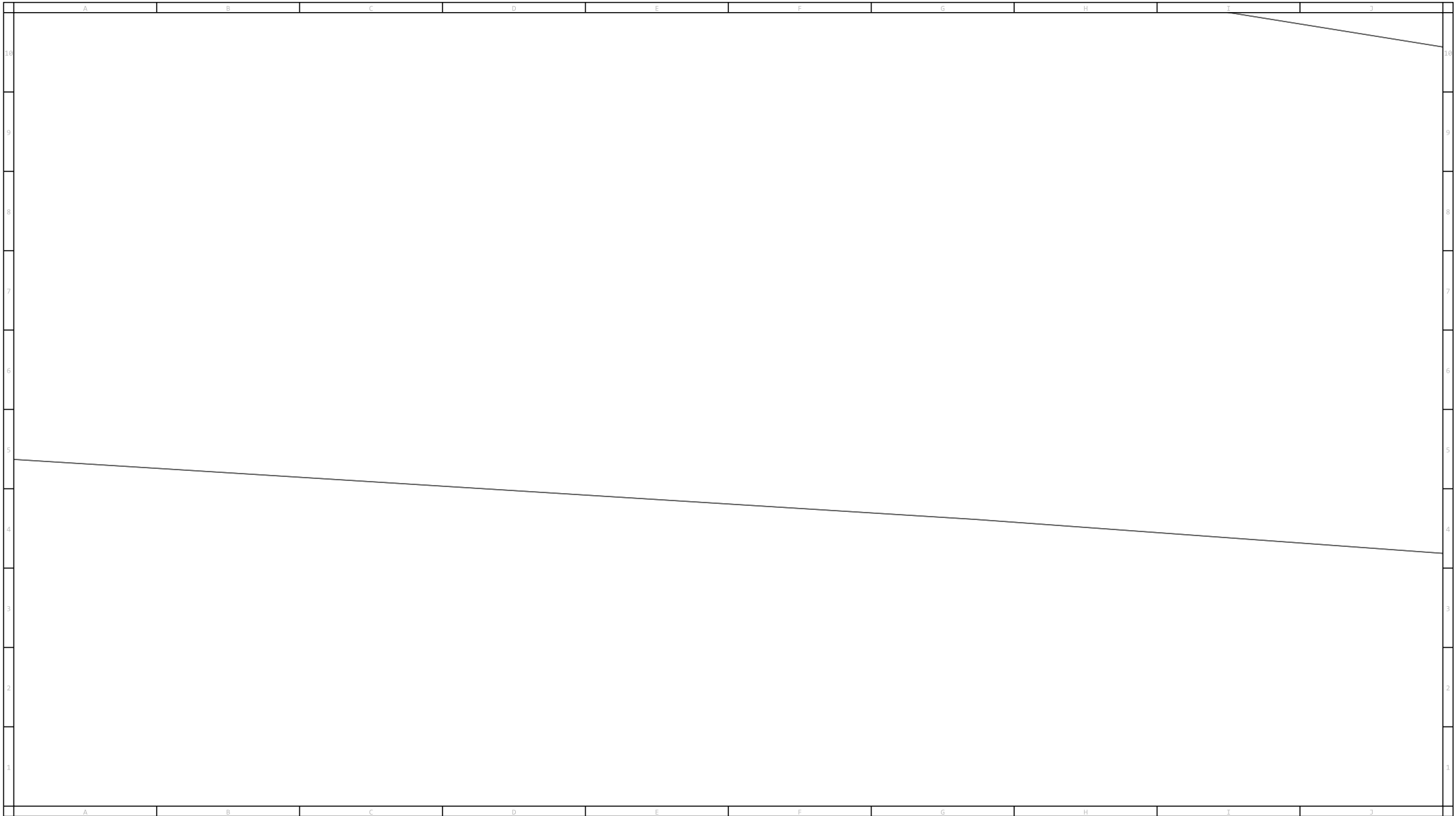

For legend details, please refer to the Coversheet attachment provided as part of this DBYD response.

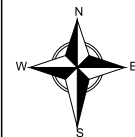

Scale: 1:2000

Issue Date: 07/01/2021

DBYD Seq No: 105303053

DBYD Job No: 20857103

0m 10m 20m 30m 40m 50m 60m 70m 80m



WARNING: This is a representation of Jemena Gas Networks underground assets only and may not indicate all assets in the area. It must not be used for the purpose of exact asset location in order to undertake any type of excavation. This plan is diagrammatic only, and distances scaled from this plan may not be accurate. Please read all conditions and information on the attached information sheet. This extract is subject to those conditions. The information contained on this plan is only valid for 28 days from the date of issue.

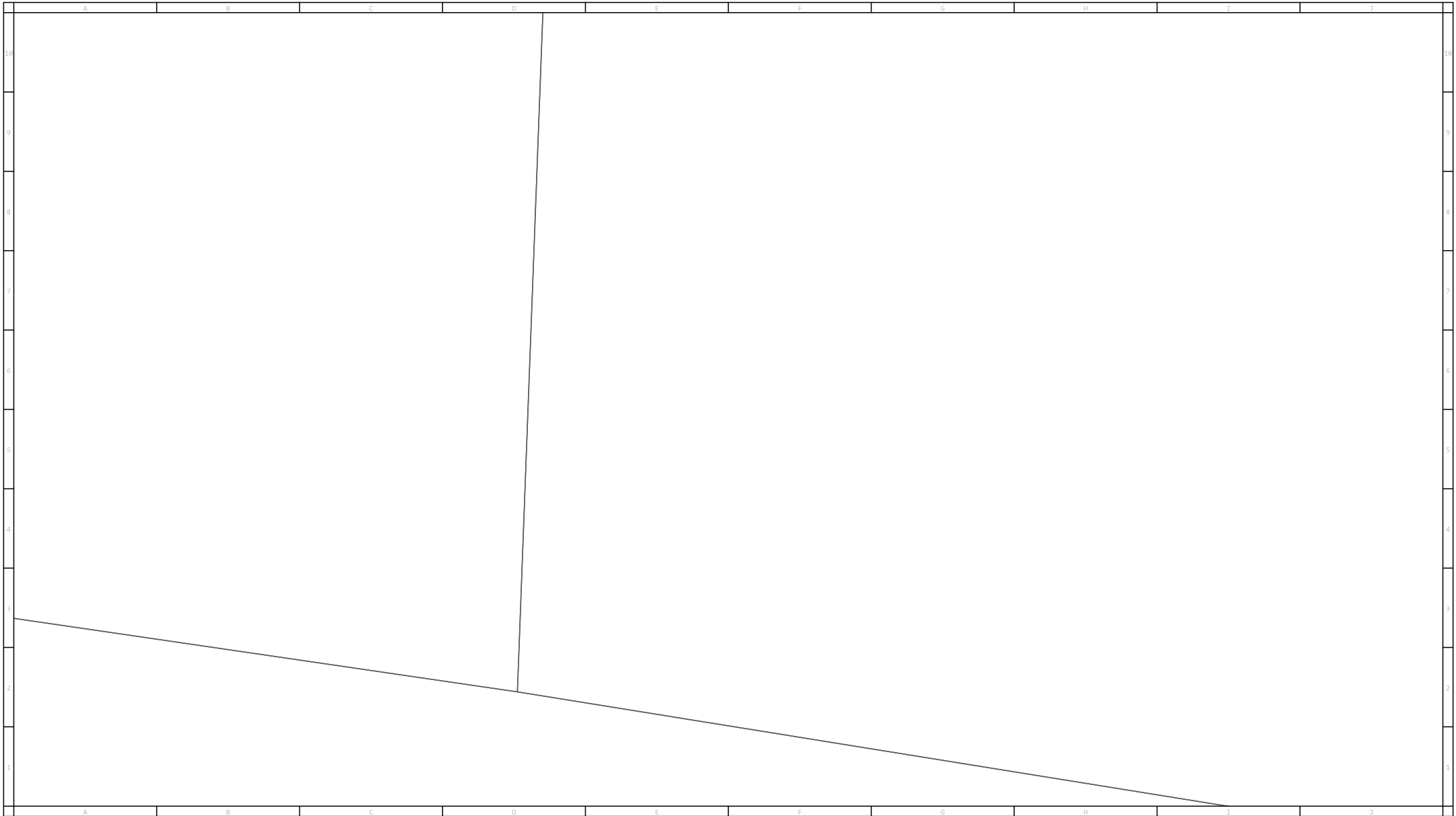

For legend details, please refer to the Coversheet attachment provided as part of this DBYD response.

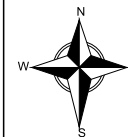

Scale: 1:2000

Issue Date: 07/01/2021

DBYD Seq No: 105303053

DBYD Job No: 20857103

0m 10m 20m 30m 40m 50m 60m 70m 80m



WARNING: This is a representation of Jemena Gas Networks underground assets only and may not indicate all assets in the area. It must not be used for the purpose of exact asset location in order to undertake any type of excavation. This plan is diagrammatic only, and distances scaled from this plan may not be accurate. Please read all conditions and information on the attached information sheet. This extract is subject to those conditions. The information contained on this plan is only valid for 28 days from the date of issue.

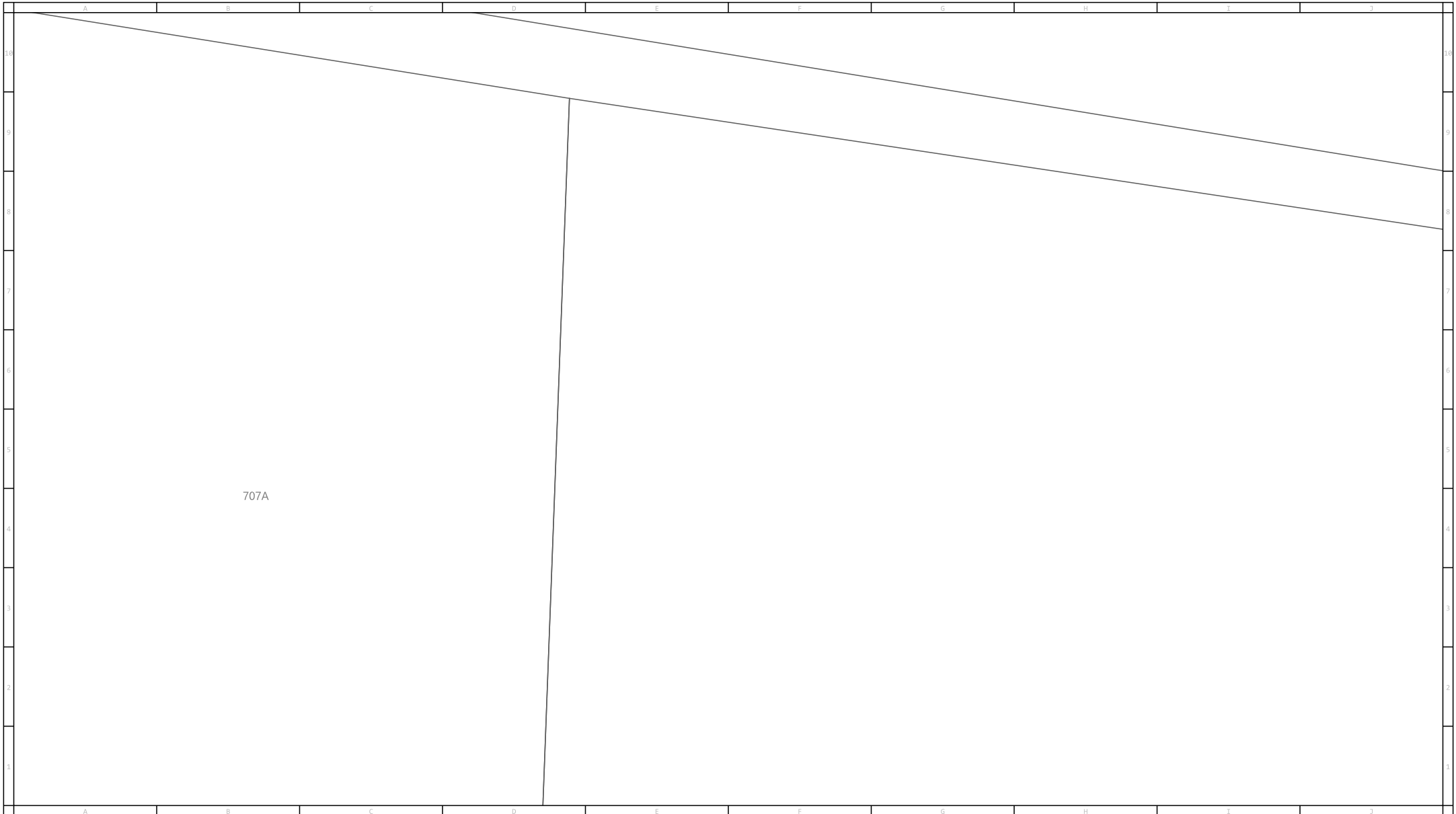

For legend details, please refer to the Coversheet attachment provided as part of this DBYD response.

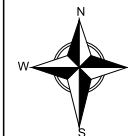

Scale: 1:2000

Issue Date: 07/01/2021

DBYD Seq No: 105303053

DBYD Job No: 20857103

0m 10m 20m 30m 40m 50m 60m 70m 80m



WARNING: This is a representation of Jemena Gas Networks underground assets only and may not indicate all assets in the area. It must not be used for the purpose of exact asset location in order to undertake any type of excavation. This plan is diagrammatic only, and distances scaled from this plan may not be accurate. Please read all conditions and information on the attached information sheet. This extract is subject to those conditions. The information contained on this plan is only valid for 28 days from the date of issue.

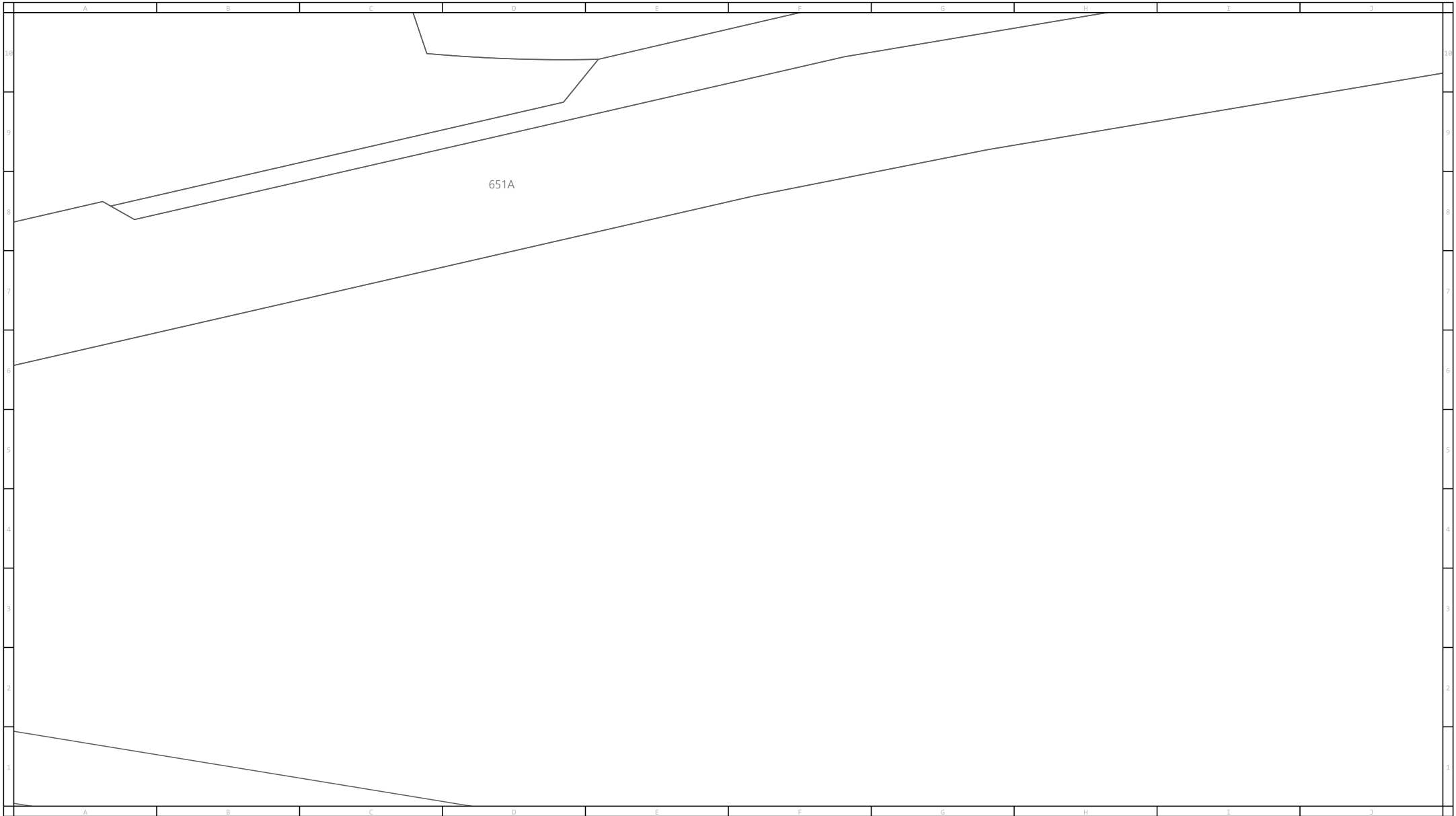

For legend details, please refer to the Coversheet attachment provided as part of this DBYD response.

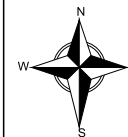

Scale: 1:2000

Issue Date: 07/01/2021

DBYD Seq No: 105303053

DBYD Job No: 20857103

0m 10m 20m 30m 40m 50m 60m 70m 80m



WARNING: This is a representation of Jemena Gas Networks underground assets only and may not indicate all assets in the area. It must not be used for the purpose of exact asset location in order to undertake any type of excavation. This plan is diagrammatic only, and distances scaled from this plan may not be accurate. Please read all conditions and information on the attached information sheet. This extract is subject to those conditions. The information contained on this plan is only valid for 28 days from the date of issue.

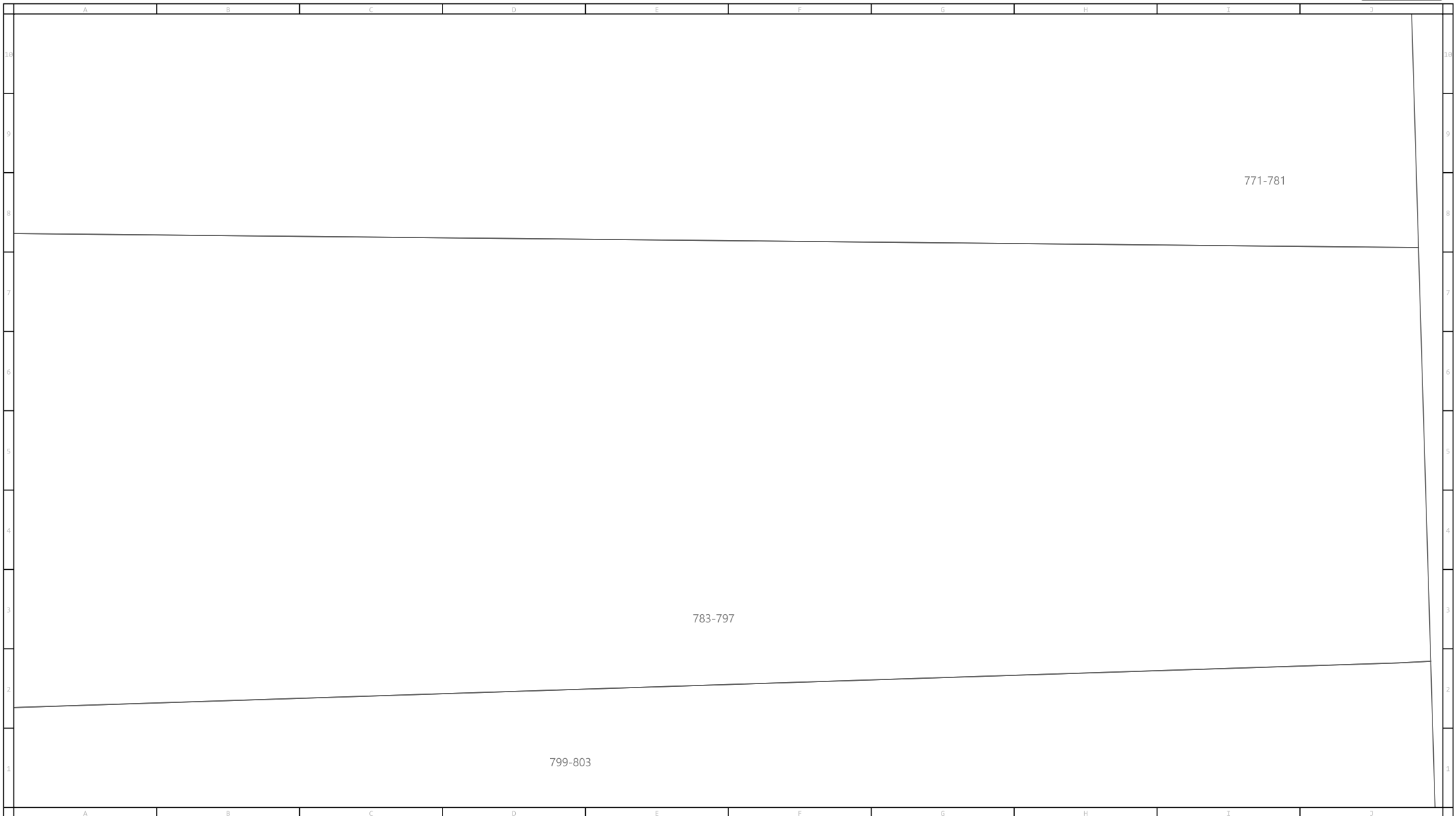

For legend details, please refer to the Coversheet attachment provided as part of this DBYD response.

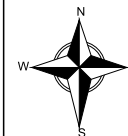

Scale: 1:2000

Issue Date: 07/01/2021

DBYD Seq No: 105303053

DBYD Job No: 20857103

0m 10m 20m 30m 40m 50m 60m 70m 80m



WARNING: This is a representation of Jemena Gas Networks underground assets only and may not indicate all assets in the area. It must not be used for the purpose of exact asset location in order to undertake any type of excavation. This plan is diagrammatic only, and distances scaled from this plan may not be accurate. Please read all conditions and information on the attached information sheet. This extract is subject to those conditions. The information contained on this plan is only valid for 28 days from the date of issue.

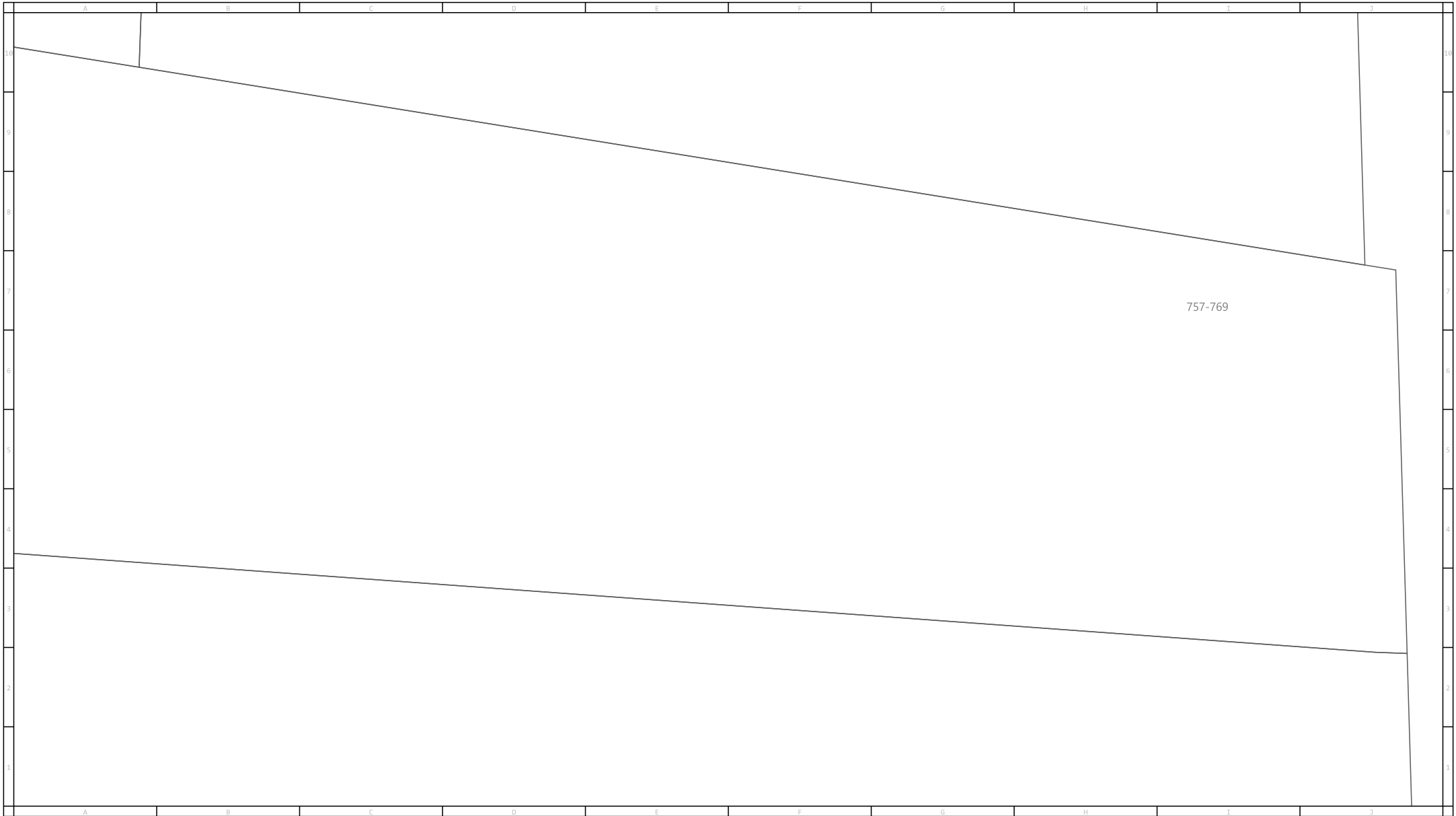

For legend details, please refer to the Coversheet attachment provided as part of this DBYD response.

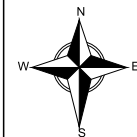

Scale: 1:2000

Issue Date: 07/01/2021

DBYD Seq No: 105303053

DBYD Job No: 20857103

0m 10m 20m 30m 40m 50m 60m 70m 80m



WARNING: This is a representation of Jemena Gas Networks underground assets only and may not indicate all assets in the area. It must not be used for the purpose of exact asset location in order to undertake any type of excavation. This plan is diagrammatic only, and distances scaled from this plan may not be accurate. Please read all conditions and information on the attached information sheet. This extract is subject to those conditions. The information contained on this plan is only valid for 28 days from the date of issue.

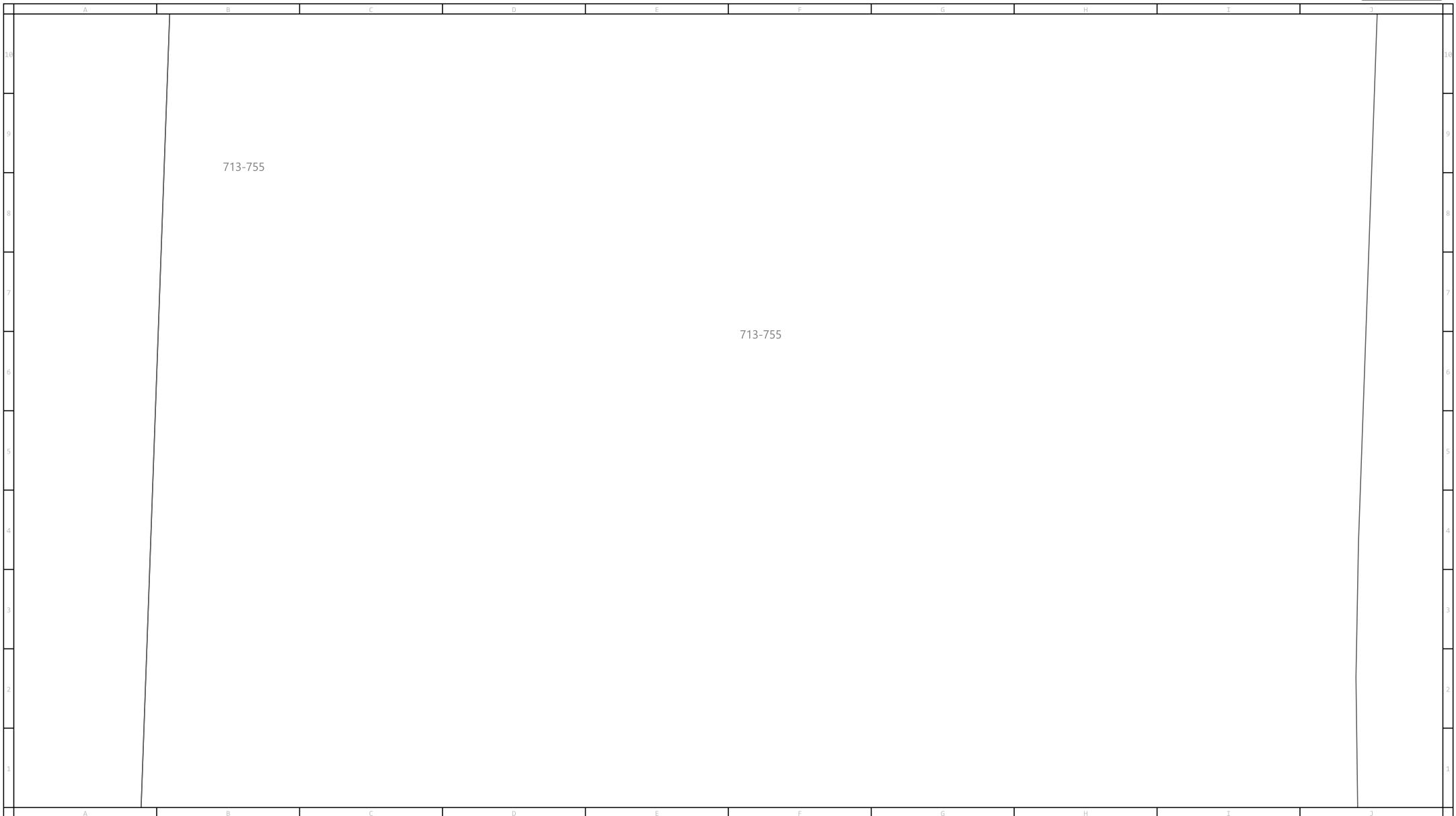

For legend details, please refer to the Coversheet attachment provided as part of this DBYD response.

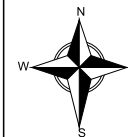

Scale: 1:2000

Issue Date: 07/01/2021

DBYD Seq No: 105303053

DBYD Job No: 20857103

0m 10m 20m 30m 40m 50m 60m 70m 80m



WARNING: This is a representation of Jemena Gas Networks underground assets only and may not indicate all assets in the area. It must not be used for the purpose of exact asset location in order to undertake any type of excavation. This plan is diagrammatic only, and distances scaled from this plan may not be accurate. Please read all conditions and information on the attached information sheet. This extract is subject to those conditions. The information contained on this plan is only valid for 28 days from the date of issue.

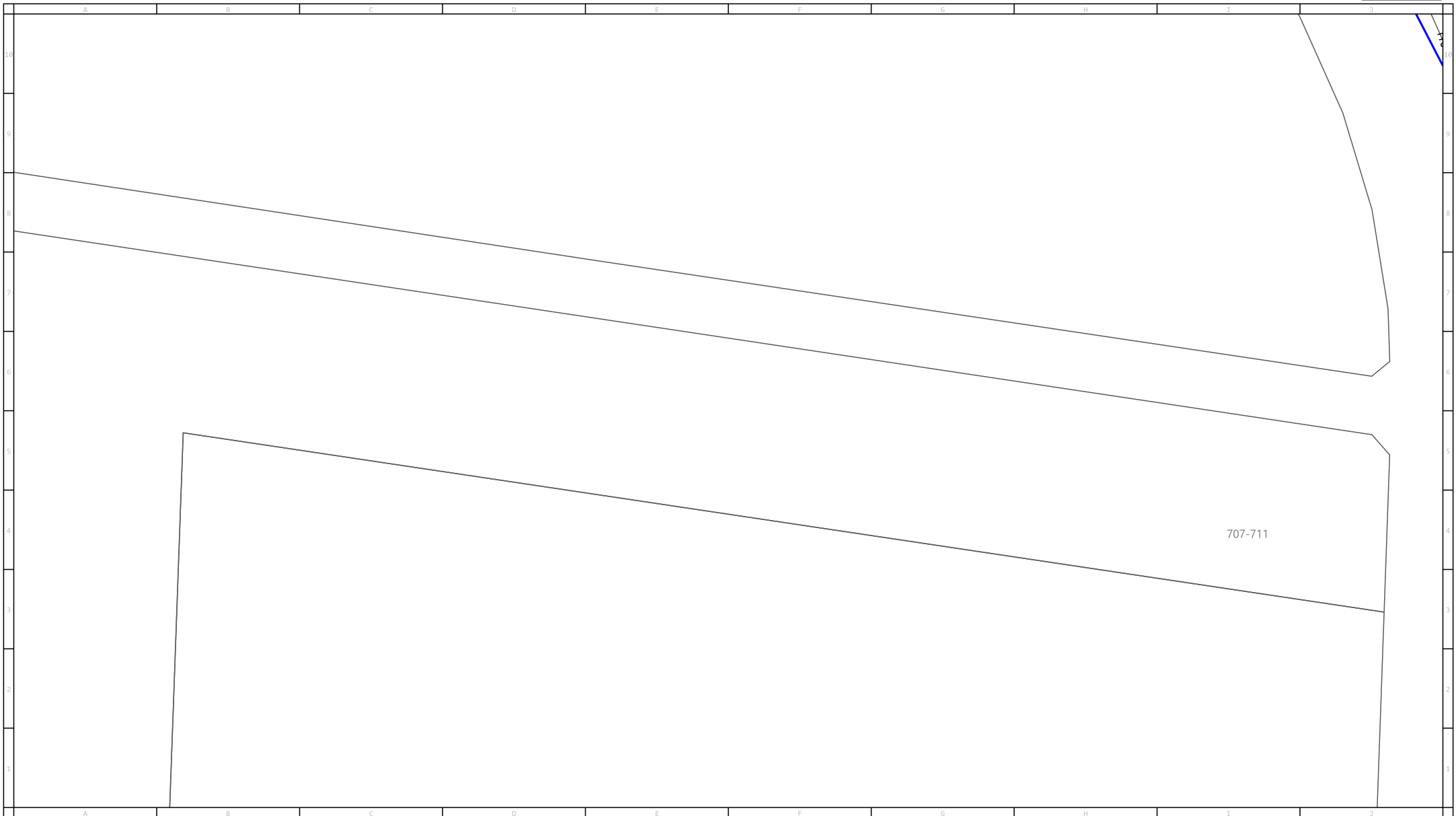

For legend details, please refer to the Coversheet attachment provided as part of this DBYD response.

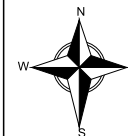

Scale: 1:2000

Issue Date: 07/01/2021

DBYD Seq No: 105303053

DBYD Job No: 20857103

0m 10m 20m 30m 40m 50m 60m 70m 80m



WARNING: This is a representation of Jemena Gas Networks underground assets only and may not indicate all assets in the area. It must not be used for the purpose of exact asset location in order to undertake any type of excavation. This plan is diagrammatic only, and distances scaled from this plan may not be accurate. Please read all conditions and information on the attached information sheet. This extract is subject to those conditions. The information contained on this plan is only valid for 28 days from the date of issue.

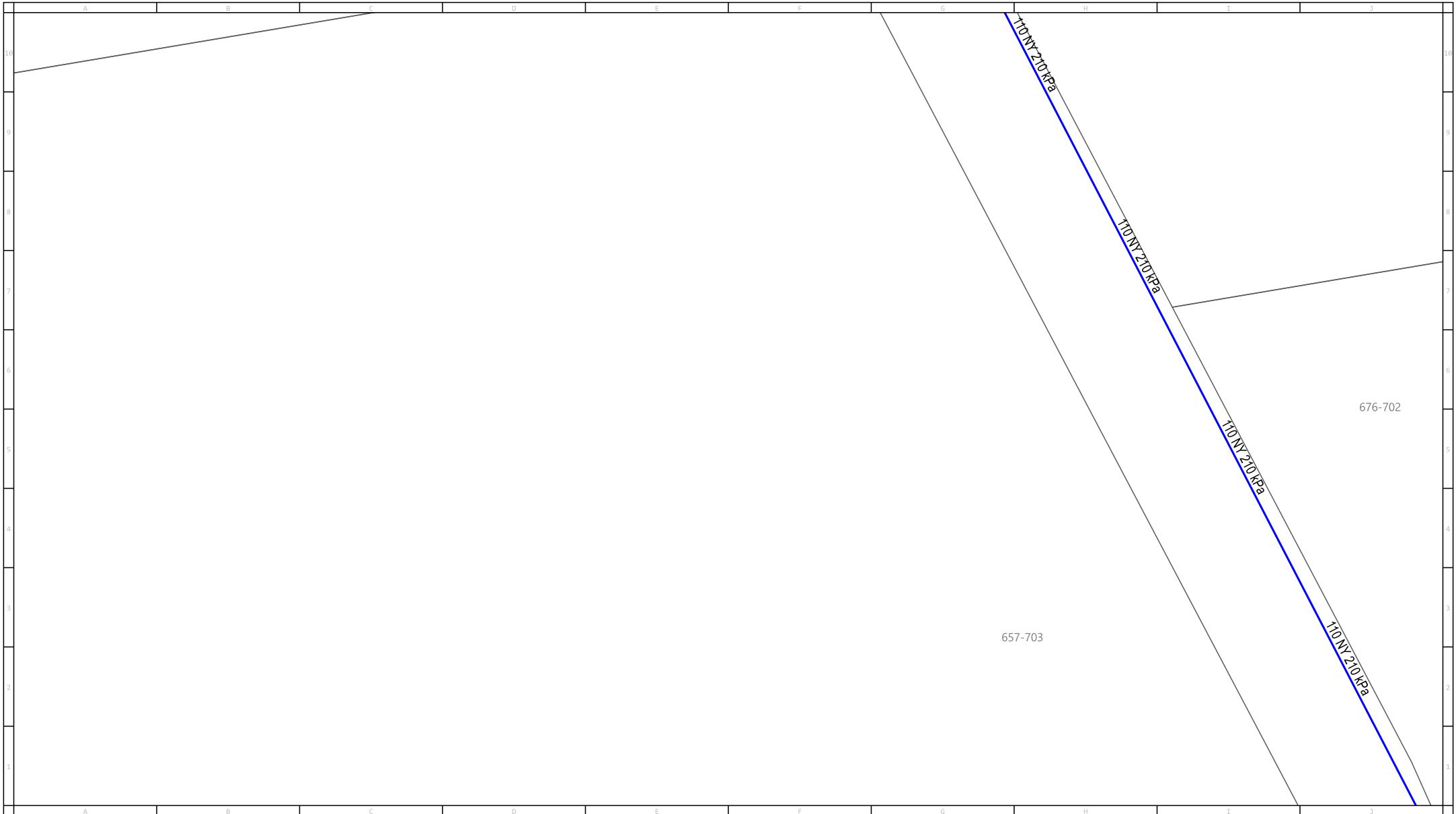

For legend details, please refer to the Coversheet attachment provided as part of this DBYD response.

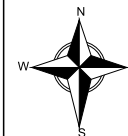

Scale: 1:2000

Issue Date: 07/01/2021

DBYD Seq No: 105303053

DBYD Job No: 20857103

0m 10m 20m 30m 40m 50m 60m 70m 80m



WARNING: This is a representation of Jemena Gas Networks underground assets only and may not indicate all assets in the area. It must not be used for the purpose of exact asset location in order to undertake any type of excavation. This plan is diagrammatic only, and distances scaled from this plan may not be accurate. Please read all conditions and information on the attached information sheet. This extract is subject to those conditions. The information contained on this plan is only valid for 28 days from the date of issue.

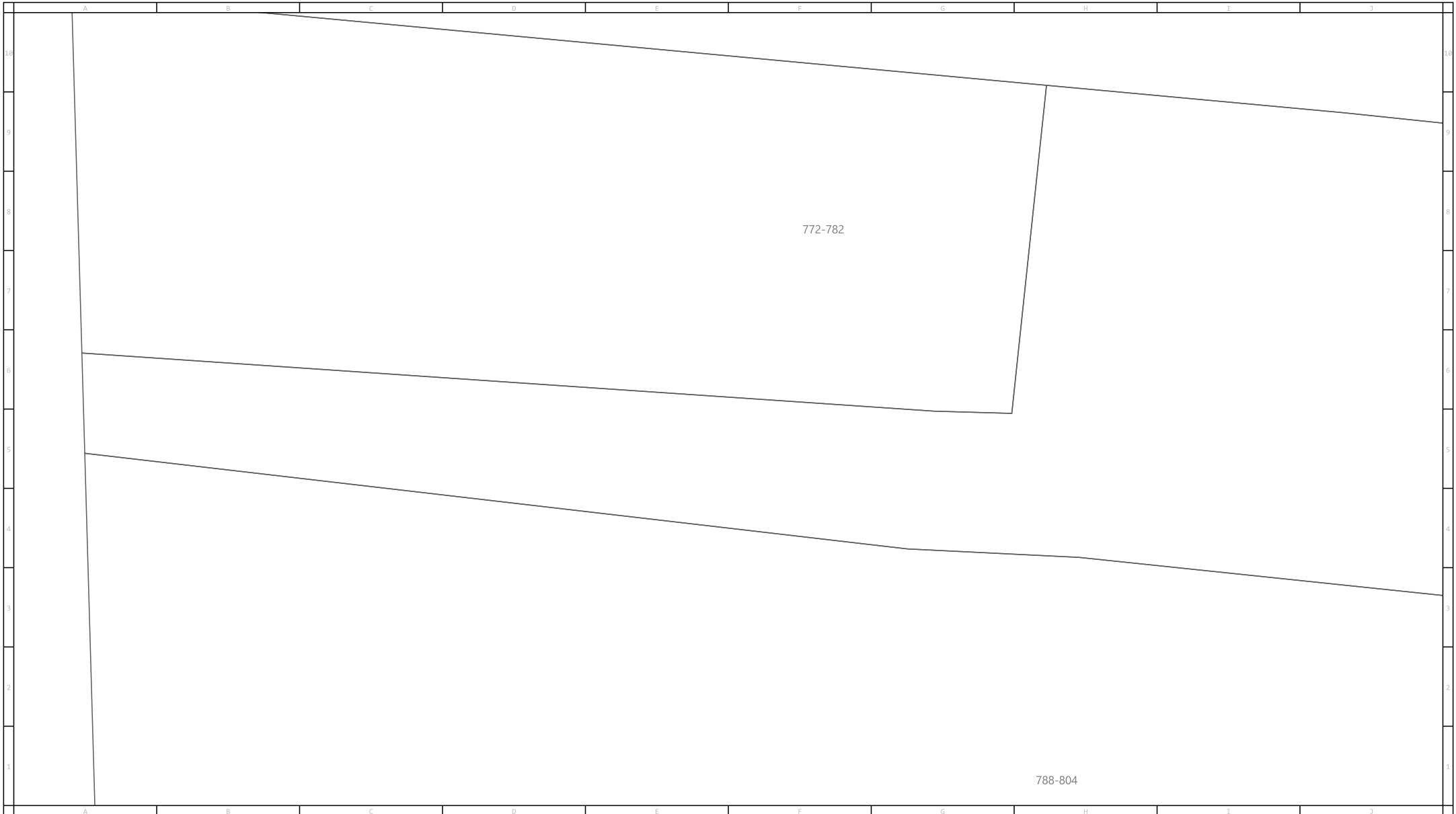

For legend details, please refer to the Coversheet attachment provided as part of this DBYD response.

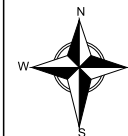

Scale: 1:2000

Issue Date: 07/01/2021

DBYD Seq No: 105303053

DBYD Job No: 20857103

0m 10m 20m 30m 40m 50m 60m 70m 80m



WARNING: This is a representation of Jemena Gas Networks underground assets only and may not indicate all assets in the area. It must not be used for the purpose of exact asset location in order to undertake any type of excavation. This plan is diagrammatic only, and distances scaled from this plan may not be accurate. Please read all conditions and information on the attached information sheet. This extract is subject to those conditions. The information contained on this plan is only valid for 28 days from the date of issue.

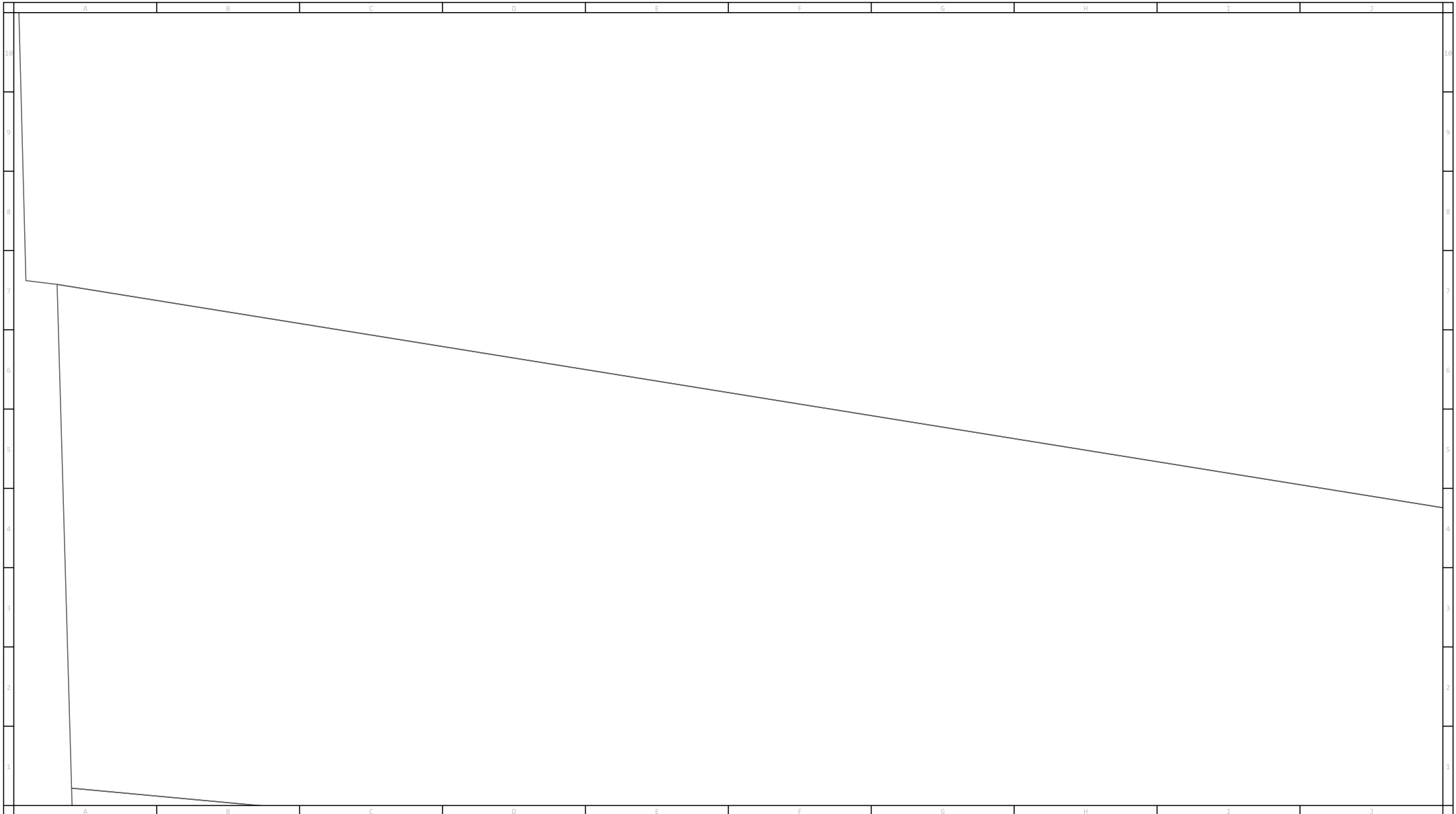

For legend details, please refer to the Coversheet attachment provided as part of this DBYD response.

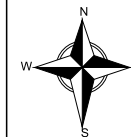

Scale: 1:2000

Issue Date: 07/01/2021

DBYD Seq No: 105303053

DBYD Job No: 20857103

0m 10m 20m 30m 40m 50m 60m 70m 80m



WARNING: This is a representation of Jemena Gas Networks underground assets only and may not indicate all assets in the area. It must not be used for the purpose of exact asset location in order to undertake any type of excavation. This plan is diagrammatic only, and distances scaled from this plan may not be accurate. Please read all conditions and information on the attached information sheet. This extract is subject to those conditions. The information contained on this plan is only valid for 28 days from the date of issue.

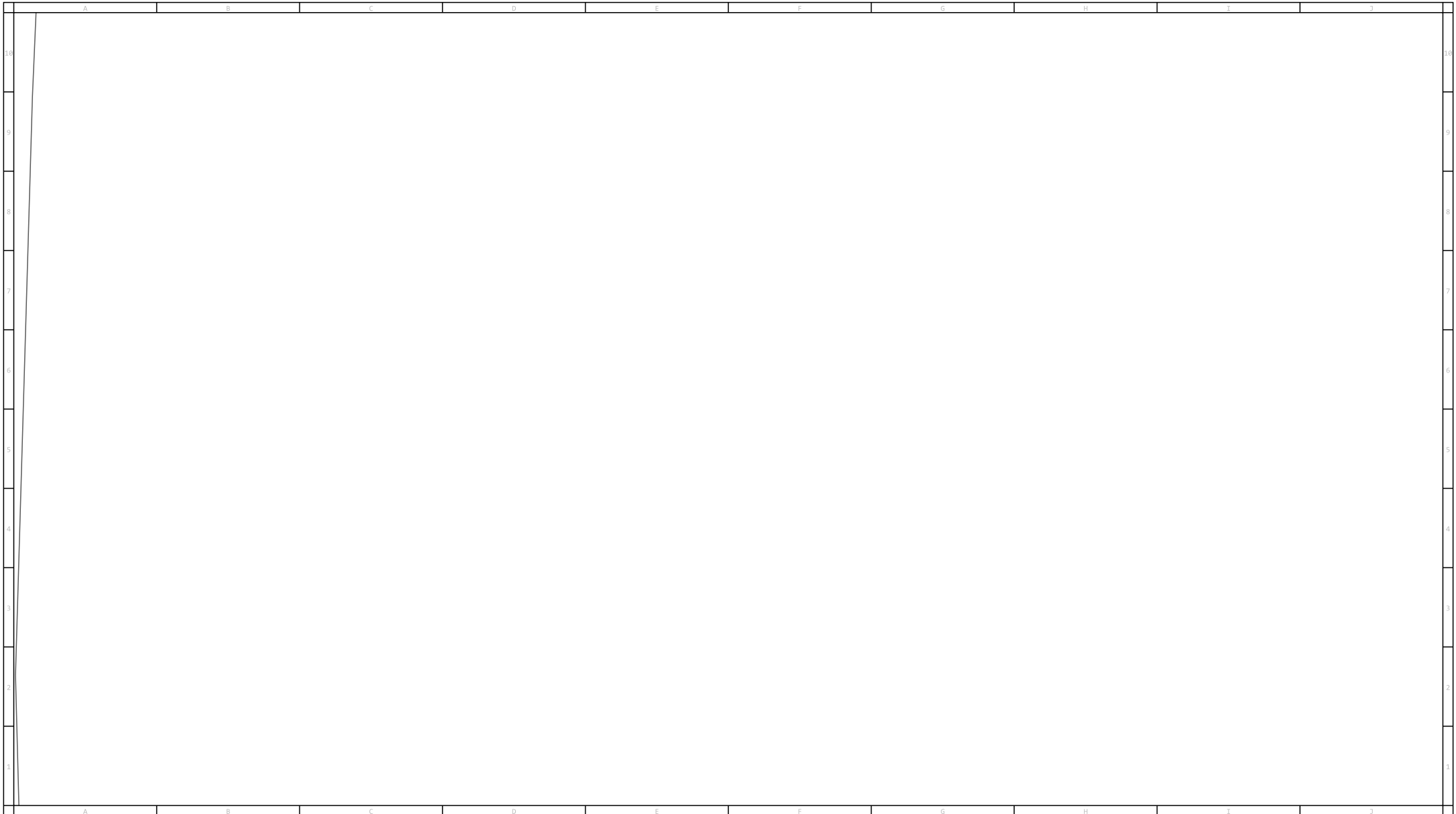

For legend details, please refer to the Coversheet attachment provided as part of this DBYD response.

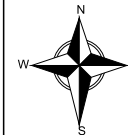

Scale: 1:2000

Issue Date: 07/01/2021

DBYD Seq No: 105303053

DBYD Job No: 20857103

0m 10m 20m 30m 40m 50m 60m 70m 80m



WARNING: This is a representation of Jemena Gas Networks underground assets only and may not indicate all assets in the area. It must not be used for the purpose of exact asset location in order to undertake any type of excavation. This plan is diagrammatic only, and distances scaled from this plan may not be accurate. Please read all conditions and information on the attached information sheet. This extract is subject to those conditions. The information contained on this plan is only valid for 28 days from the date of issue.

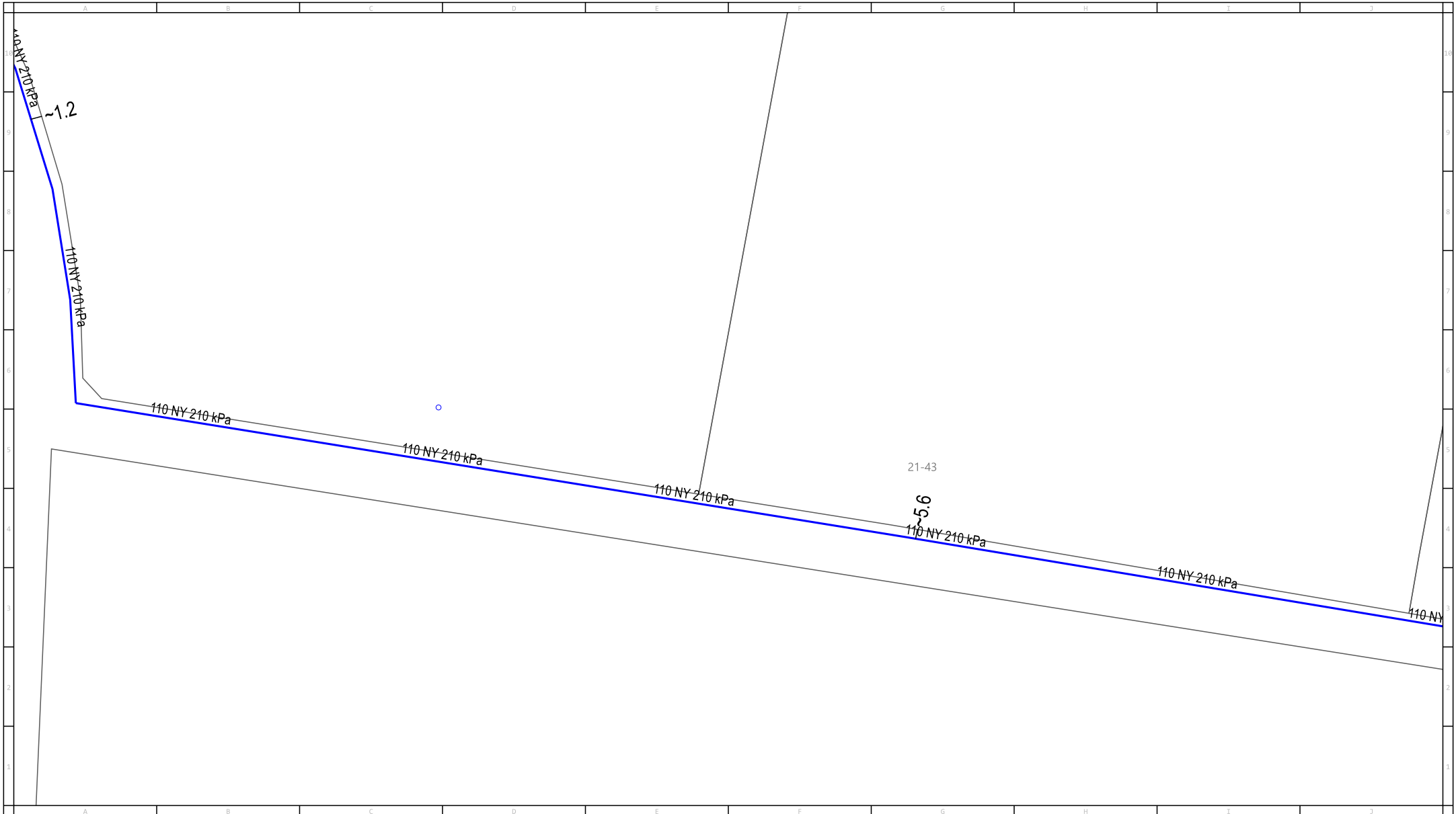

For legend details, please refer to the Coversheet attachment provided as part of this DBYD response.

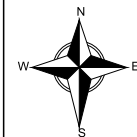

Scale: 1:2000

Issue Date: 07/01/2021

DBYD Seq No: 105303053

DBYD Job No: 20857103

0m 10m 20m 30m 40m 50m 60m 70m 80m



WARNING: This is a representation of Jemena Gas Networks underground assets only and may not indicate all assets in the area. It must not be used for the purpose of exact asset location in order to undertake any type of excavation. This plan is diagrammatic only, and distances scaled from this plan may not be accurate. Please read all conditions and information on the attached information sheet. This extract is subject to those conditions. The information contained on this plan is only valid for 28 days from the date of issue.

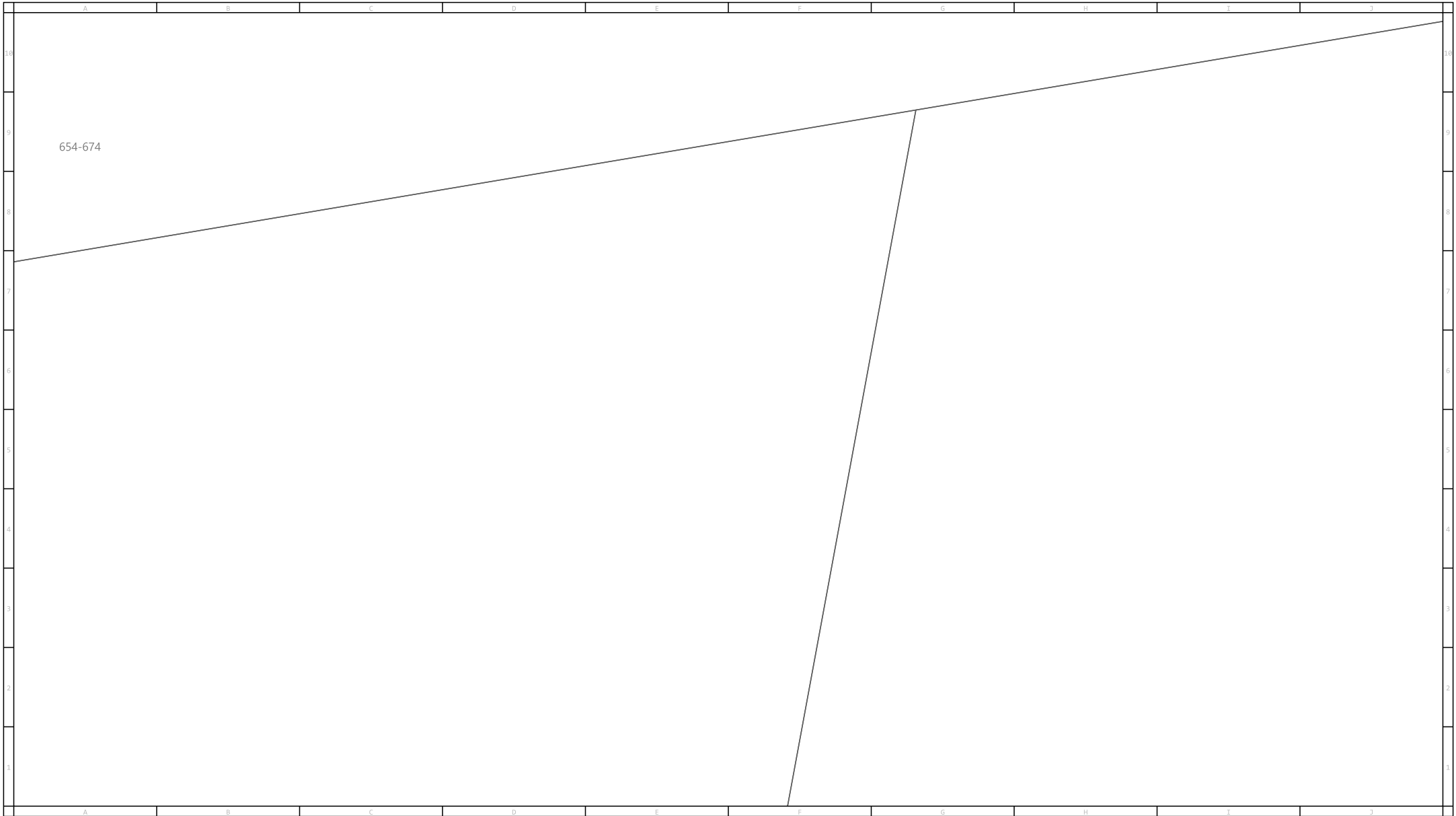

For legend details, please refer to the Coversheet attachment provided as part of this DBYD response.

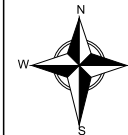

Scale: 1:2000

Issue Date: 07/01/2021

DBYD Seq No: 105303053

DBYD Job No: 20857103

0m 10m 20m 30m 40m 50m 60m 70m 80m



WARNING: This is a representation of Jemena Gas Networks underground assets only and may not indicate all assets in the area. It must not be used for the purpose of exact asset location in order to undertake any type of excavation. This plan is diagrammatic only, and distances scaled from this plan may not be accurate. Please read all conditions and information on the attached information sheet. This extract is subject to those conditions. The information contained on this plan is only valid for 28 days from the date of issue.











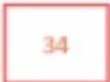

Indicative Plans

Issue Date:	07/01/2021	
Location:	Mamre Road , Kemps Creek , NSW , 2178	

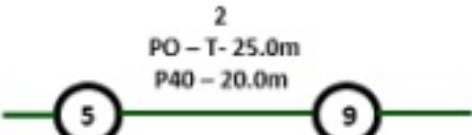
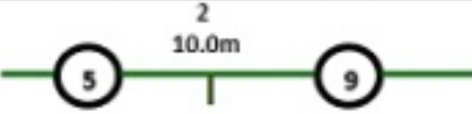
2	10	18	26	34	42
3	11	19	27	35	43
4	12	20	28	36	44
5	13	21	29	37	45
6	14	22	30	38	46
7	15	23	31	39	47
8	16	24	32	40	48



LEGEND

	Parcel and the location
	Pit with size "5"
	Power Pit with size "2E". Valid PIT Size: e.g. 2E, 5E, 6E, 8E, 9E, E, null.
	Manhole
	Pillar
	Cable count of trench is 2. One "Other size" PVC conduit (PO) owned by Telstra (-T-), between pits of sizes, "5" and "9" are 25.0m apart. One 40mm PVC conduit (P40) owned by NBN, between pits of sizes, "5" and "9" are 20.0m apart.
	2 Direct buried cables between pits of sizes, "5" and "9" are 10.0m apart.
	Trench containing any INSERVICE/CONSTRUCTED (Copper/RF/Fibre) cables.
	Trench containing only DESIGNED/PLANNED (Copper/RF/Fibre/Power) cables.
	Trench containing any INSERVICE/CONSTRUCTED (Power) cables.
	Road and the street name "Broadway ST"
<p data-bbox="363 1865 443 1899">Scale</p>	<p data-bbox="683 1821 1139 1854">0 20 40 60 Meters</p> <p data-bbox="1098 1865 1187 1899">1:2000</p> <p data-bbox="1027 1899 1257 1933">1 cm equals 20 m</p> 



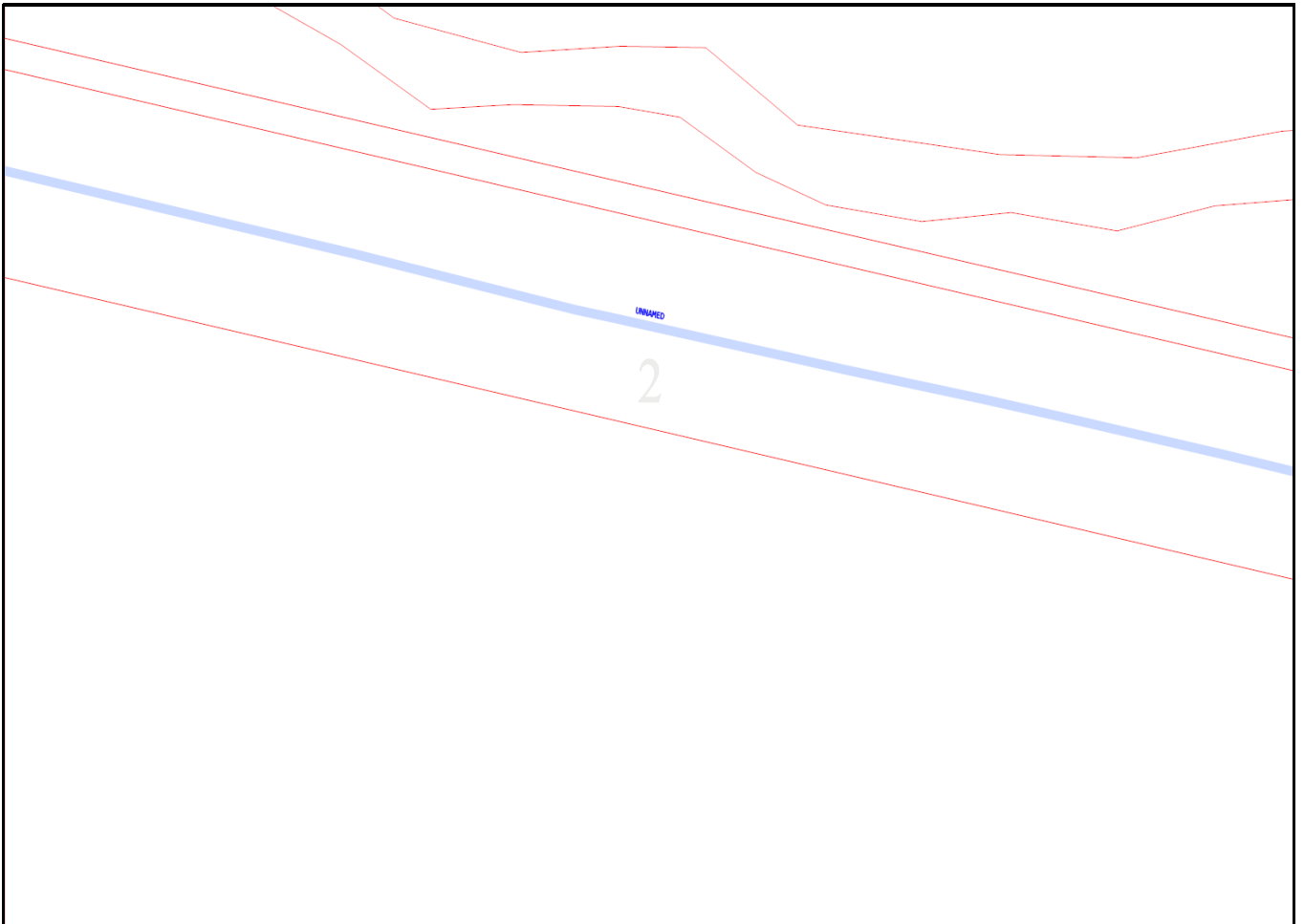



3

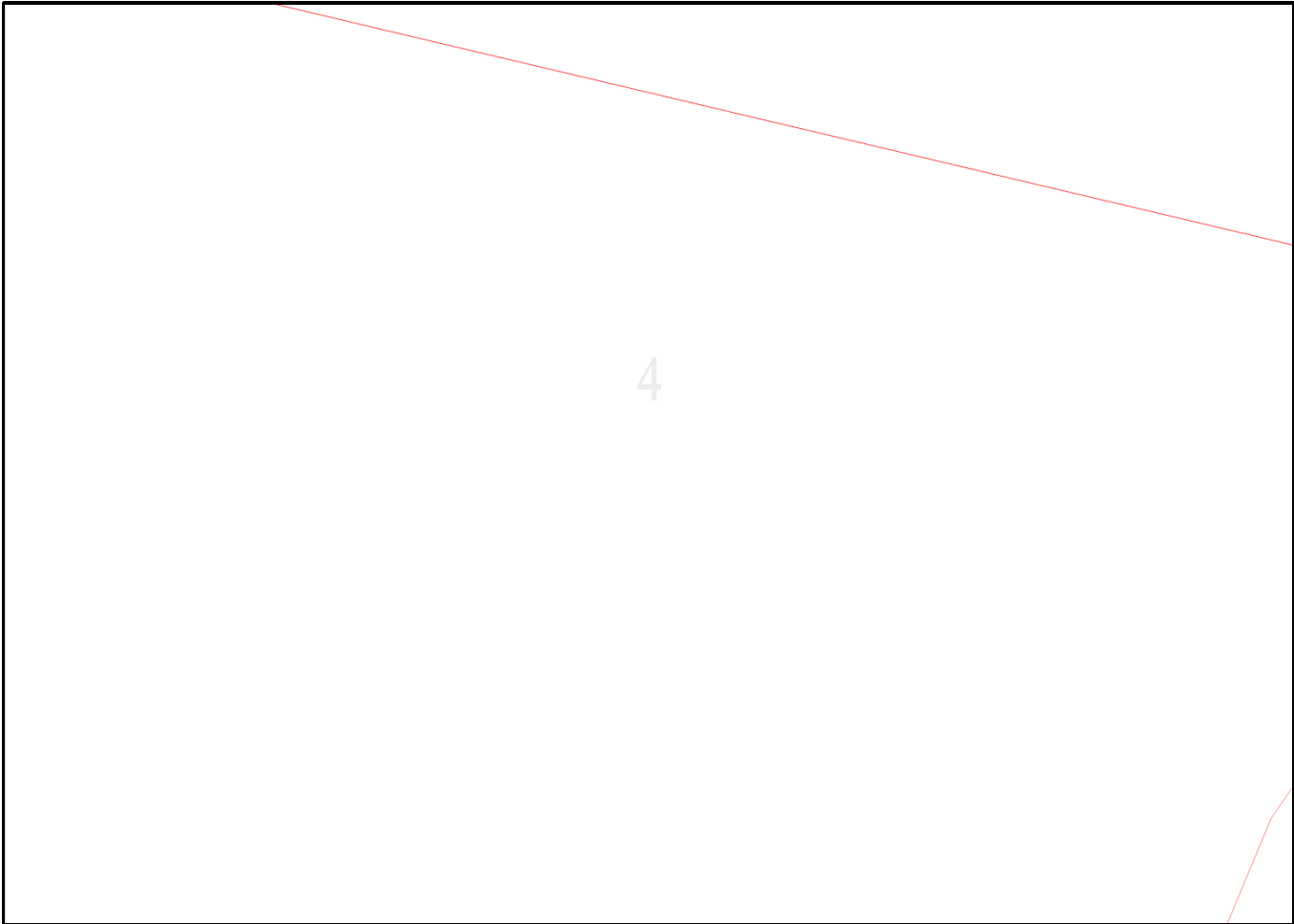



5

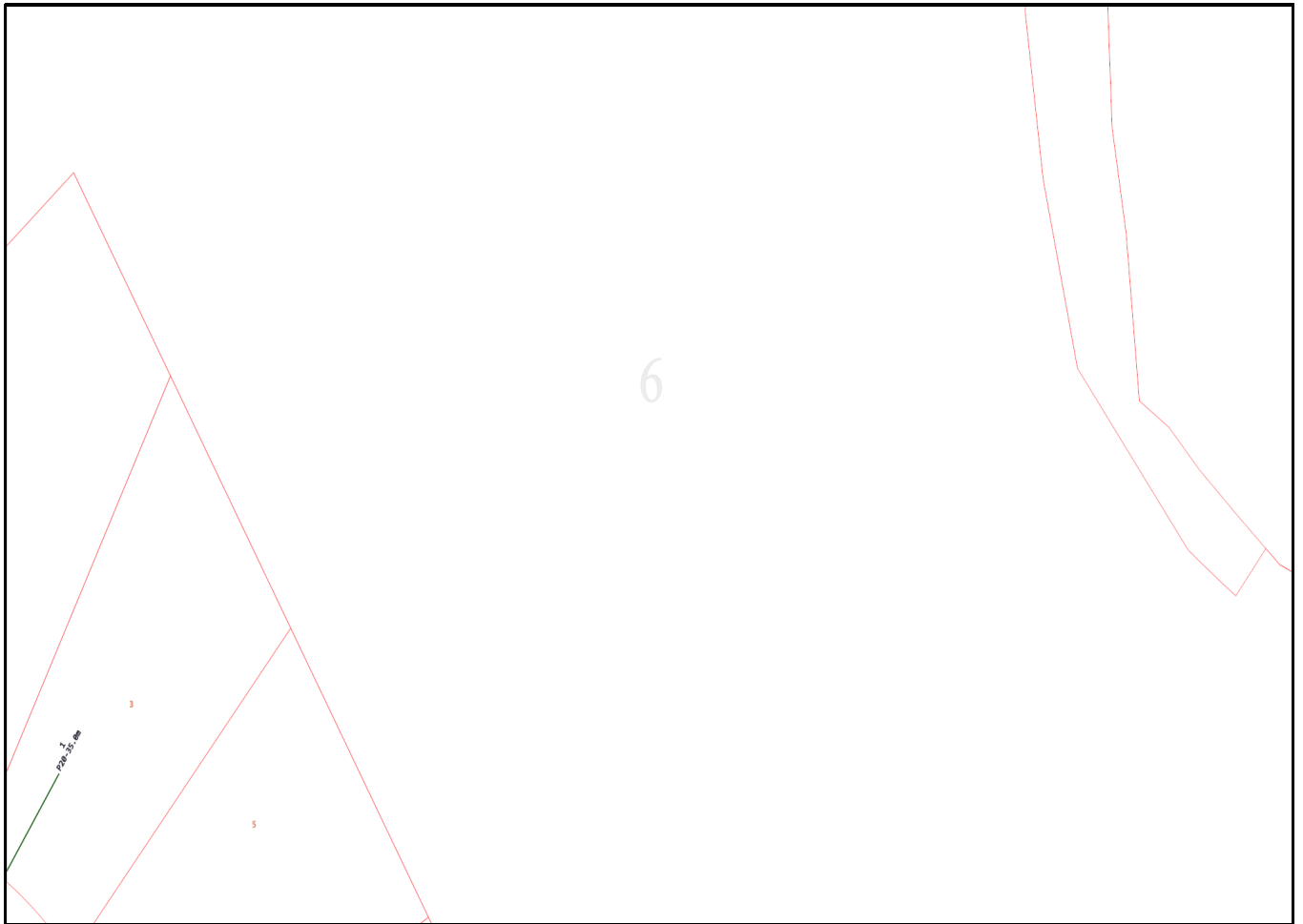

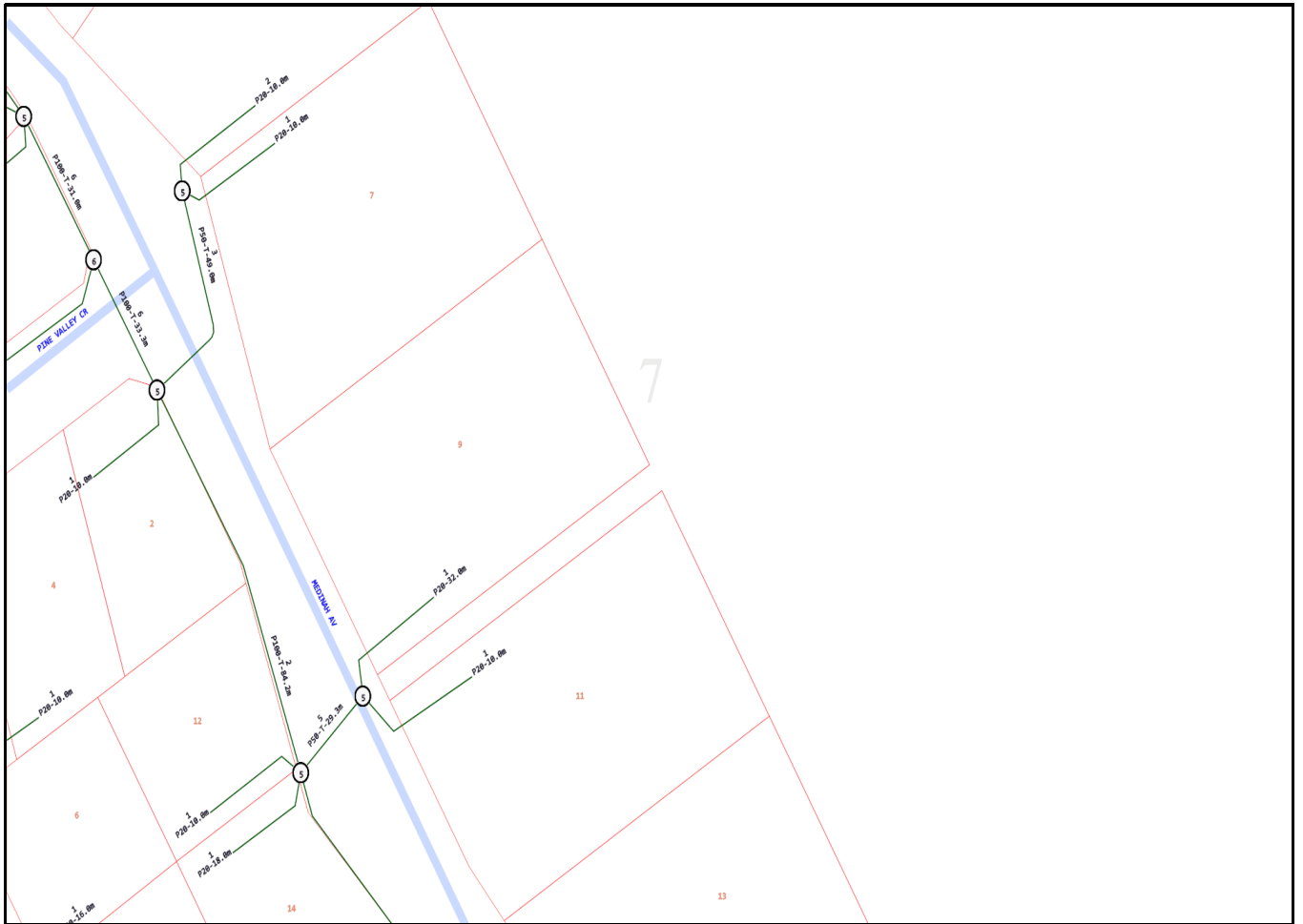

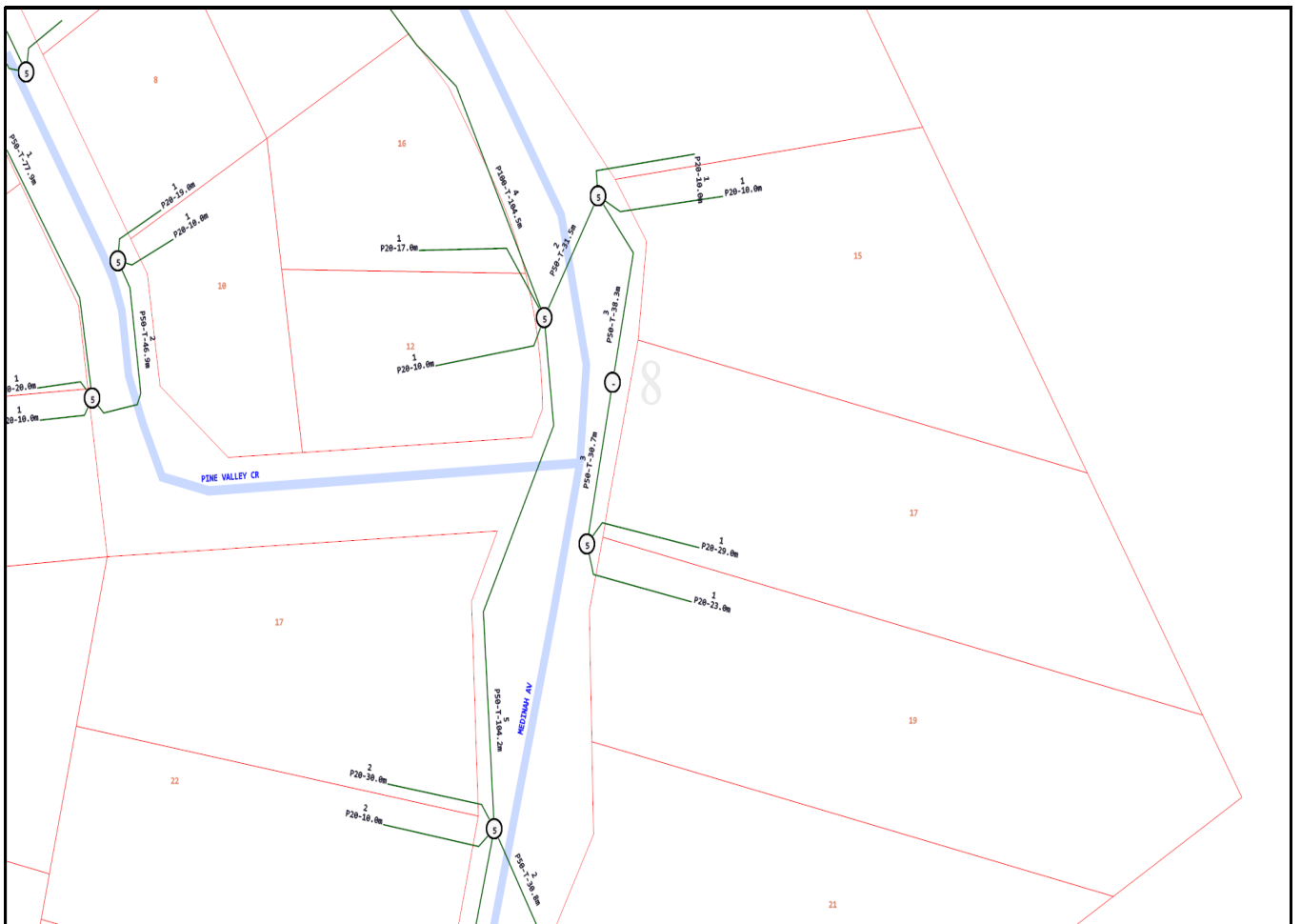

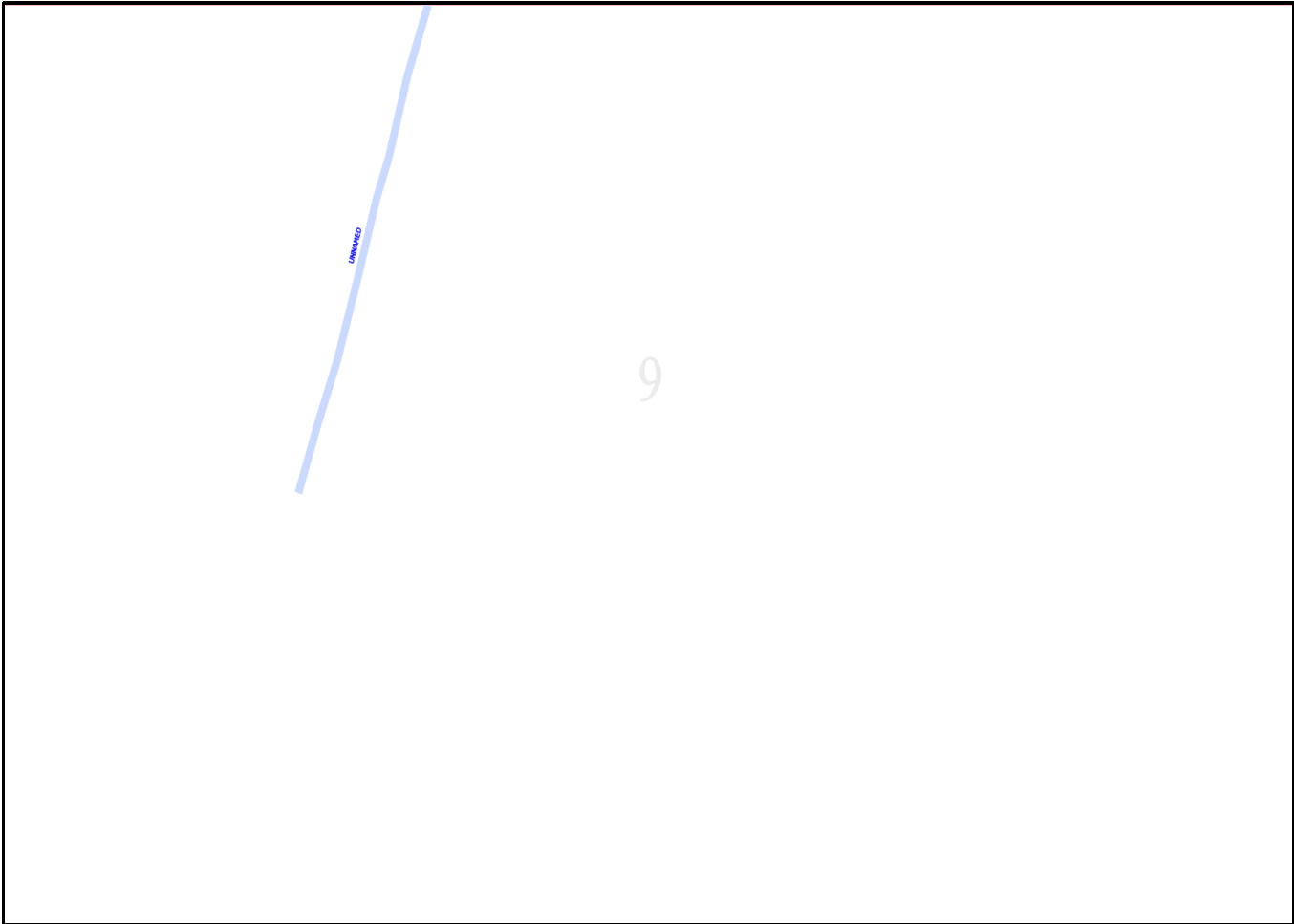

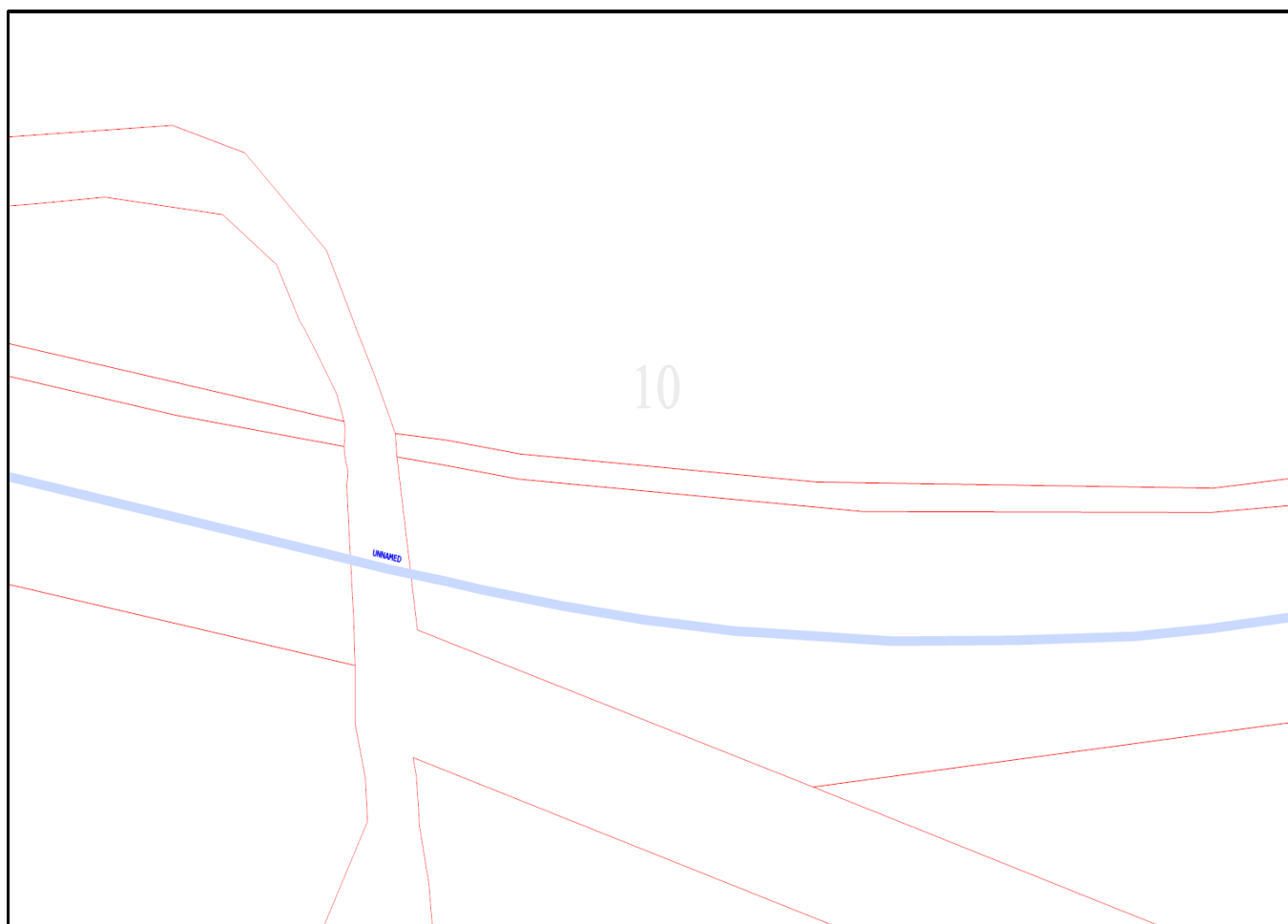

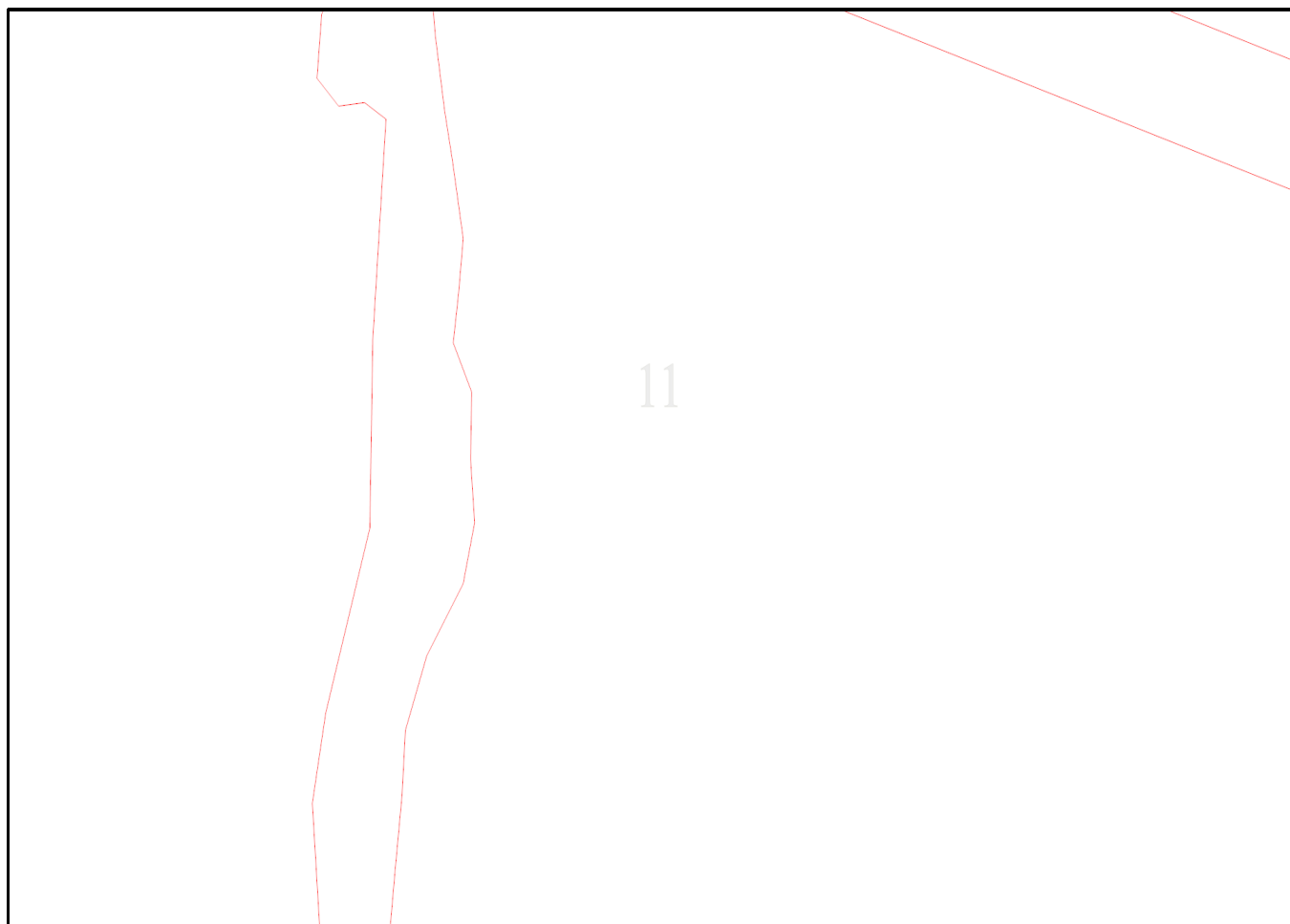





13

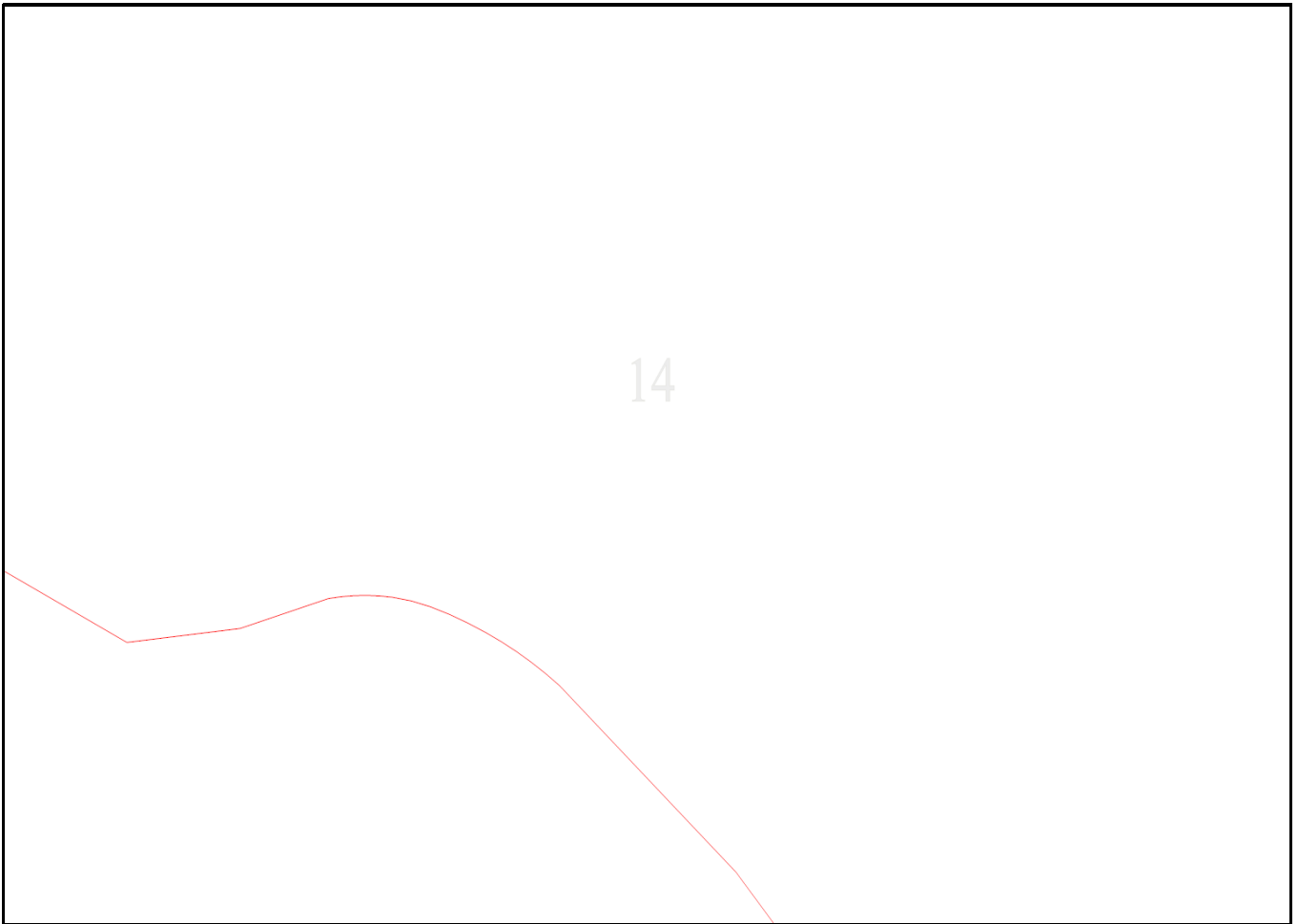

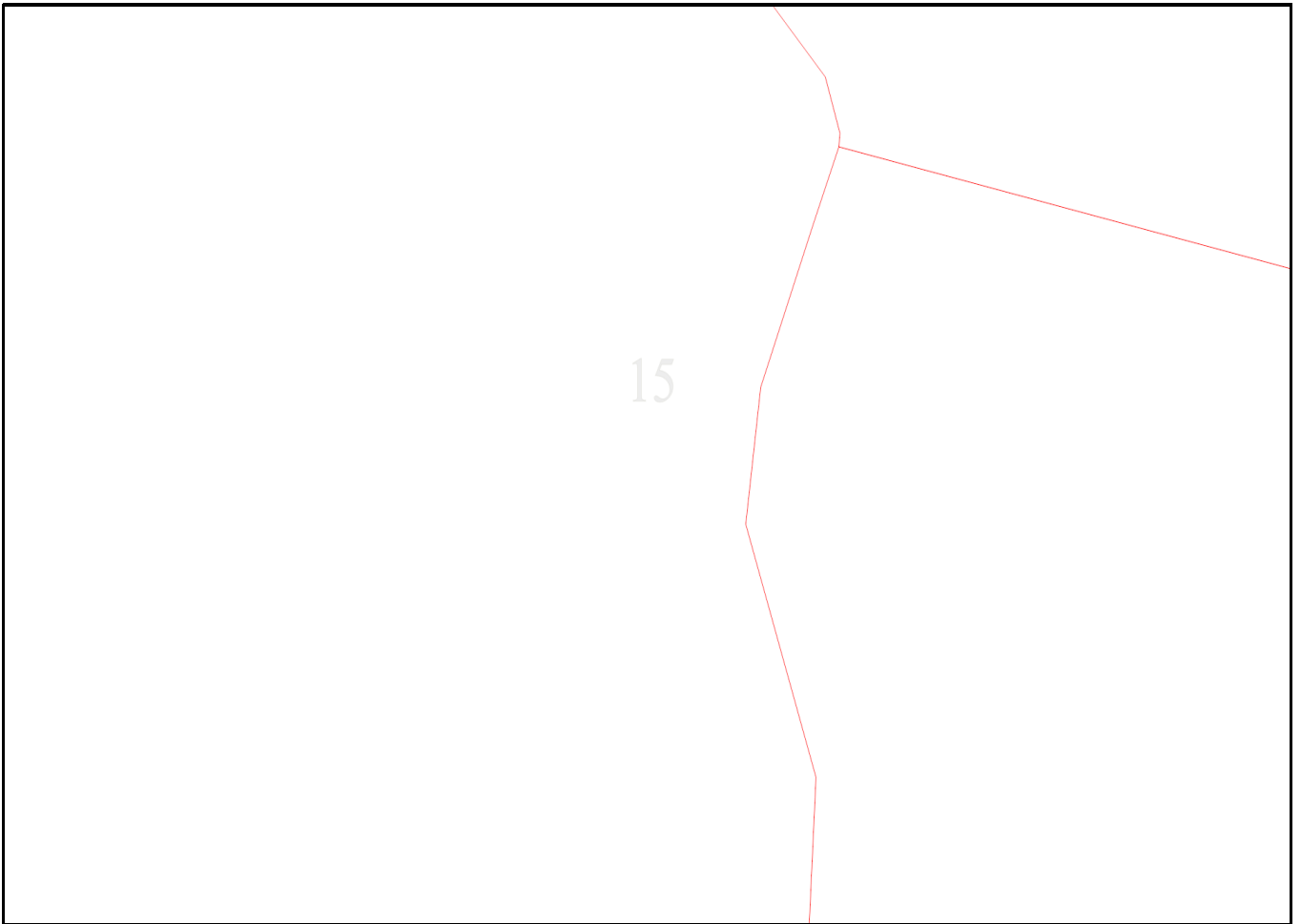



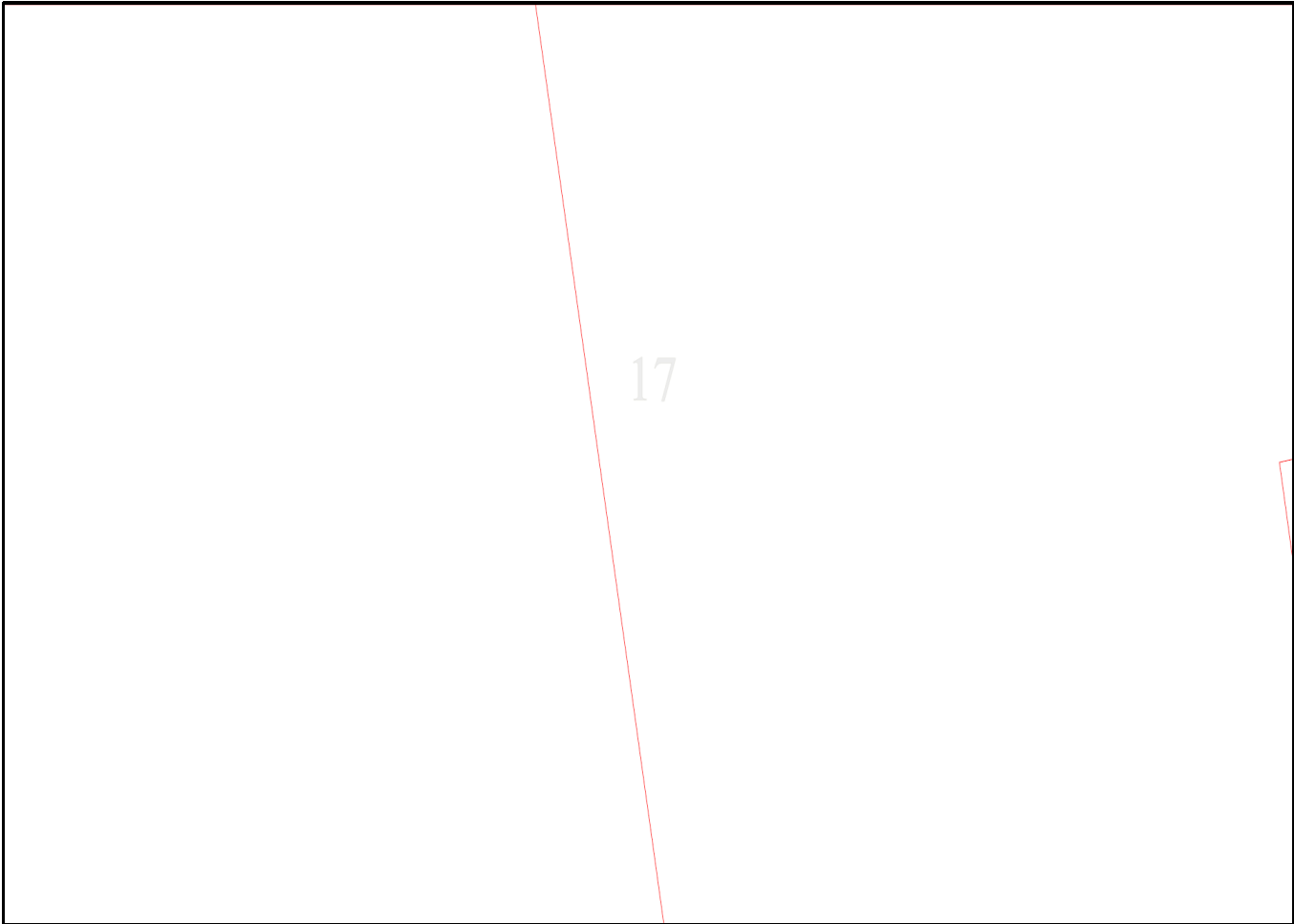

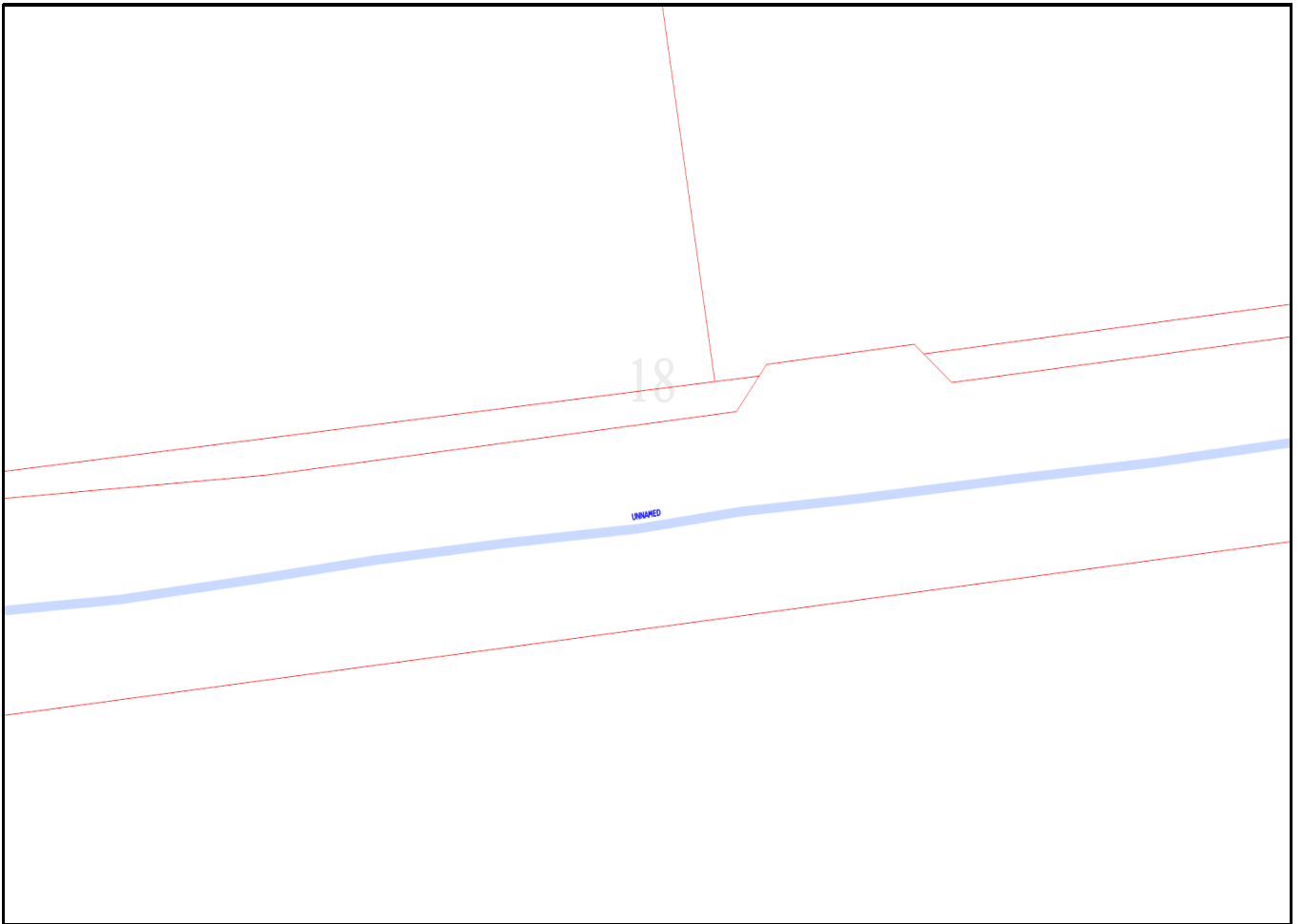

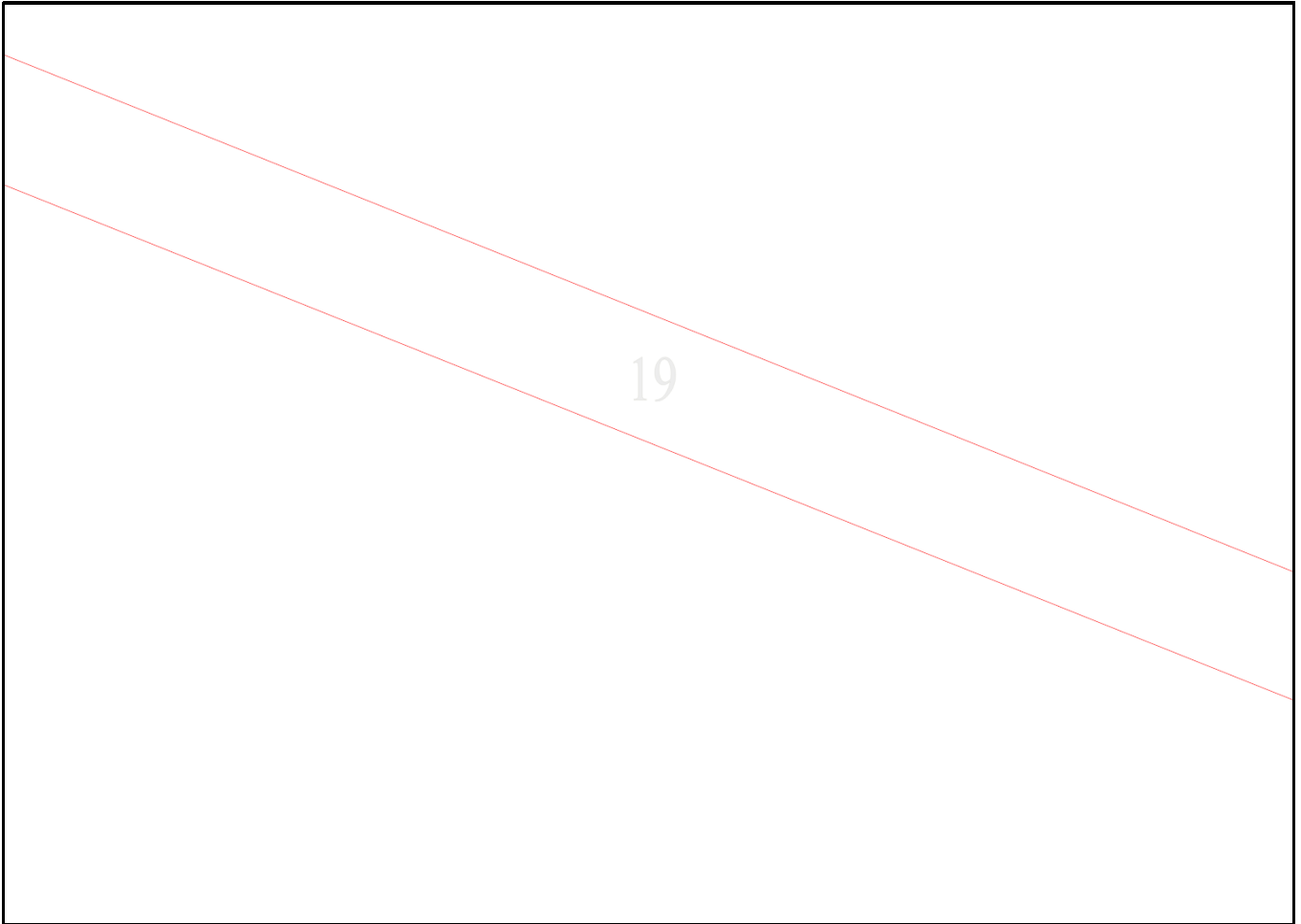



20

707A



21

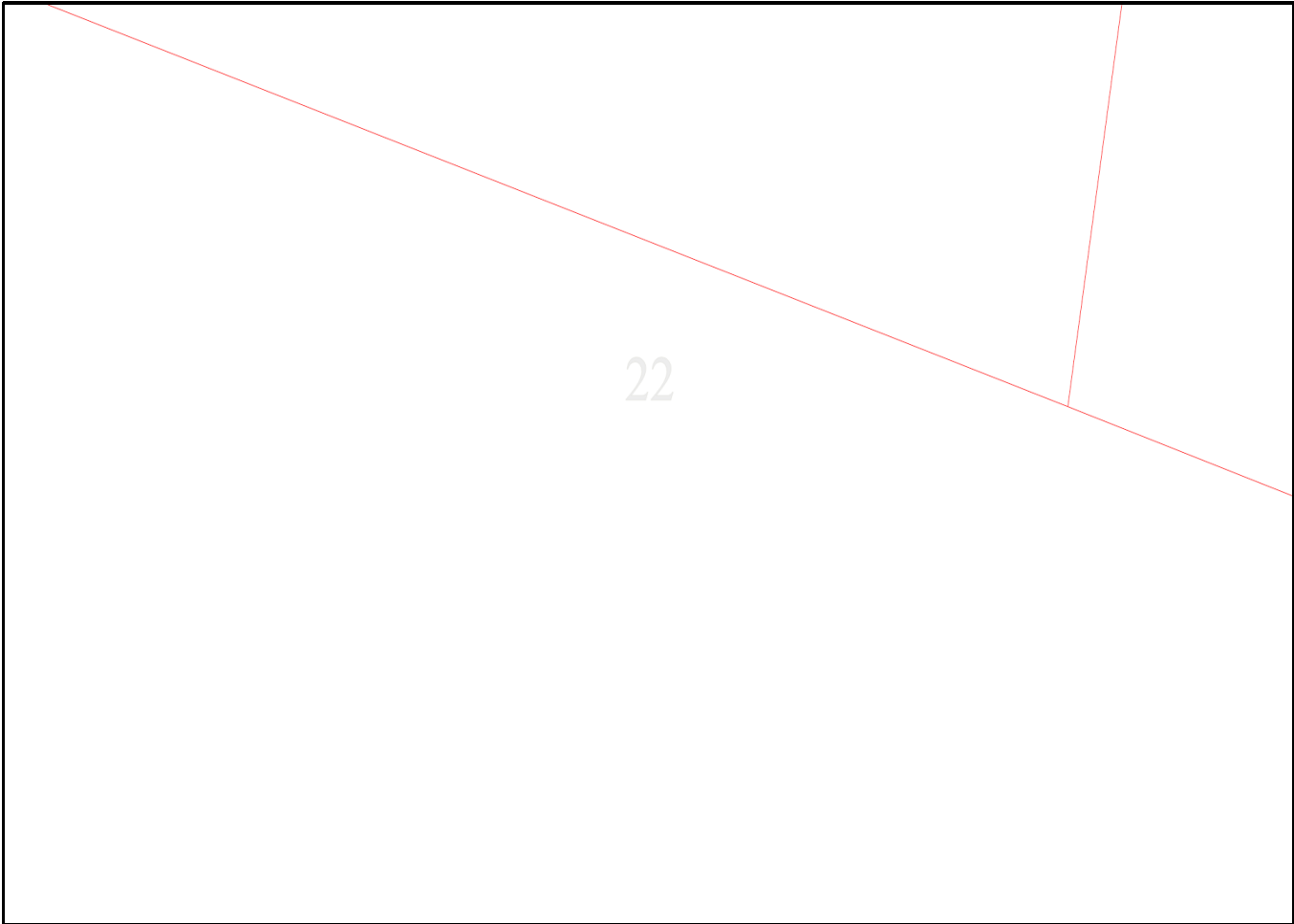

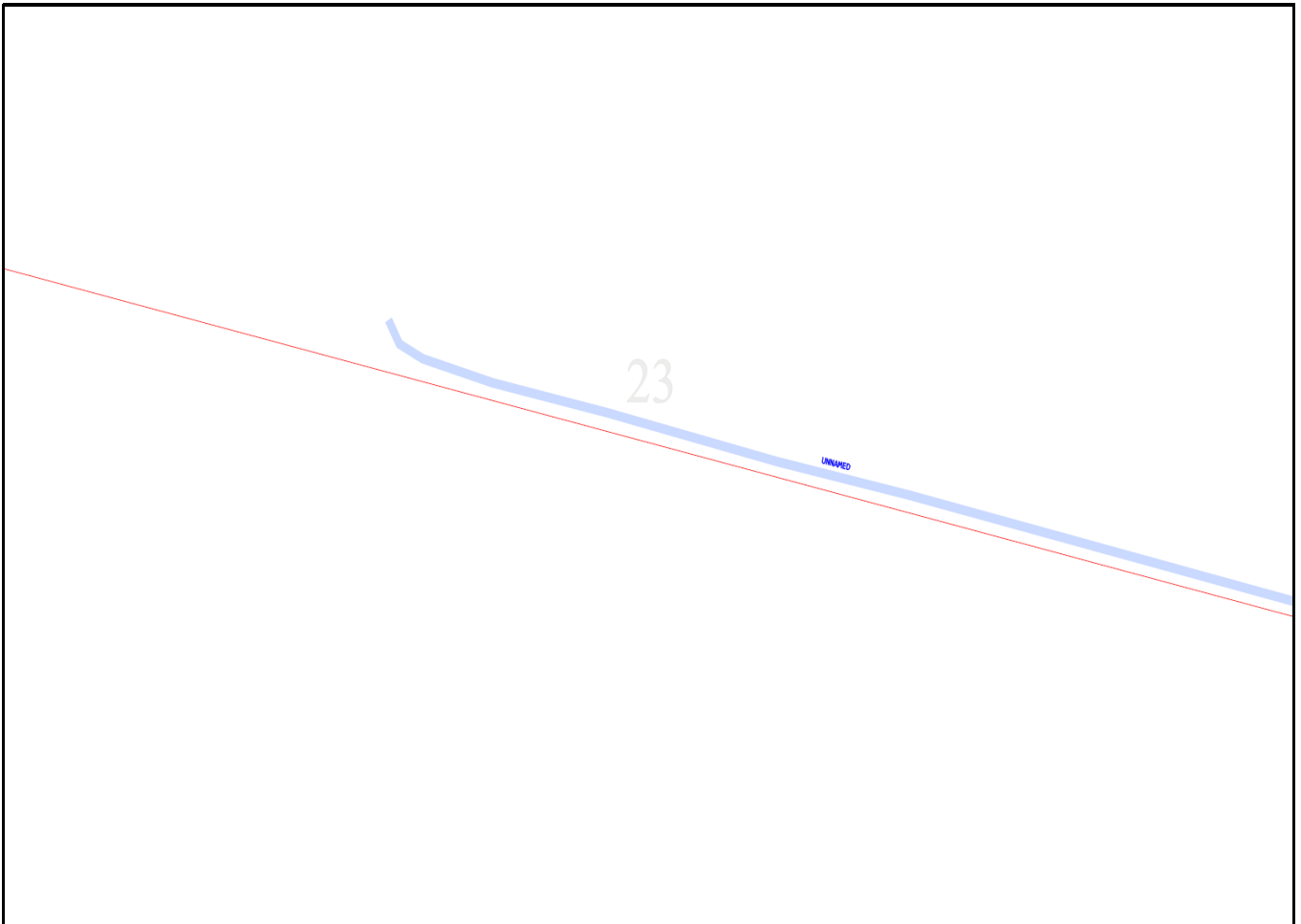

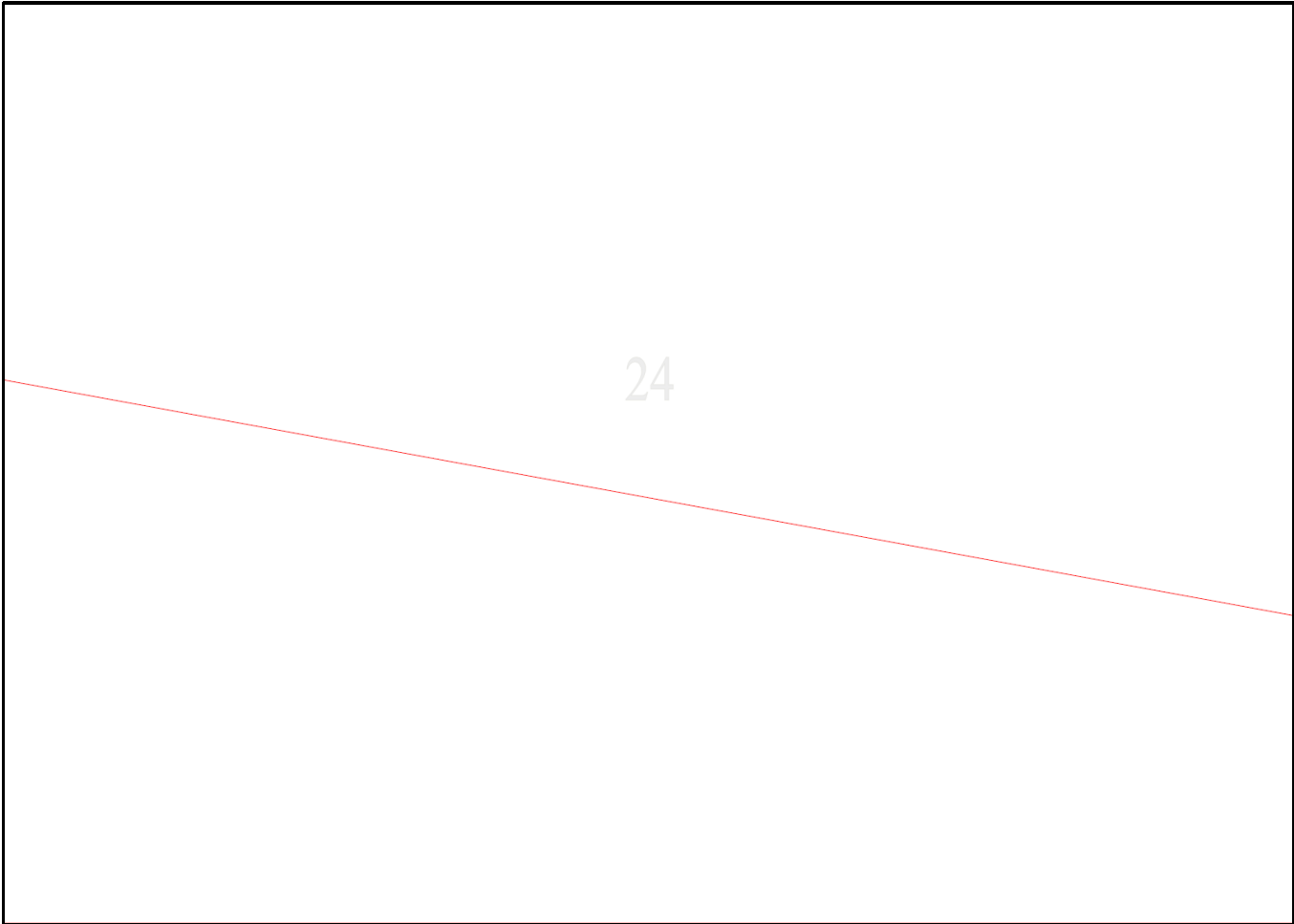

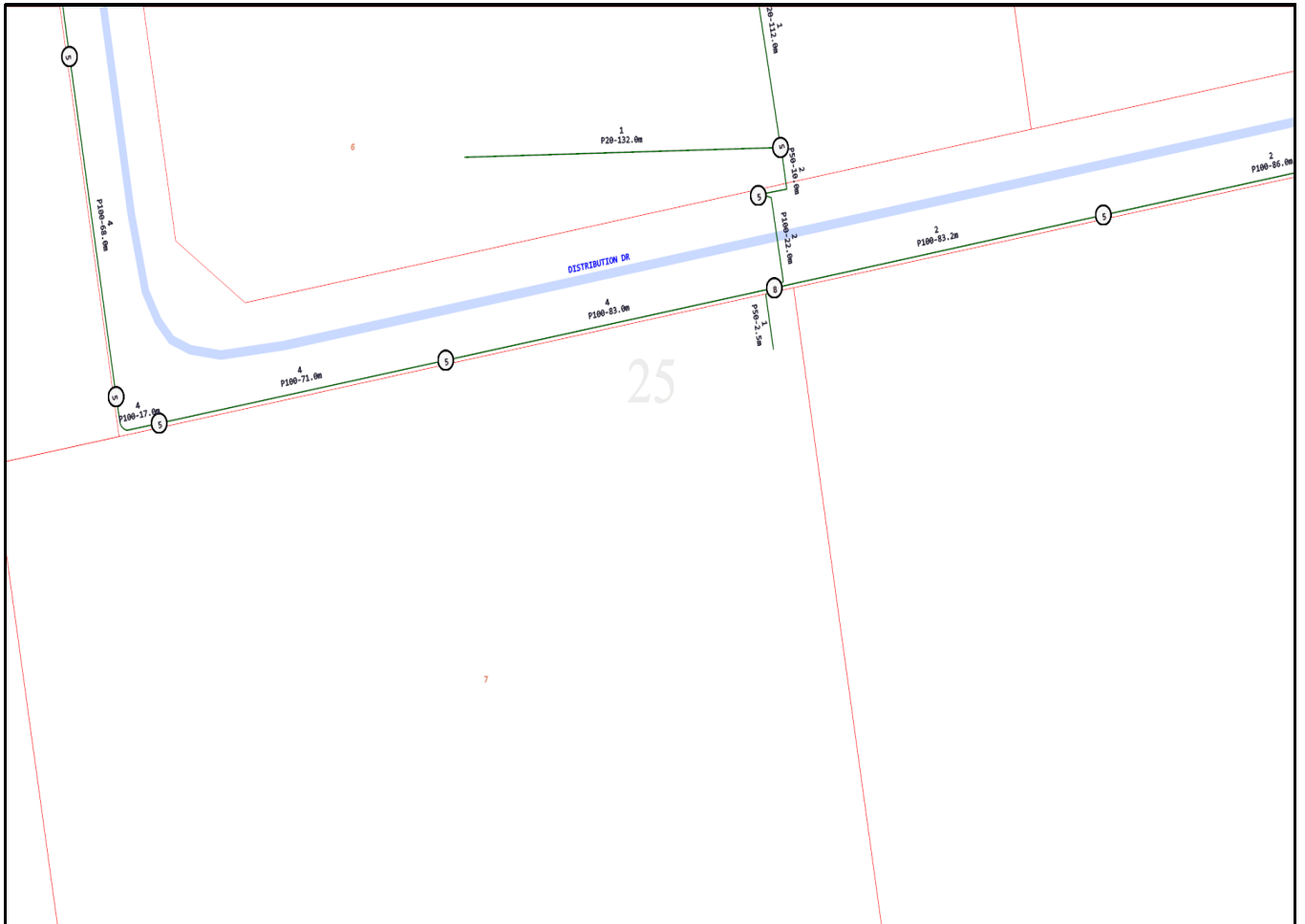

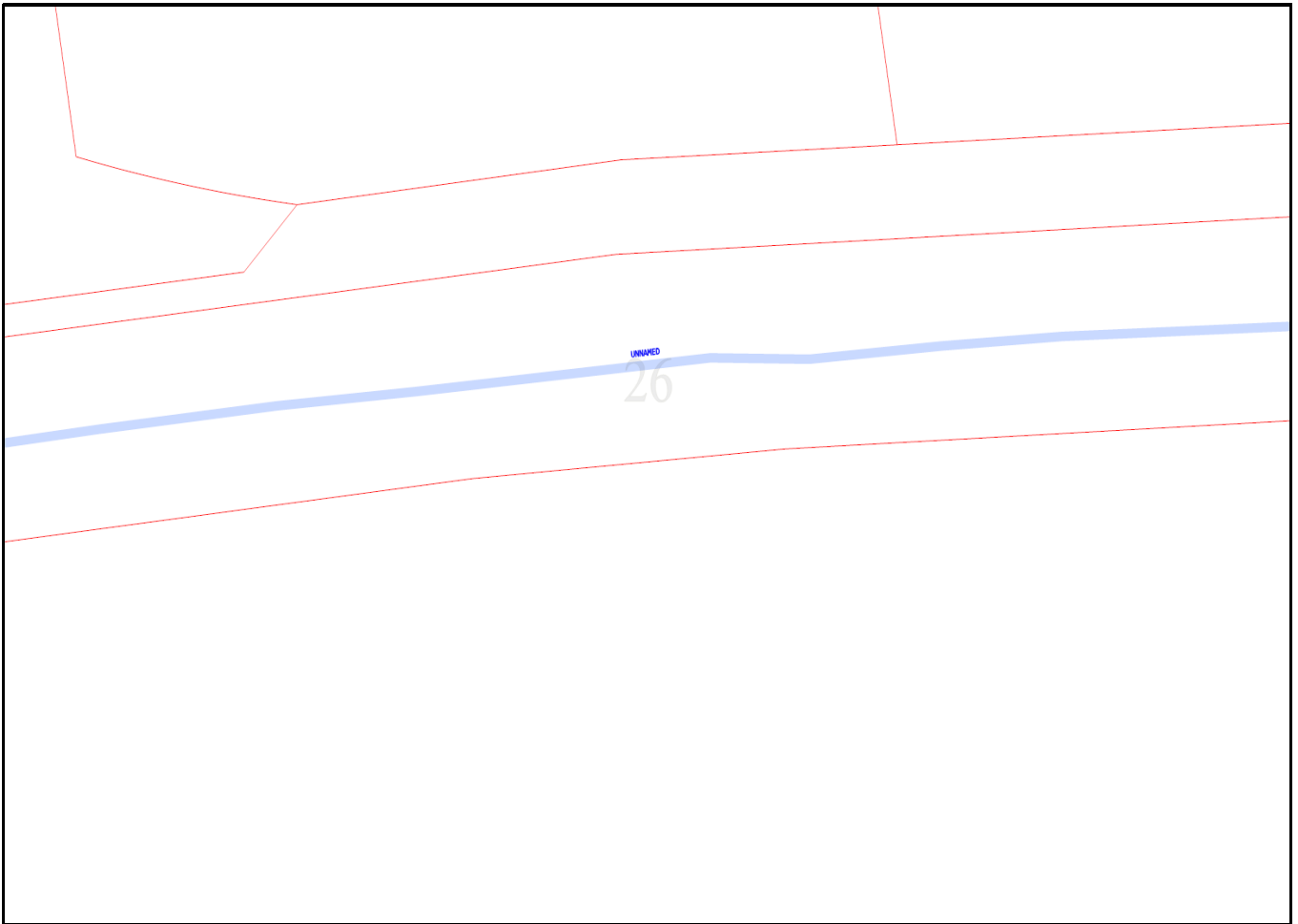



27

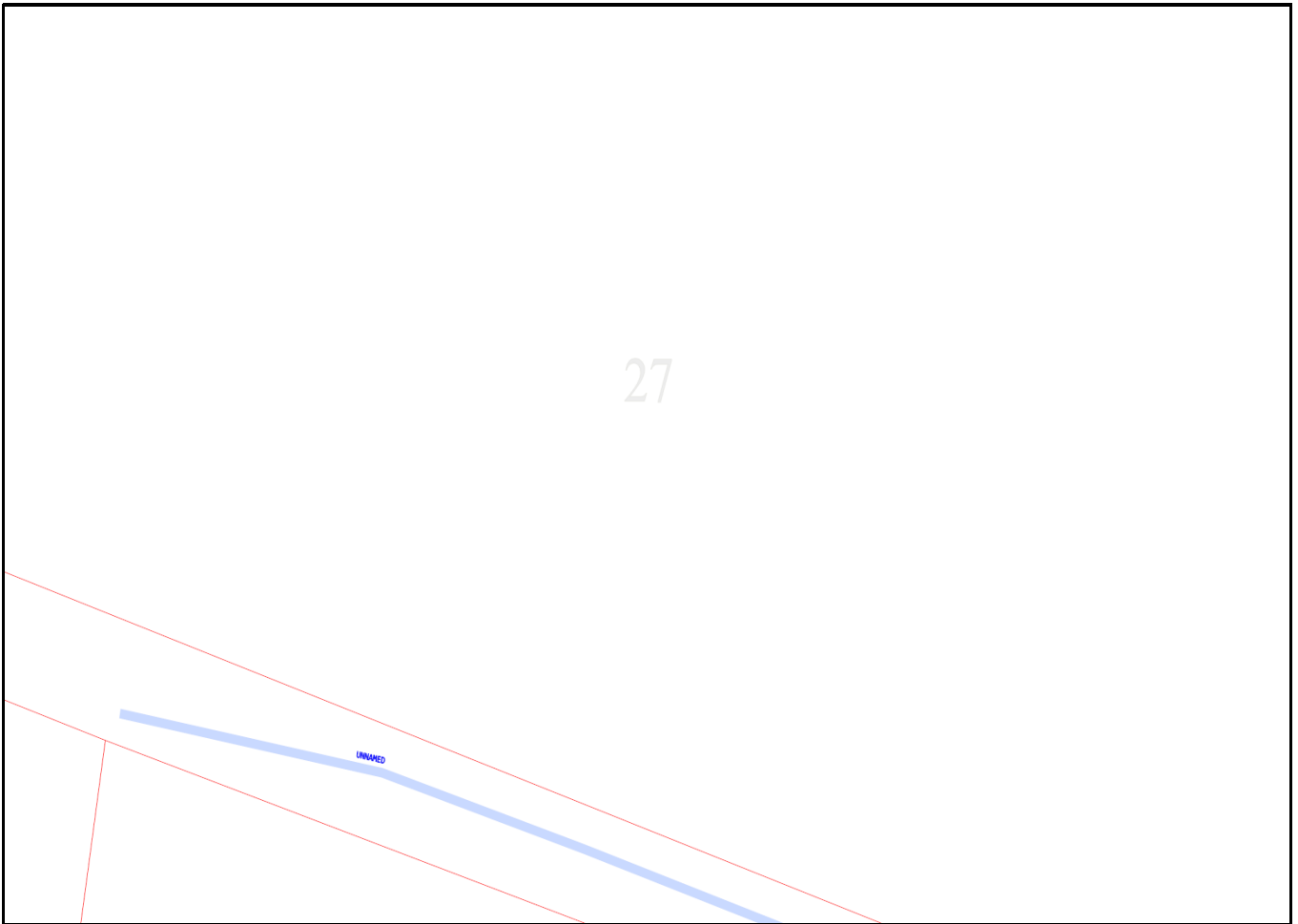

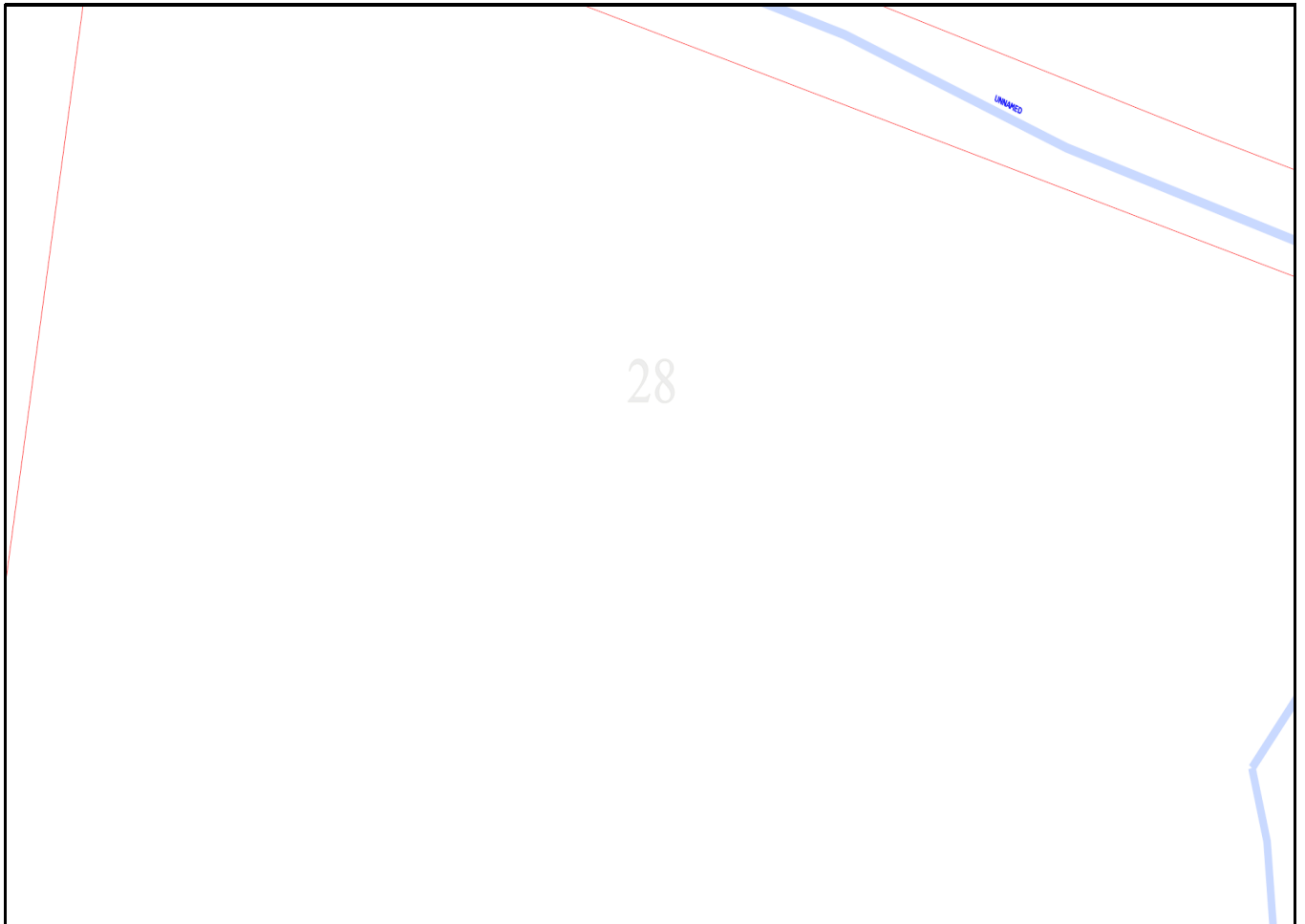



UNCLASSIFIED

29

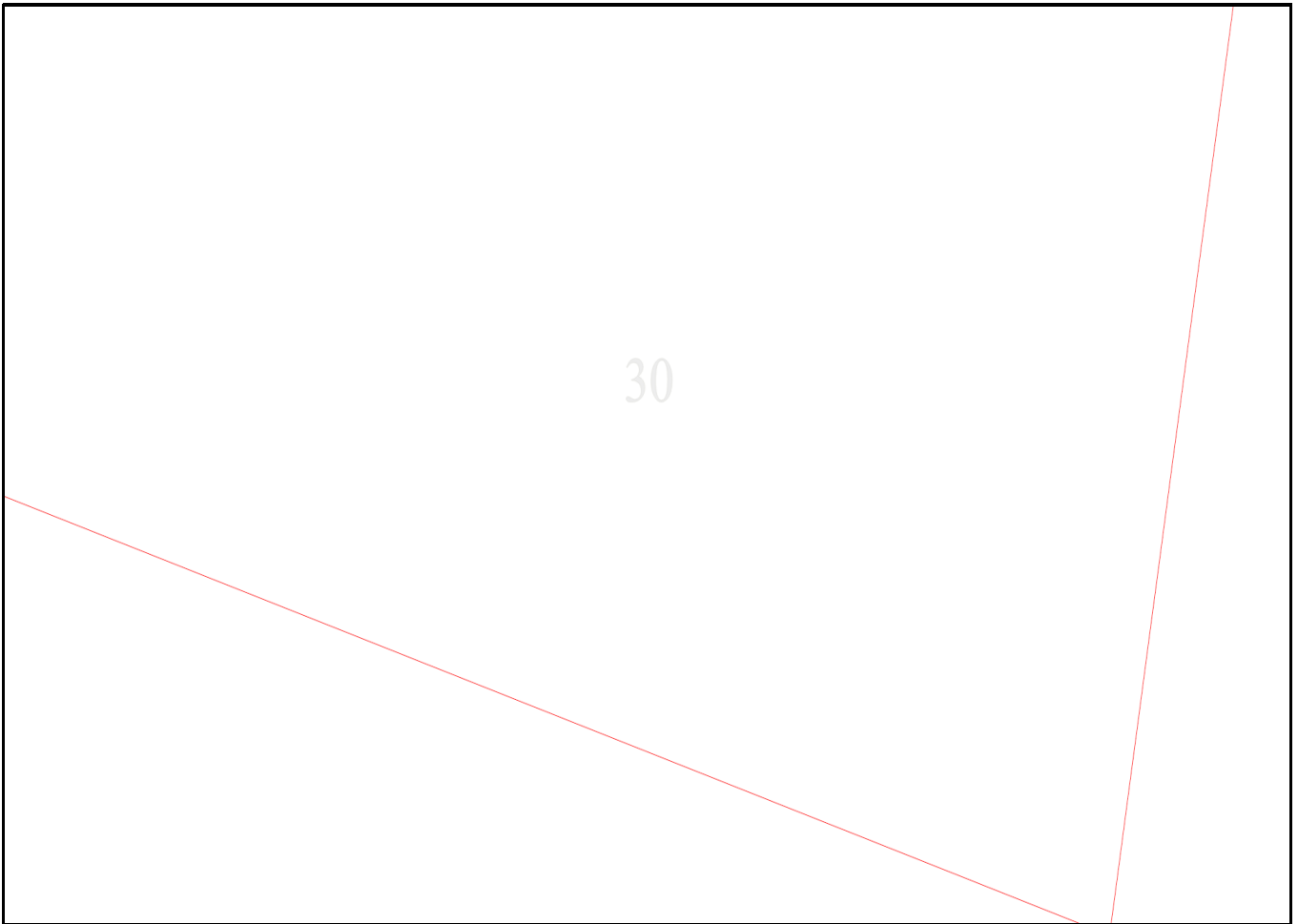



31

UNWIND



32

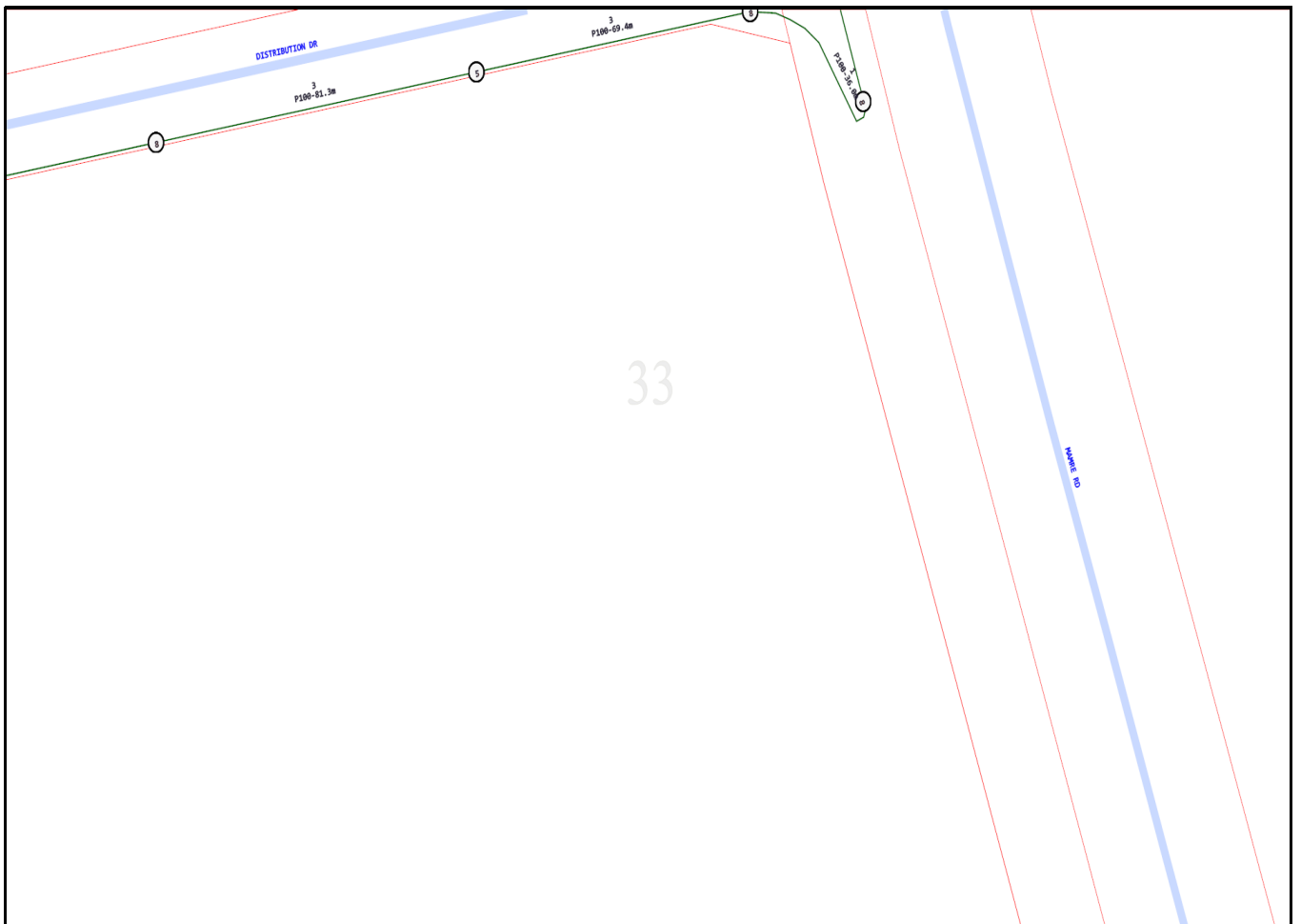

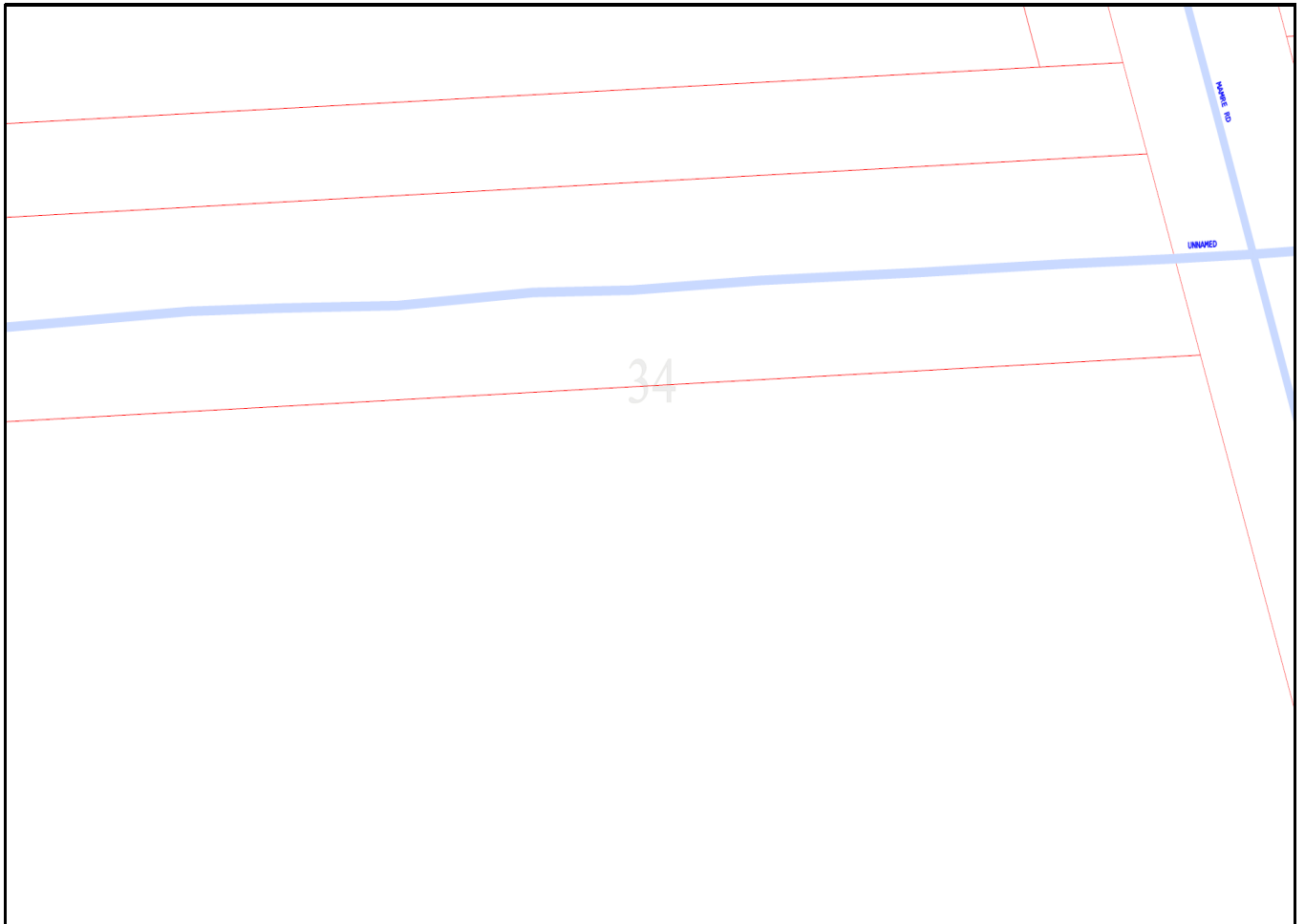



35

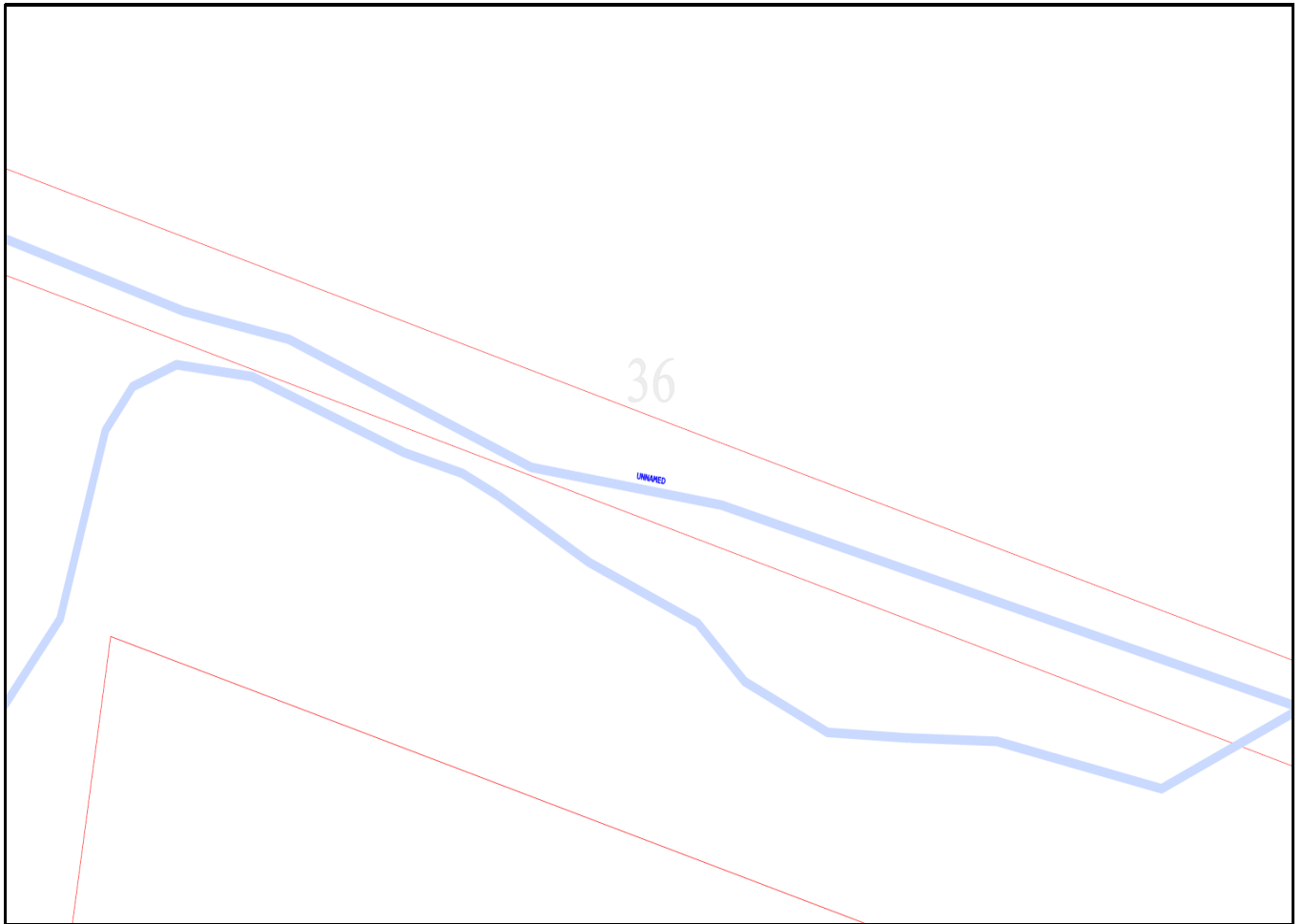



37



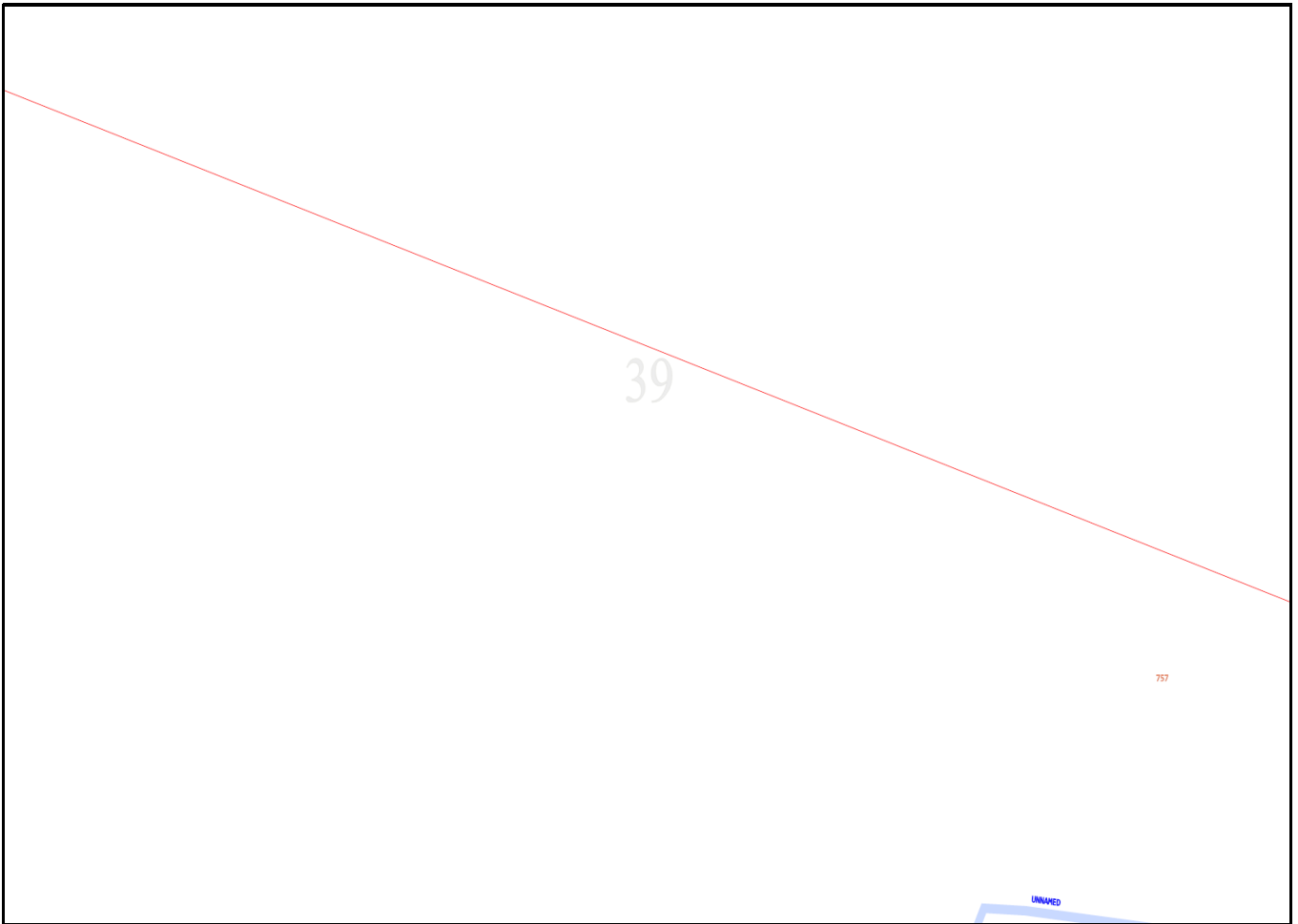

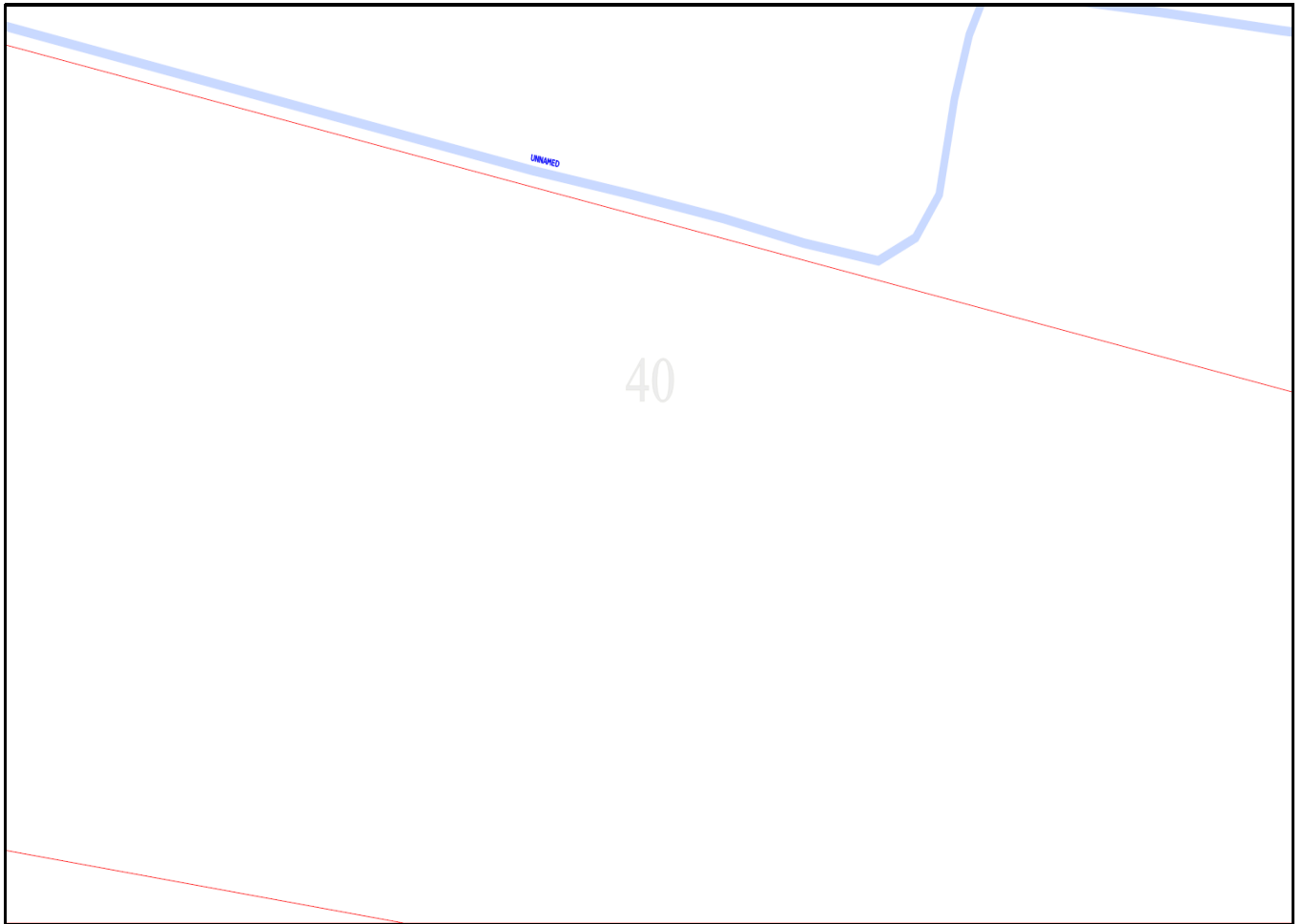



35-44

41

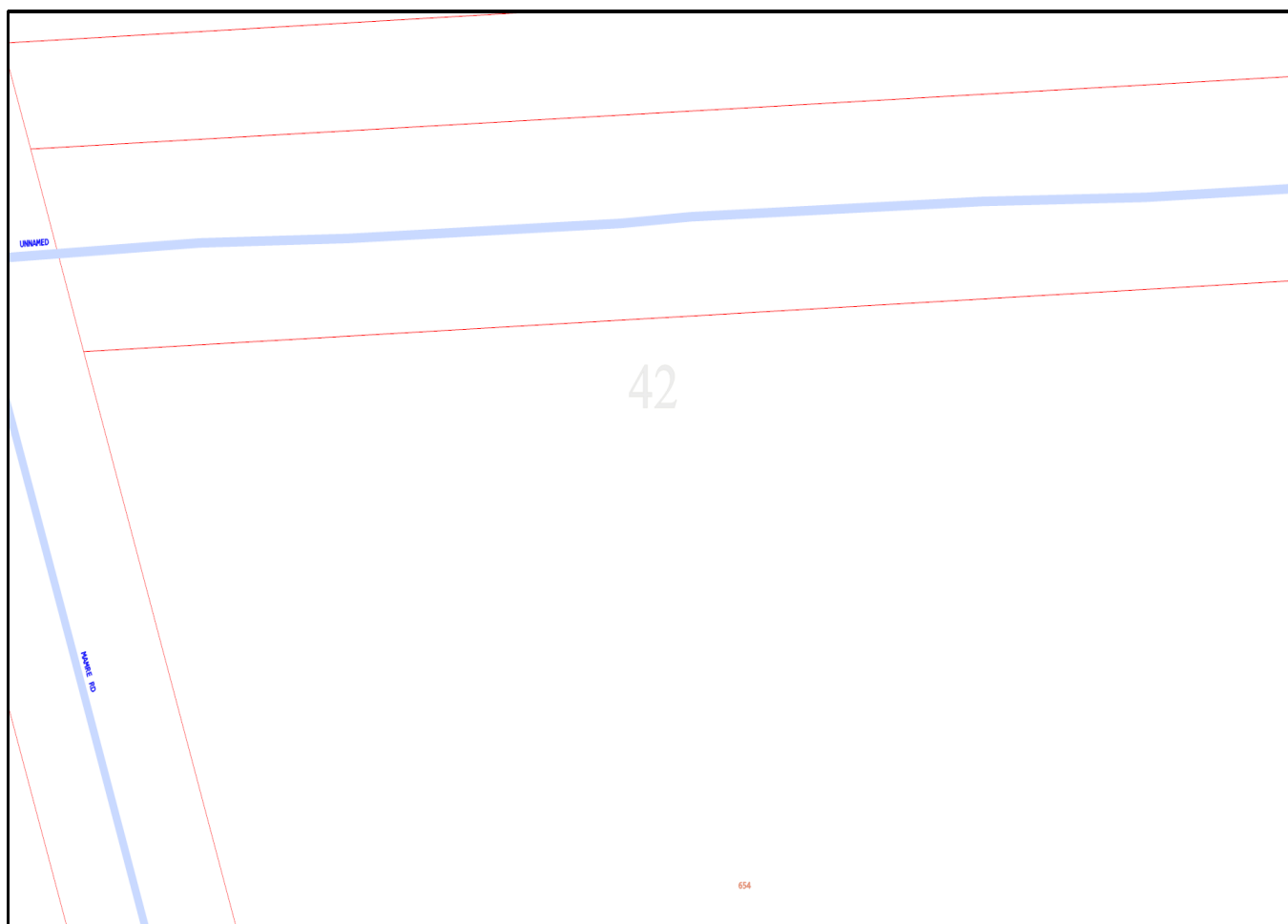

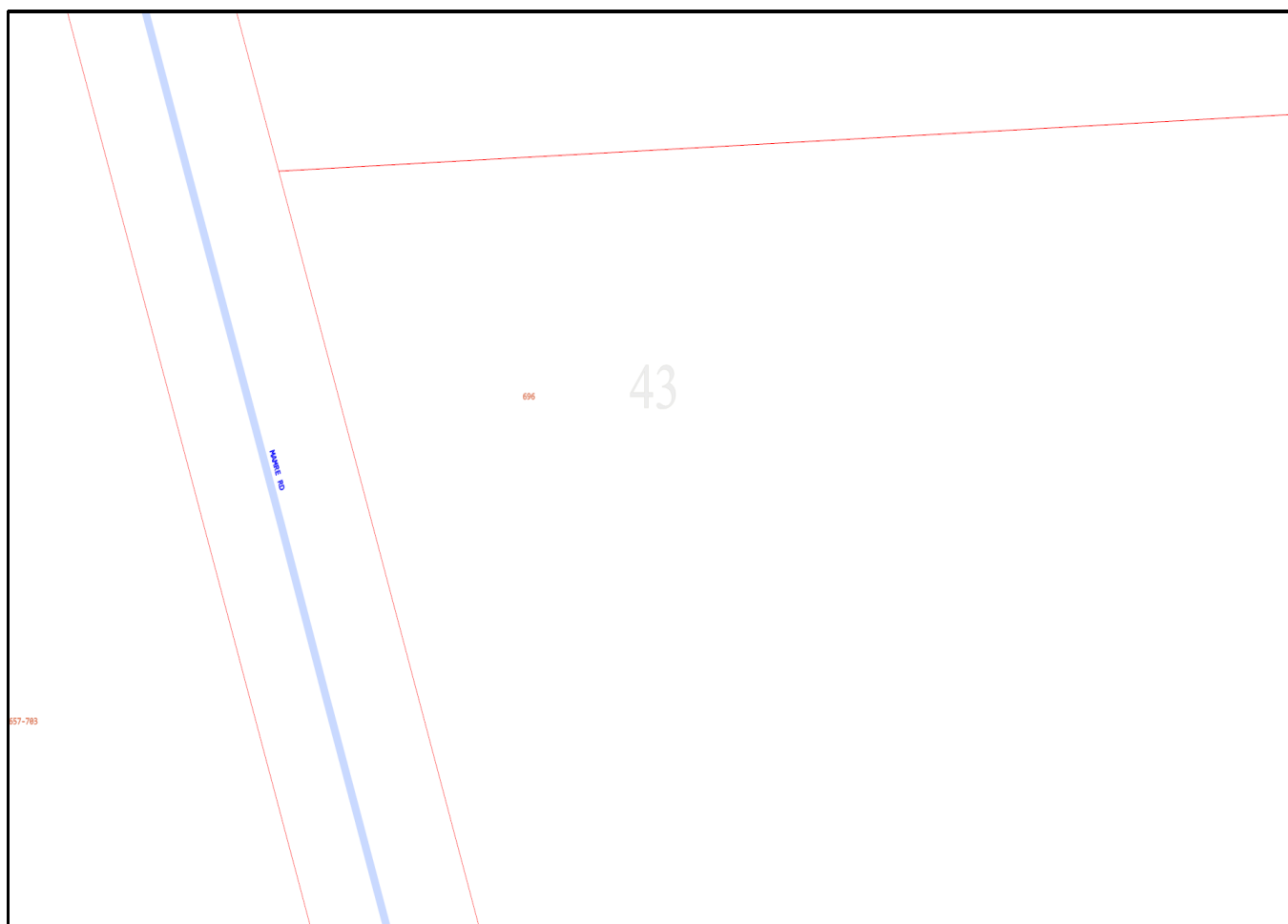

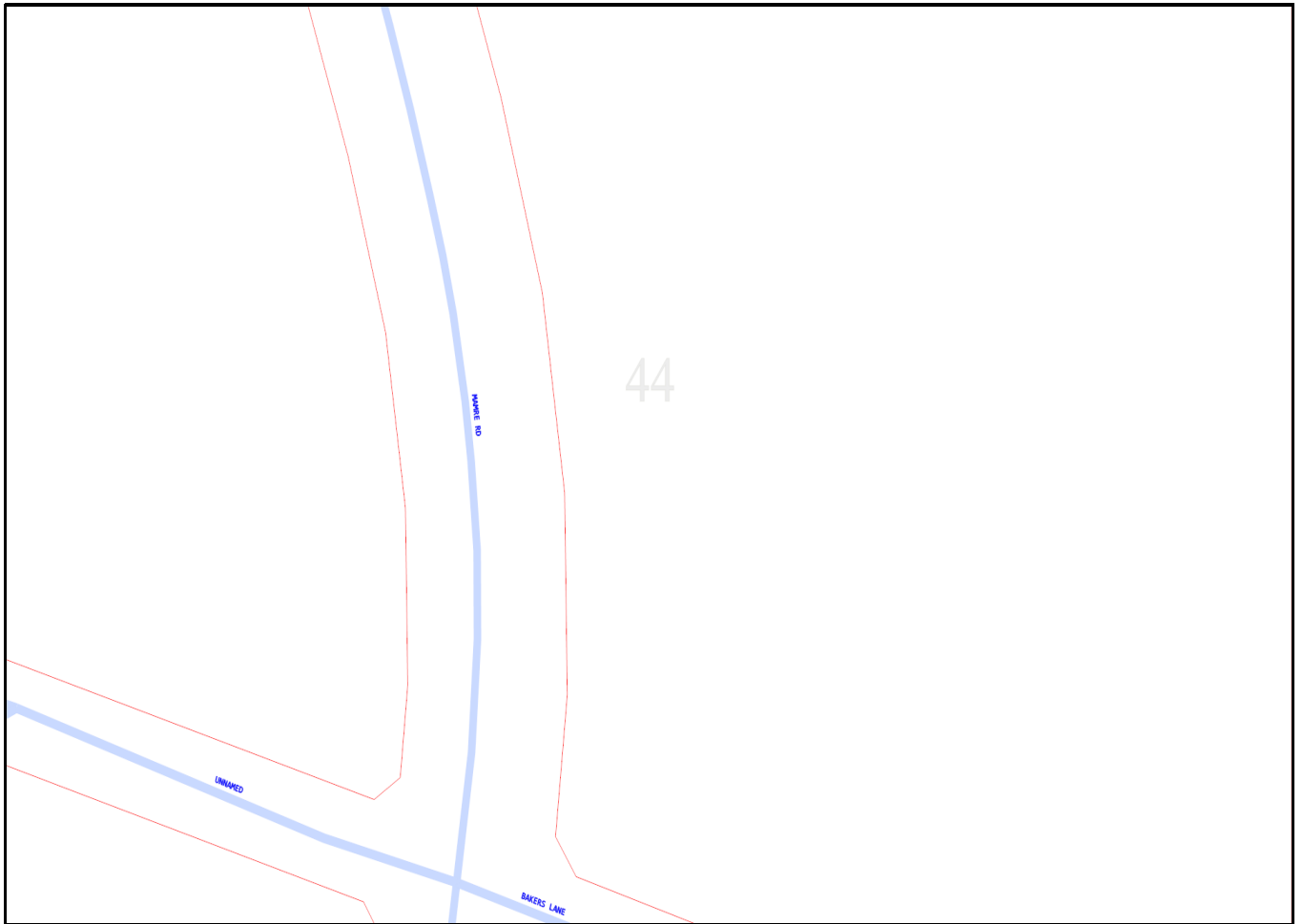

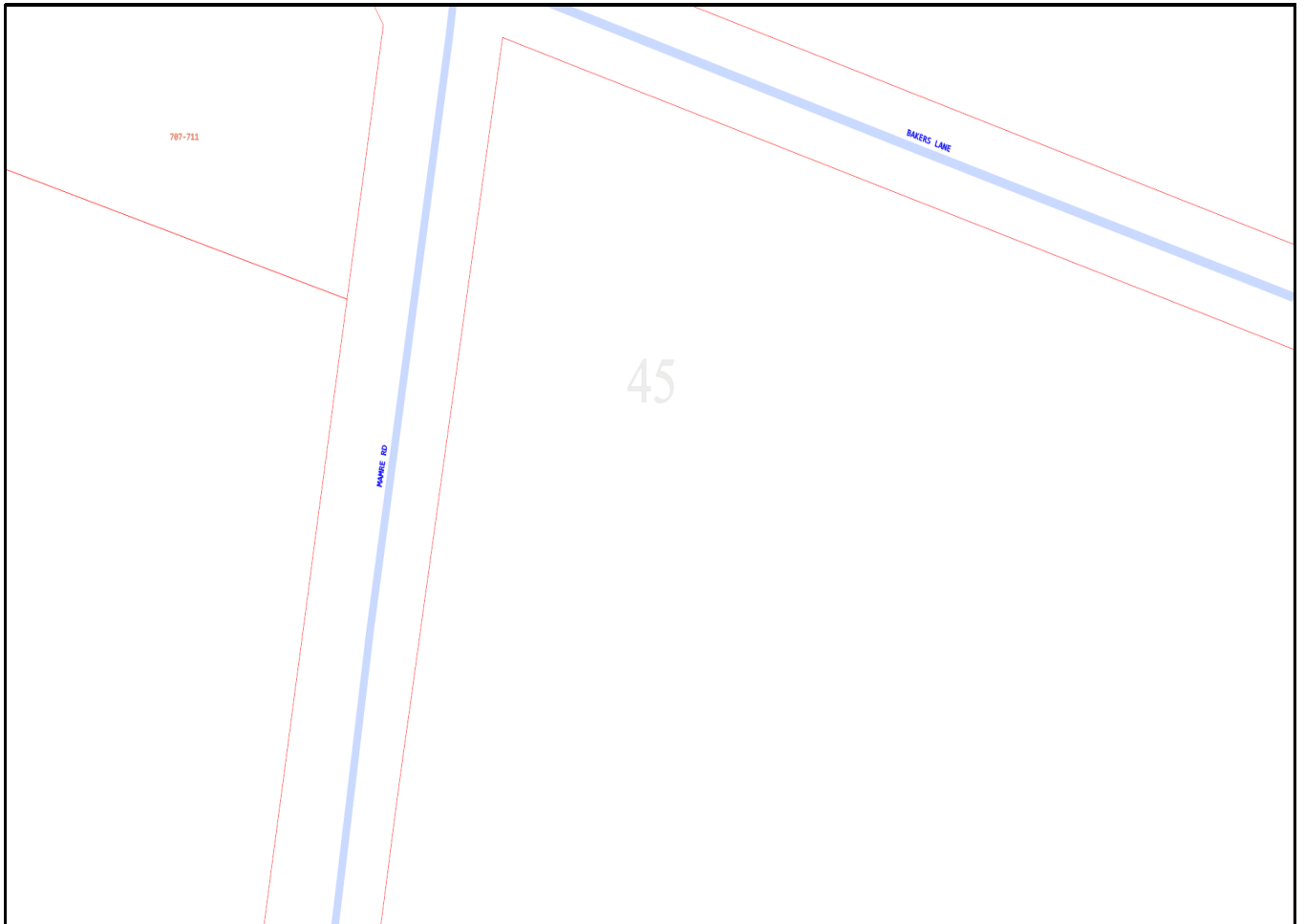

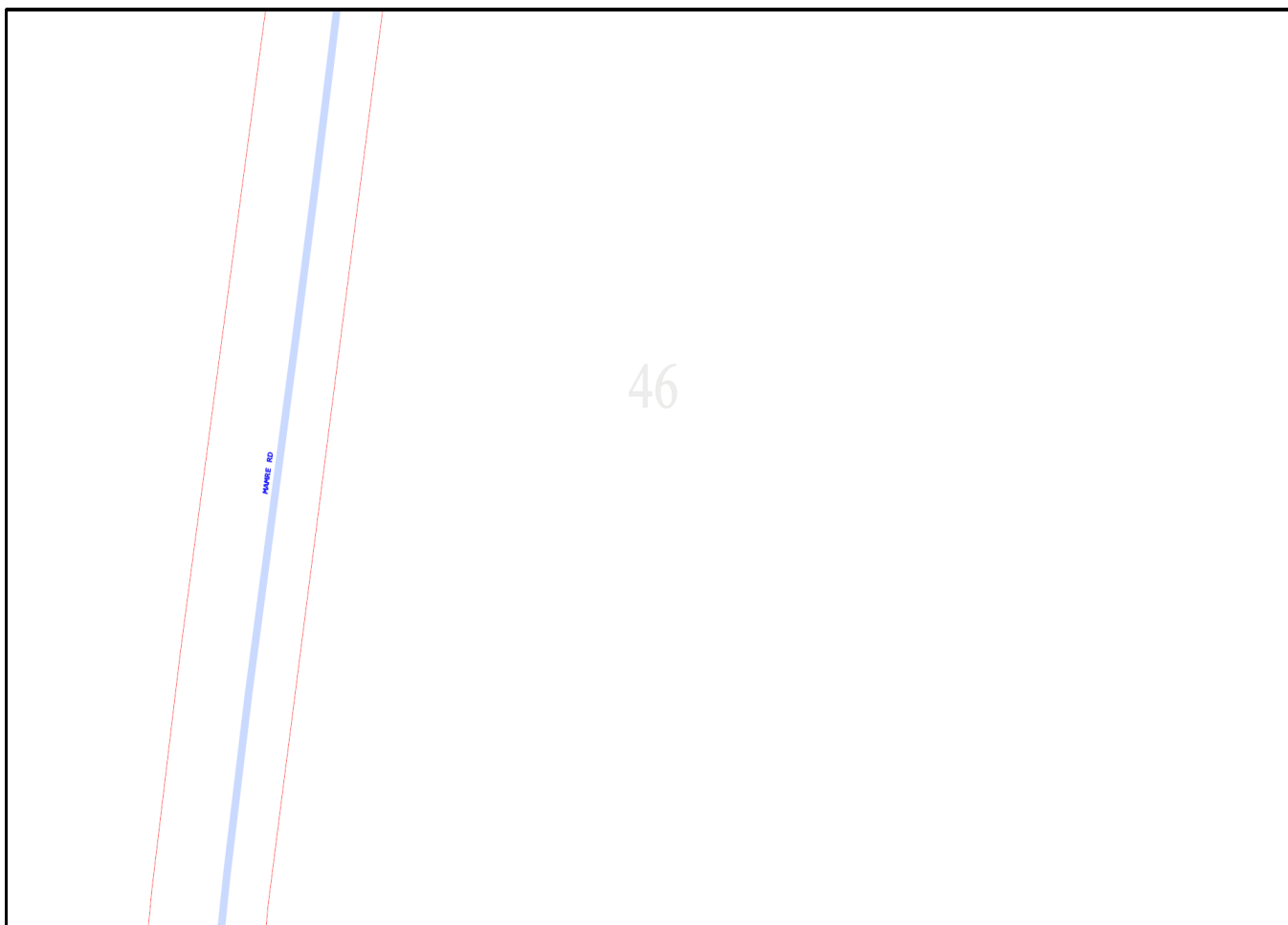

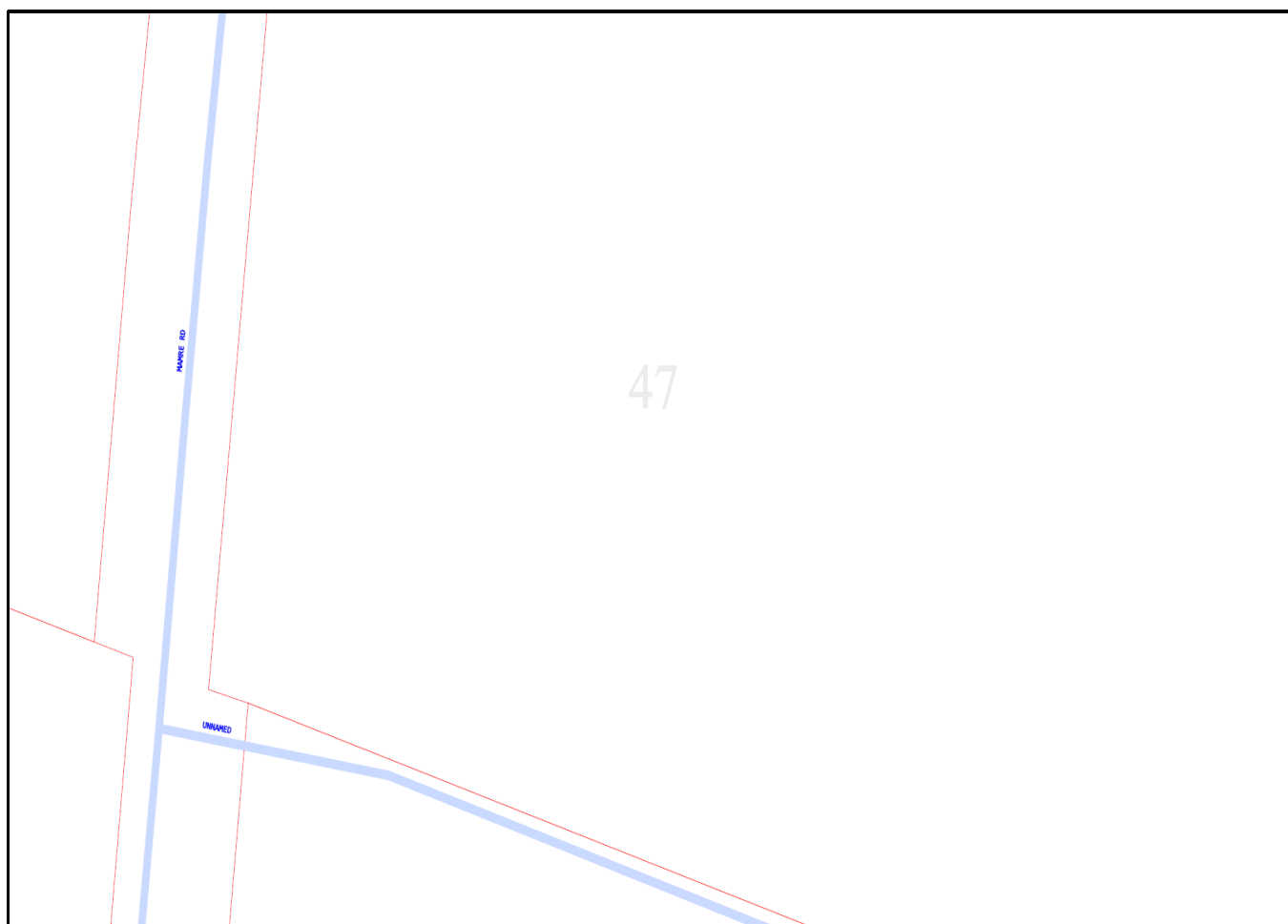

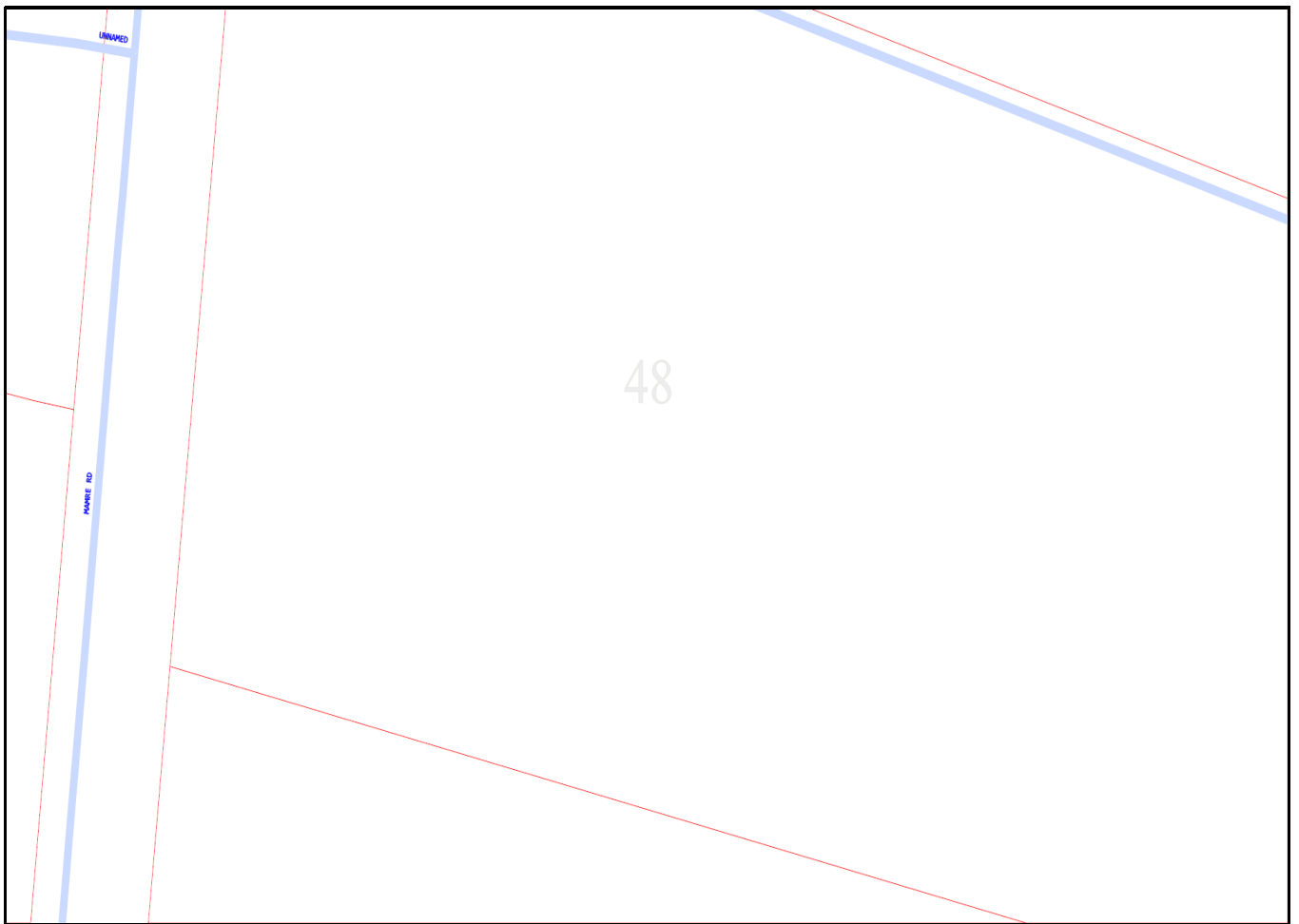

Emergency Contacts

You must immediately report any damage to **nbn**TM network that you are/become aware of. Notification may be by telephone - 1800 626 329.

A4 Roads and Maritime

DRAWN BY CADD
DO NOT AMEND MANUALLY

DATE IN SERVICE : 30/07/97

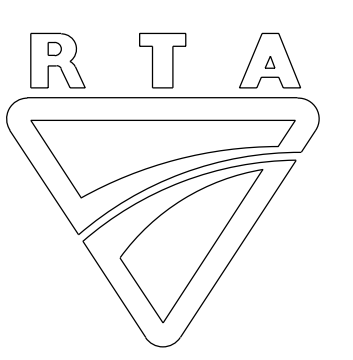

CABLE LAYOUT

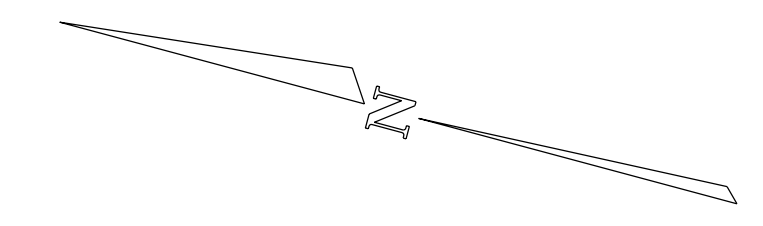
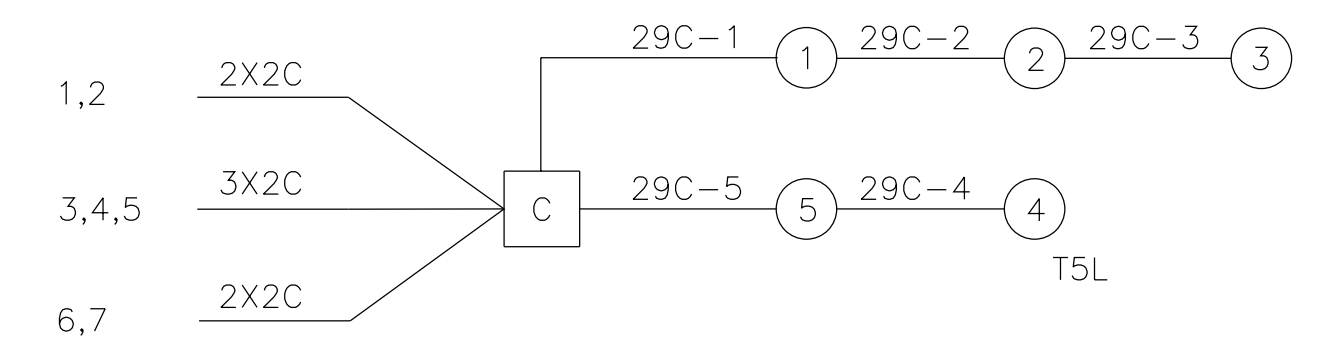

NOTES

1. ALL CABLES ARE INSTALLED IN 1 X 80 HEAVY DUTY PVC ELECTRICAL CONDUIT UNLESS OTHERWISE STATED.
2. THE COVER ABOVE CONDUITS IS 0.75m IN ROADWAYS AND 0.5m IN FOOTWAYS UNLESS OTHERWISE STATED.

0536.358.VV.3308

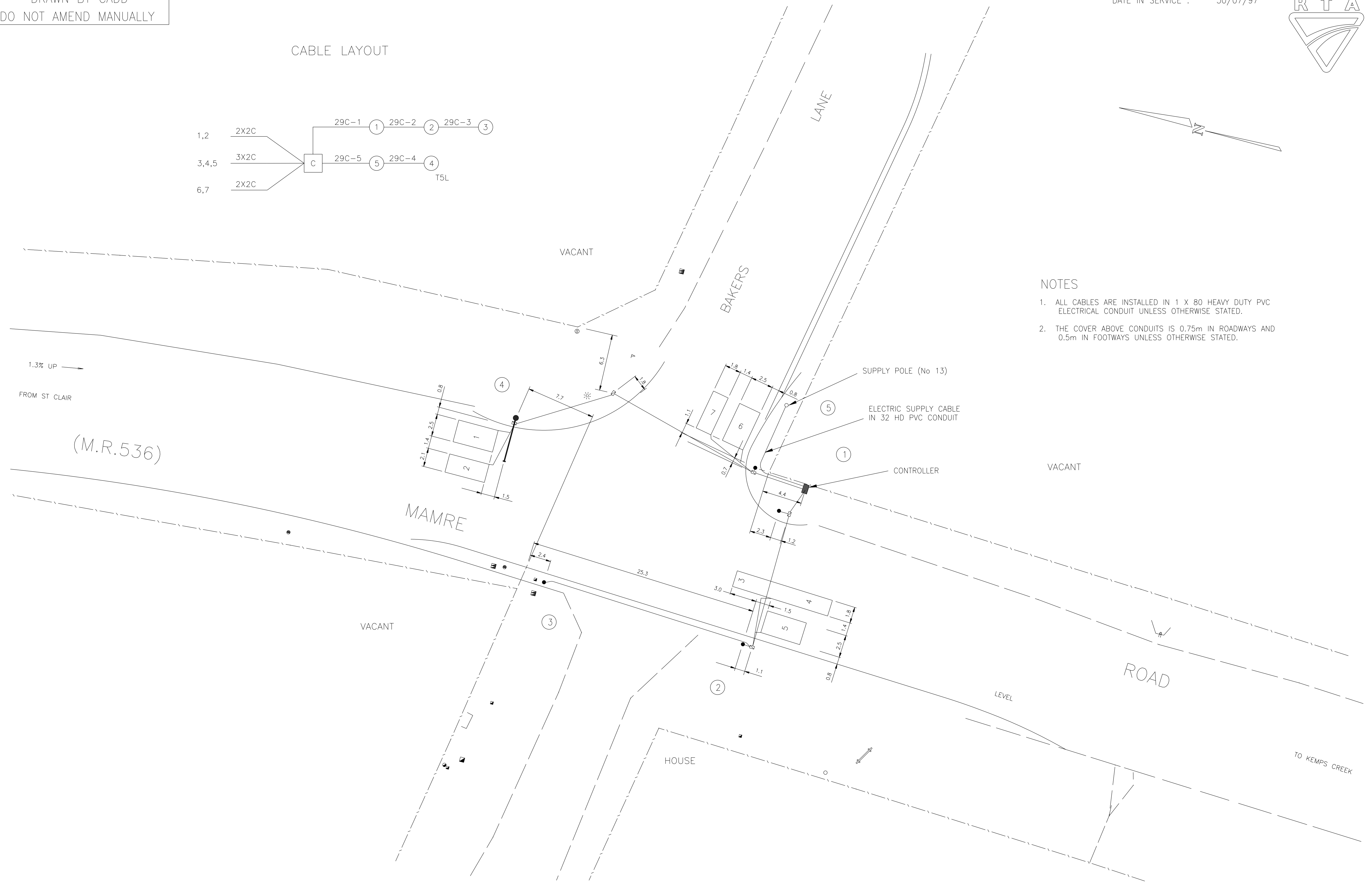

A ORIGINAL ISSUE

PUBLIC UTILITY LEGEND		REFERENCE PLANS		U.B.D. Ref. MAP 205 L12	
HYDRANT	□	SYMBOLS/ABBVS.	VD003-6	I.S.G. E:	279 622
STOP VALVE	▲	STD. POSIT.	VD001-5	CO-ORDS N:	1 255 048
GAS VALVE	#	DET. SCHED EXP.	VD018-10	DESIGNED CNJ	
SEWER MANHOLE	⊕	PRES. DETECT.	VC005-17	CHECKED	
TELECOM PIT	⊕	SSG DIS. SEQ.	VD018-8	T. McCAFFERY 08-10-97	
ELECT LIGHT POLE	⊕	DESIGN LAYOUT	SHT 1	SITE CHECKED	
POWER POLE	⊕	CABLE CHART	SHT 3	L. CLAY RECOMMENDED	
STAY POLE	⊕			DATE	09-10-97
TELEPHONE BOX	⊕	SURVEYOR	T. METHVEN		
TELECOM PILLAR	⊕	DATE	NOV 96		

APPROVED
R. C. Bird
R. C. BIRD
ELECTRICAL DESIGN MANAGER
09-10-97
DATE

Roads and Traffic Authority, N.S.W.
PENRITH COUNCIL
INTERSECTION OF (M.R.536) MAMRE ROAD
AND BAKERS LANE
KEMPS CREEK
CABLE INSTALLATION
TCS No 3308

DESIGN OFFICE PARRAMATTA - SYDNEY TECHNICAL SERVICES		CADD FILE: VV3308_2A_INS.dgn	
SCALE	5 0 (1:200) 5 10	SUPERSEDES SHEET/ISSUE	-
FILE	358 TS 243	ISSUE	A
REGN.	0536.358.VV.3308	SHEET	2

A5 Sydney Water

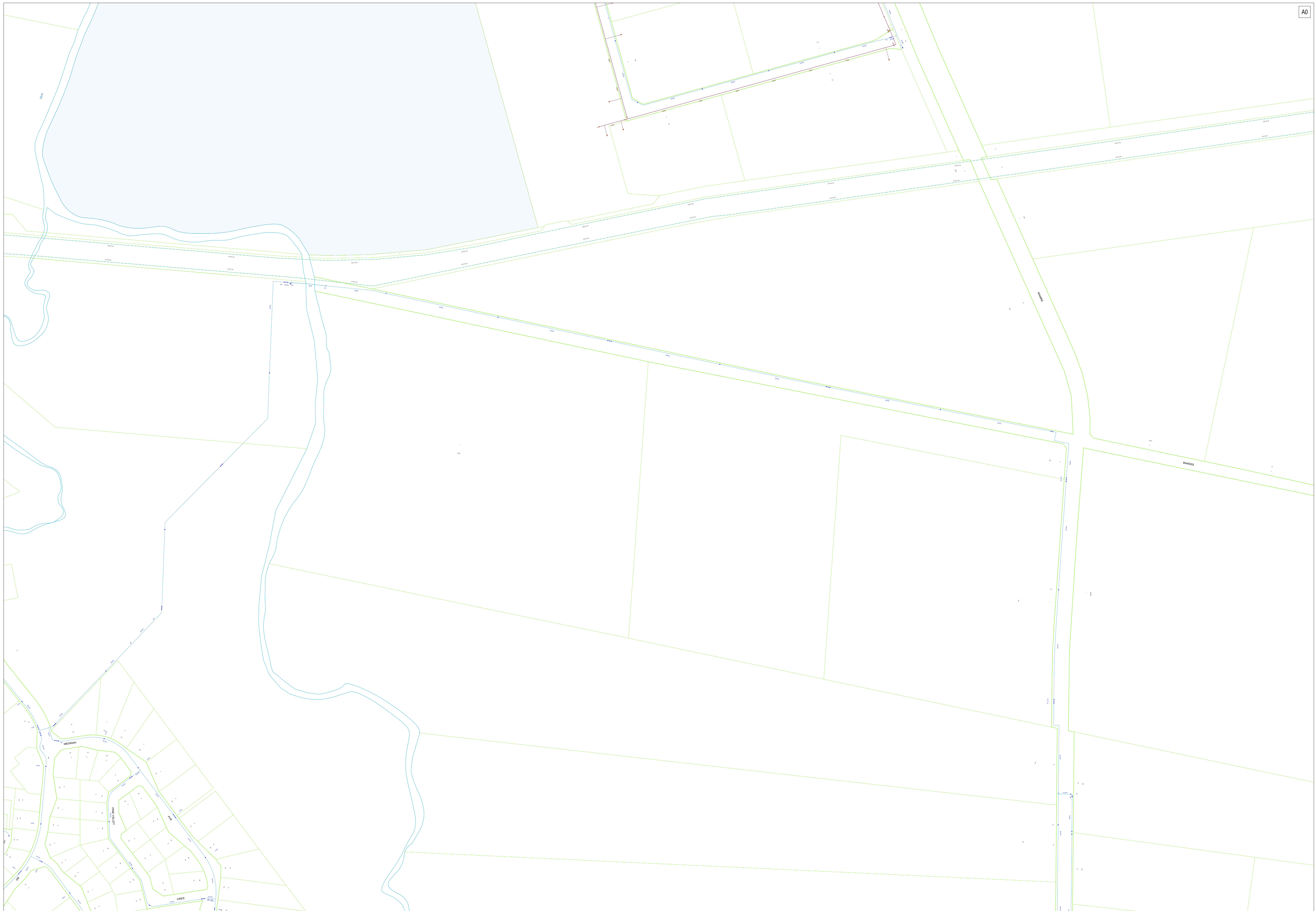

A6 Telstra

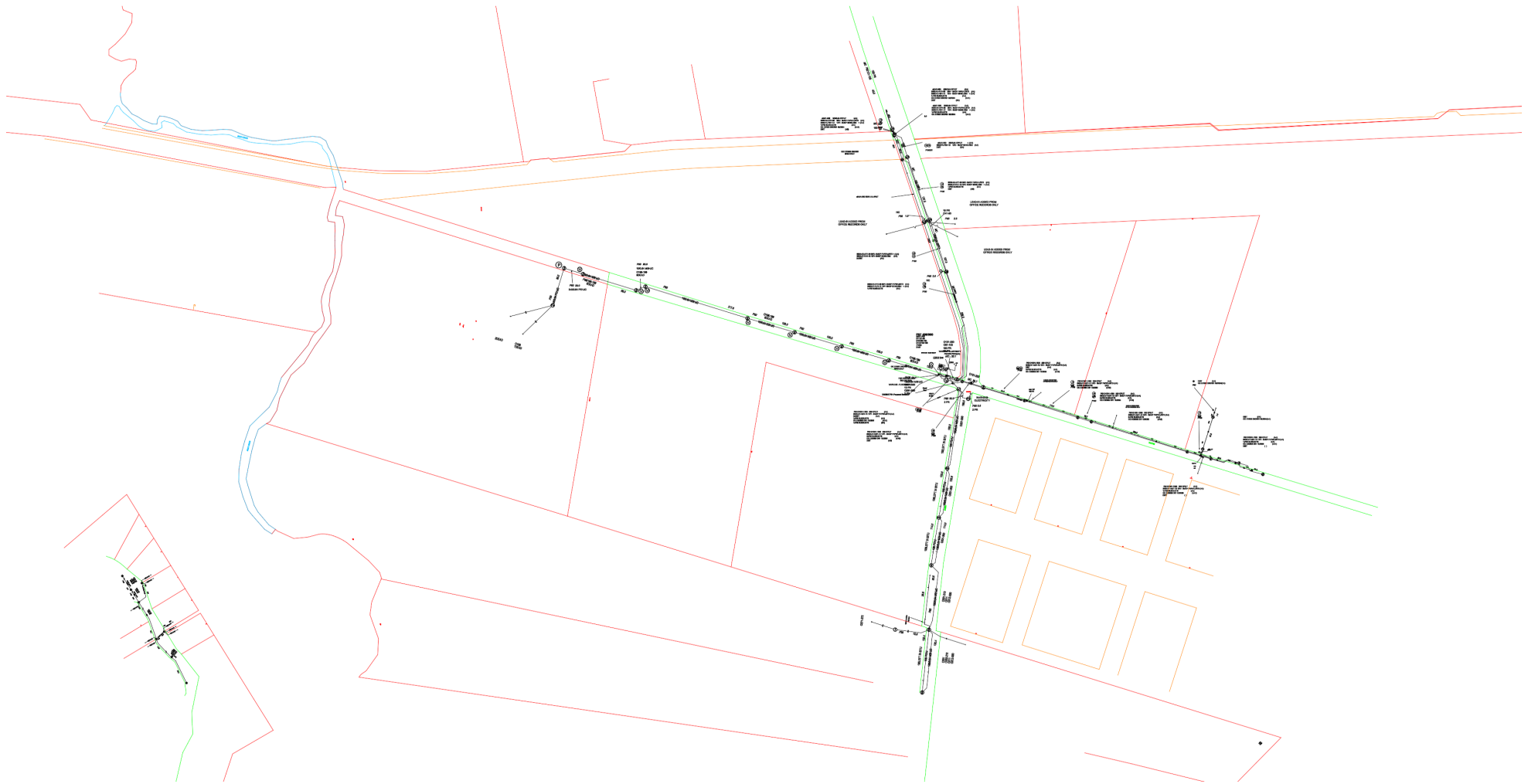



Date: 07/01/2021

Enquirer Name: Miss Ashley Nguyen
Enquirer Address: 151 Clarence Street
Email: ashley.nguyen@arup.com
Phone: 0432391589

Dear Miss Ashley Nguyen

The following is our response on behalf of each of the TPG carriers (listed below) to your Dial Before You Dig enquiry – Sequence 105300012. It is provided to you on a confidential basis under the following conditions and must be shredded or securely disposed of after use.

Assets Affected:

Carriers (each a “TPG carrier”) and assets affected:

PIPE Networks

Location: Mamre Road

According to our records, the underground assets in the vicinity of the location stated in your enquiry are **AFFECTED**. Please read the below information and disclaimers in addition to the any attached plans provided prior to any construction activities.

IMPORTANT INFORMATION

- The information provided is valid for 30 days from the date of this response. If your work site area changes or your construction activity is beyond 30 days please contact Dial Before You Dig on 1100 or www.1100.com.au to re-submit a new enquiry.
- Due to the nature of underground assets and the age of some assets and records, our plans are indicative of the general location only and may not show all assets in the location. You should not solely rely on these plans when undertaking construction works. It is also inaccurate to assume depth or that underground network conduit and cables follow straight lines, and careful on-site investigations are essential to locate an asset's exact position prior to excavation. It is your responsibility to locate and confirm the exact location of our infrastructure using non-destructive techniques. We make no warranty or guarantee that our plans are complete, current or error free, and to the maximum extent permitted by law we exclude all liability to you, your employees, agents and contractors for any loss, damage or claim arising out of or in connection with using our plans.
- Please note that some of our conduits carry electrical cables and gas pipes. Please exercise extreme care when working within the vicinity of these conduit and take into account the minimum clearance distances under Duty Of Care below.
- You (and your employee and contractors) must not open, move, interfere, alter or relocate any of our assets without our prior approval.
- **Note** It is a criminal offence under the *Criminal Code Act 1995 (Cth)* to tamper or interfere with communication facilities owned by a carrier. Heavy penalties may apply for breach of this prohibition, and any damages suffered, or costs incurred by us as a result of such unauthorised works may be claimed against you.

DAMAGE

- You must report immediately any damage to our network on **1800 786 306** (24hrs). We will hold you liable and seek compensation for any loss or damage to our network, our property and our customers that is caused by or arises out of your activities.

DUTY OF CARE

You have a duty of care to carefully locate, validate and protect our assets when carrying out works near our infrastructure. For construction activities that may impact on or interfere with our network, you will need to call us on **1800 786 306** to discuss a suitable engineering solution, lead time and cost involved. The below precautions must be taken when working in the vicinity of our network:

- Contact us on **1800 786 306** to discuss and obtain relevant information and plans on our infrastructure in a particular location if the information provided in this response is insufficient.
- Physically locate and mark on-site our network infrastructure using non-destructive techniques i.e. pot holing or hand digging every 5 metres prior to commencing any construction activities. Assets located must be marked to AS5488 standard. **NO CONSTRUCTION WORK IS ALLOWED UNTIL THIS STEP IS COMPLETED.** You must use an approved telecommunications accredited locator, or we can provide a locator for you at your expense. If we provide you with a locator, and this locator attended the site and is proven to be grossly negligent in physically locating and marking our infrastructure, then to the extent any TPG carrier is liable for this locator's negligence, acts and omissions, the total liability aggregated for all TPG carriers is limited, at our option, to attend the site and re-mark the infrastructure or to pay for a third party to re-mark the infrastructure.
- If you require us to locate or monitor our infrastructure, please allow five business days' notice for us to respond.
- Ensure all information, including our network requirements and any associated plans provided by us are kept confidential and remain on-site throughout your construction works.

- Use suitably qualified and supervised professionals, particularly if you are working near assets that contain electricity cables or gas pipes.
- Ensure the below minimum clearance distances between the construction activities and the actual location of our assets are met. If you need clearance distances for our above ground assets, or if the below distances cannot be met, call **1800 786 306** to discuss.

Minimum assets clearance distances.

- 300mm when laying asset in-line, horizontal or vertical.
 - 1000mm when operating vibrating equipment. Eg: vibrating plates. No vibrating equipment on top of asset.
 - 1000mm when operating mechanical excavators or jackhammers/pneumatic breakers.
 - 2000mm when performing directional bore in-line, horizontal and vertical.
 - No heavy vehicle over 3 tonnes to be driven over asset with less than 600mm of cover.
- Reinstate exposed TPG network infrastructure back to original state.

PRIVACY & CONFIDENTIALITY

- Privacy Notice – Your information has been provided to us by Dial Before You Dig to respond to your Dial Before You Dig enquiry. We will keep your personal information in accordance with TPG’s privacy policy, see www.tpg.com.au/about/privacy.
- Confidentiality – The information we have provided to you is confidential and is to be used only for planning and designing purposes in connection with your Dial Before You Dig enquiry. Please dispose of the information by shredding or other secure disposal method after use. We retain all intellectual property rights (including copyrights) in all our documents and plans.

Overview Map

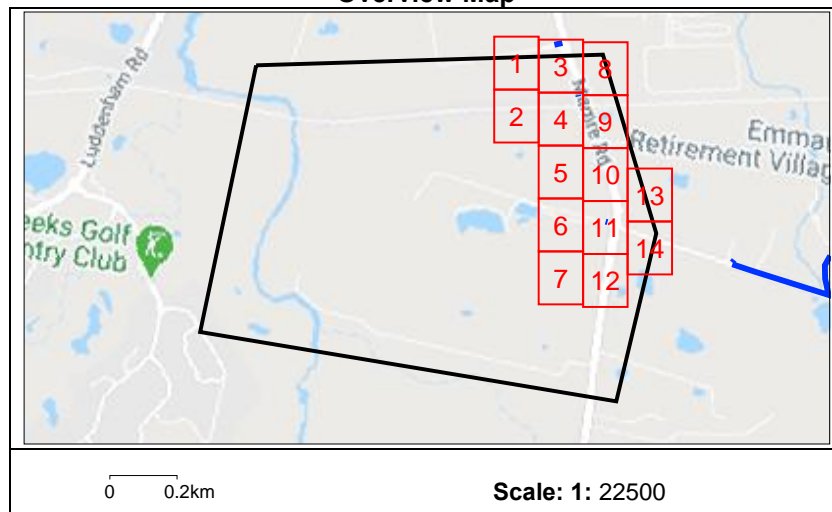

TPG Corporation Limited

1



Distribution Dr.

Distribution Dr.

Enquiry Number: 105300012

Map Sheet: 1

Scale: 1: 750

0 0.008km



LEGEND

DBYD Work Area



AAPT/PowerTel Pit



AAPT/PowerTel Duct



DDA Pit



DDA Duct



Agile/Adam Pit



Agile/Adam Duct



TransACT Pit



TransACT Duct



SOUL Pattinson Telecoms Pit



SOUL Pattinson Telecoms Duct



PIPE Networks Pit



PIPE Networks Duct



DISCLAIMER: No responsibility/liability is taken by TPG Corporation Limited for any inaccuracy, error, omission or action based on the information supplied in this correspondence. © 2020 TPG Corporation Limited.

2

Enquiry Number: 105300012

Map Sheet: 2

Scale: 1: 750

0 0.008km



LEGEND

DBYD Work Area



AAPT/PowerTel Pit



AAPT/PowerTel Duct



DDA Pit



DDA Duct



Agile/Adam Pit



Agile/Adam Duct



TransACT Pit



TransACT Duct



SOUL Pattinson Telecoms Pit



SOUL Pattinson Telecoms Duct



PIPE Networks Pit



PIPE Networks Duct



DISCLAIMER: No responsibility/liability is taken by TPG Corporation Limited for any inaccuracy, error, omission or action based on the information supplied in this correspondence. © 2020 TPG Corporation Limited.

3

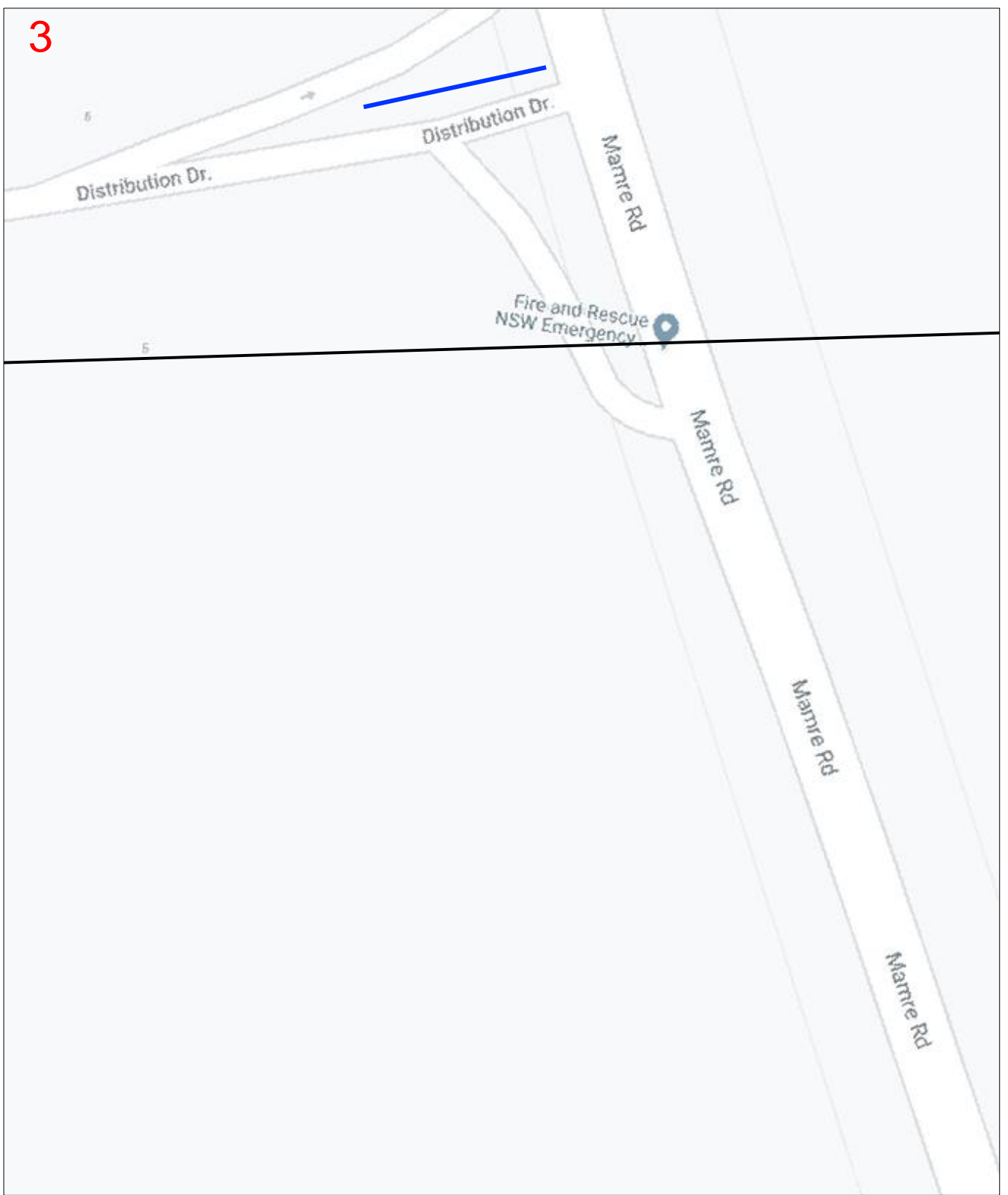

Enquiry Number: 105300012

Map Sheet: 3

Scale: 1: 750

0 0.008km



LEGEND

DBYD Work Area



AAPT/PowerTel Pit



AAPT/PowerTel Duct



DDA Pit



DDA Duct



Agile/Adam Pit



Agile/Adam Duct



TransACT Pit



TransACT Duct



SOUL Pattinson Telecoms Pit



SOUL Pattinson Telecoms Duct



PIPE Networks Pit



PIPE Networks Duct



DISCLAIMER: No responsibility/liability is taken by TPG Corporation Limited for any inaccuracy, error, omission or action based on the information supplied in this correspondence. © 2020 TPG Corporation Limited.

4

Enquiry Number: 105300012

Map Sheet: 4

Scale: 1: 750

0 0.008km



LEGEND

DBYD Work Area



AAPT/PowerTel Pit



AAPT/PowerTel Duct



DDA Pit



DDA Duct



Agile/Adam Pit



Agile/Adam Duct



TransACT Pit



TransACT Duct



SOUL Pattinson Telecoms Pit



SOUL Pattinson Telecoms Duct



PIPE Networks Pit



PIPE Networks Duct



DISCLAIMER: No responsibility/liability is taken by TPG Corporation Limited for any inaccuracy, error, omission or action based on the information supplied in this correspondence. © 2020 TPG Corporation Limited.

5

Enquiry Number: 105300012

Map Sheet: 5

Scale: 1: 750

0 0.008km



LEGEND

DBYD Work Area



AAPT/PowerTel Pit



AAPT/PowerTel Duct



DDA Pit



DDA Duct



Agile/Adam Pit



Agile/Adam Duct



TransACT Pit



TransACT Duct



SOUL Pattinson Telecoms Pit



SOUL Pattinson Telecoms Duct



PIPE Networks Pit



PIPE Networks Duct



DISCLAIMER: No responsibility/liability is taken by TPG Corporation Limited for any inaccuracy, error, omission or action based on the information supplied in this correspondence. © 2020 TPG Corporation Limited.

6

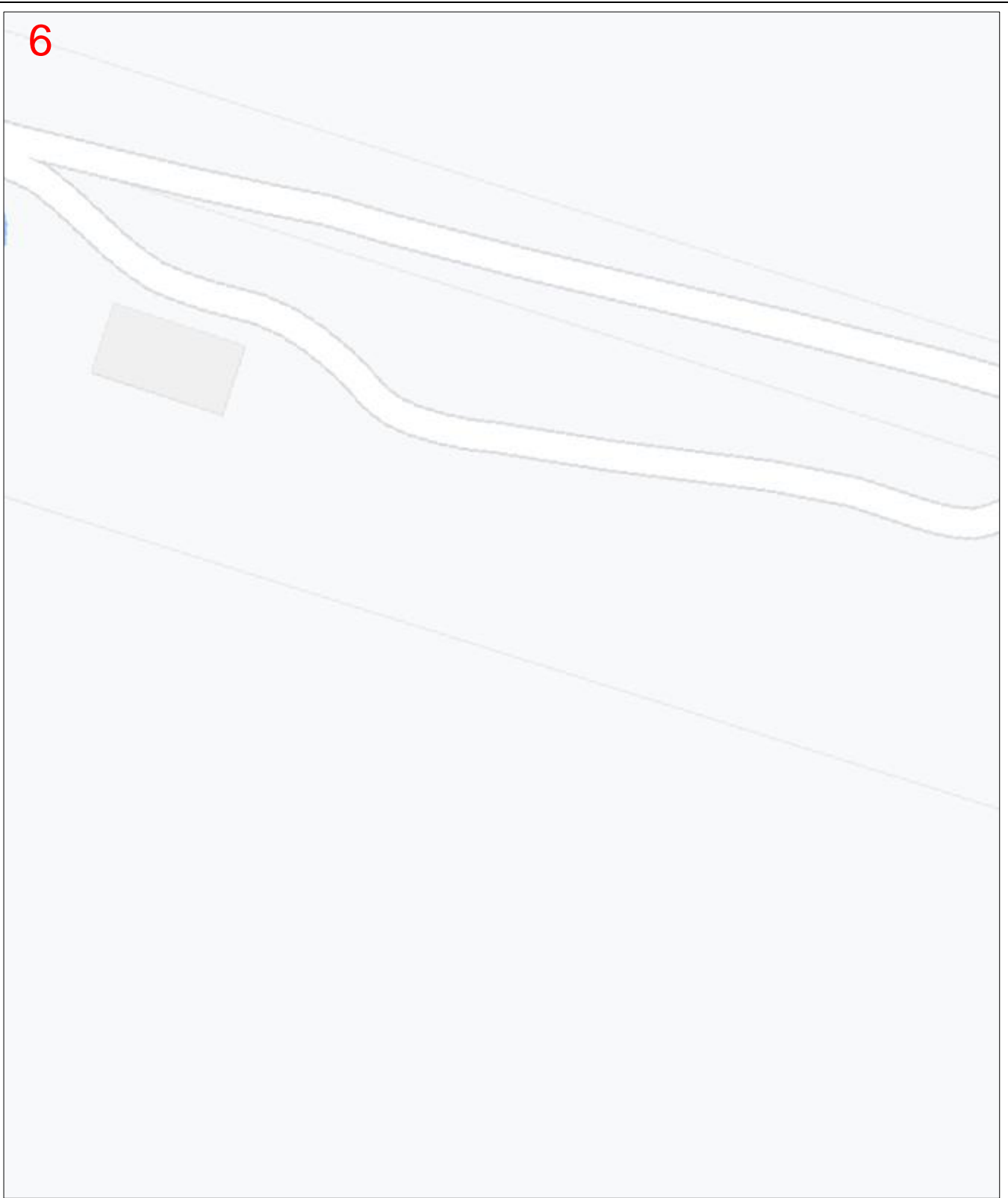

Enquiry Number: 105300012

Map Sheet: 6

Scale: 1: 750

0 0.008km



LEGEND

DBYD Work Area



AAPT/PowerTel Pit



AAPT/PowerTel Duct



DDA Pit



DDA Duct



Agile/Adam Pit



Agile/Adam Duct



TransACT Pit



TransACT Duct



SOUL Pattinson Telecoms Pit



SOUL Pattinson Telecoms Duct



PIPE Networks Pit



PIPE Networks Duct



DISCLAIMER: No responsibility/liability is taken by TPG Corporation Limited for any inaccuracy, error, omission or action based on the information supplied in this correspondence. © 2020 TPG Corporation Limited.

7

713

Enquiry Number: 105300012

Map Sheet: 7

Scale: 1: 750

0 0.008km



LEGEND

DBYD Work Area



AAPT/PowerTel Pit



AAPT/PowerTel Duct



DDA Pit



DDA Duct



Agile/Adam Pit



Agile/Adam Duct



TransACT Pit



TransACT Duct



SOUL Pattinson Telecoms Pit



SOUL Pattinson Telecoms Duct



PIPE Networks Pit



PIPE Networks Duct



DISCLAIMER: No responsibility/liability is taken by TPG Corporation Limited for any inaccuracy, error, omission or action based on the information supplied in this correspondence. © 2020 TPG Corporation Limited.

8



Enquiry Number: 105300012

Map Sheet: 8

Scale: 1: 750

0 0.008km



LEGEND

DBYD Work Area



AAPT/PowerTel Pit



AAPT/PowerTel Duct



DDA Pit



DDA Duct



Agile/Adam Pit



Agile/Adam Duct



TransACT Pit



TransACT Duct



SOUL Pattinson Telecoms Pit



SOUL Pattinson Telecoms Duct



PIPE Networks Pit



PIPE Networks Duct



DISCLAIMER: No responsibility/liability is taken by TPG Corporation Limited for any inaccuracy, error, omission or action based on the information supplied in this correspondence. © 2020 TPG Corporation Limited.

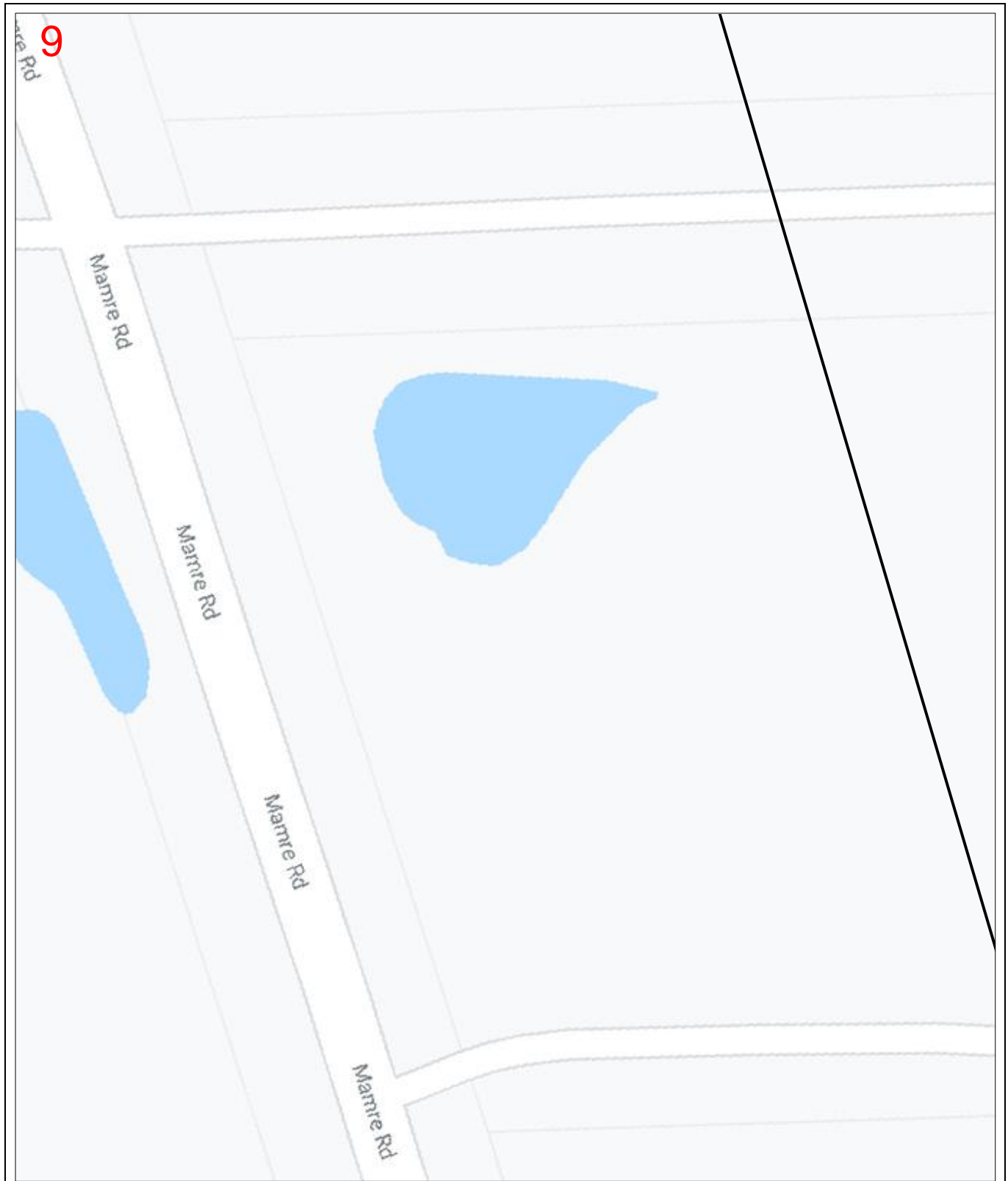

Enquiry Number: 105300012

Map Sheet: 9

Scale: 1: 750

0 0.008km



LEGEND

DBYD Work Area



AAPT/PowerTel Pit



AAPT/PowerTel Duct



DDA Pit



DDA Duct



Agile/Adam Pit



Agile/Adam Duct



TransACT Pit



TransACT Duct



SOUL Pattinson Telecoms Pit



SOUL Pattinson Telecoms Duct



PIPE Networks Pit



PIPE Networks Duct



DISCLAIMER: No responsibility/liability is taken by TPG Corporation Limited for any inaccuracy, error, omission or action based on the information supplied in this correspondence. © 2020 TPG Corporation Limited.

10



Enquiry Number: 105300012

Map Sheet: 10

Scale: 1: 750

0 0.008km



LEGEND

DBYD Work Area



AAPT/PowerTel Pit



AAPT/PowerTel Duct



DDA Pit



DDA Duct



Agile/Adam Pit



Agile/Adam Duct



TransACT Pit



TransACT Duct



SOUL Pattinson Telecoms Pit



SOUL Pattinson Telecoms Duct



PIPE Networks Pit



PIPE Networks Duct



DISCLAIMER: No responsibility/liability is taken by TPG Corporation Limited for any inaccuracy, error, omission or action based on the information supplied in this correspondence. © 2020 TPG Corporation Limited.

11

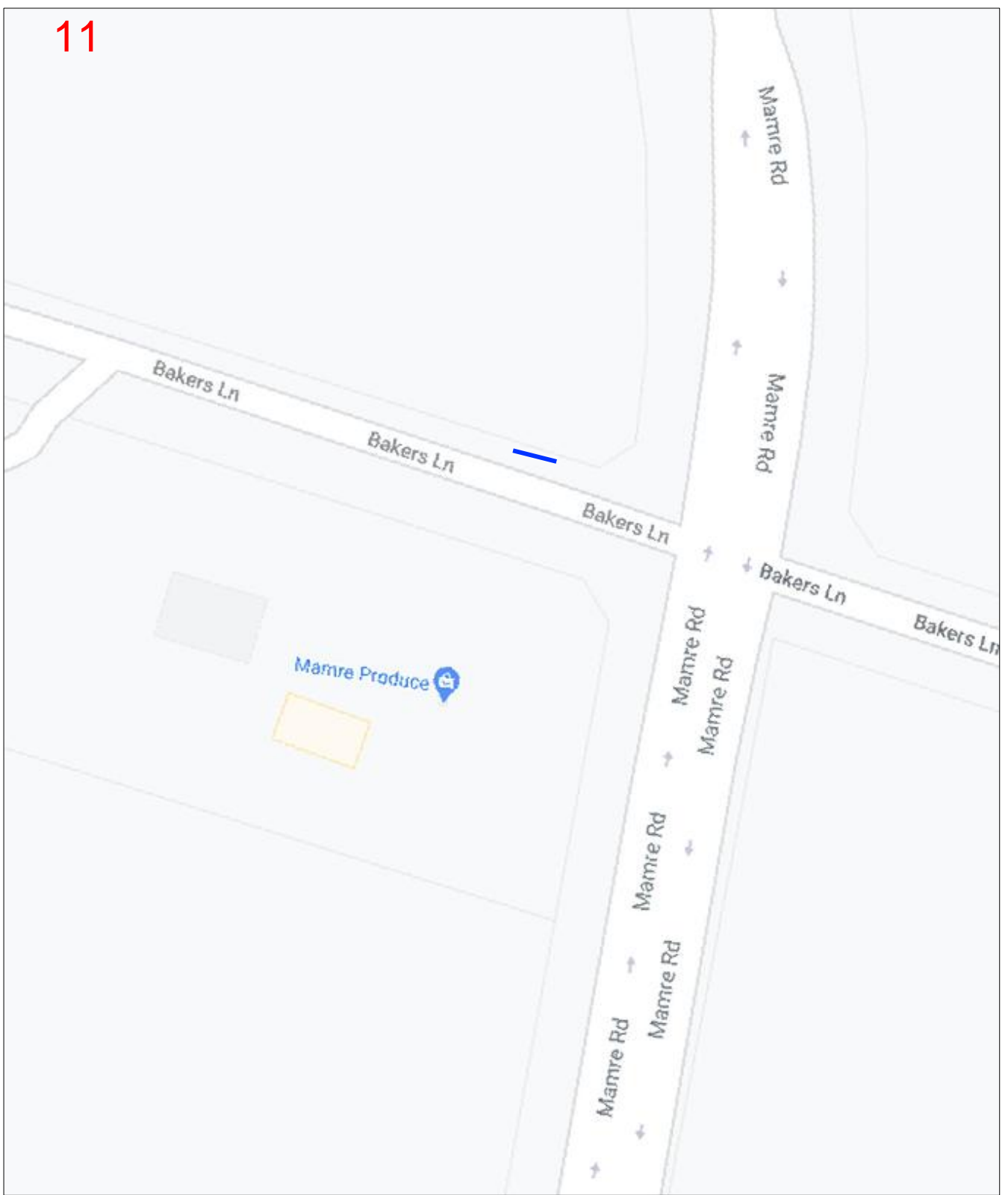

Enquiry Number: 105300012

Map Sheet: 11

Scale: 1: 750

0 0.008km



LEGEND

DBYD Work Area



- | | | | |
|--------------------|--|------------------------------|--|
| AAPT/PowerTel Pit | | TransACT Pit | |
| AAPT/PowerTel Duct | | TransACT Duct | |
| DDA Pit | | SOUL Pattinson Telecoms Pit | |
| DDA Duct | | SOUL Pattinson Telecoms Duct | |
| Agile/Adam Pit | | PIPE Networks Pit | |
| Agile/Adam Duct | | PIPE Networks Duct | |

DISCLAIMER: No responsibility/liability is taken by TPG Corporation Limited for any inaccuracy, error, omission or action based on the information supplied in this correspondence. © 2020 TPG Corporation Limited.

12

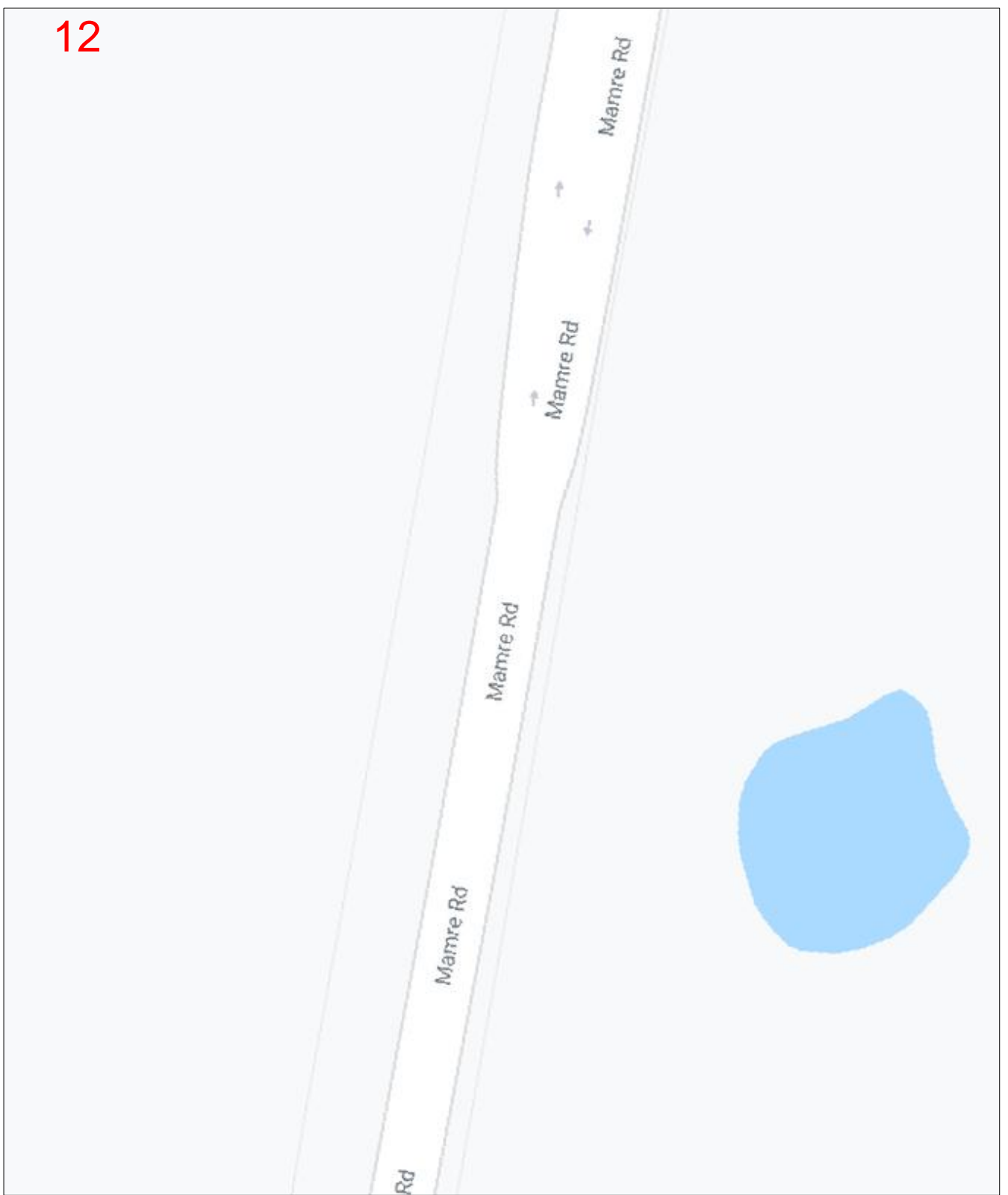

Enquiry Number: 105300012

Map Sheet: 12

Scale: 1: 750

0 0.008km



LEGEND

DBYD Work Area



AAPT/PowerTel Pit



TransACT Pit



AAPT/PowerTel Duct



TransACT Duct



DDA Pit



SOUL Pattinson Telecoms Pit



DDA Duct



SOUL Pattinson Telecoms Duct



Agile/Adam Pit



PIPE Networks Pit



Agile/Adam Duct



PIPE Networks Duct



DISCLAIMER: No responsibility/liability is taken by TPG Corporation Limited for any inaccuracy, error, omission or action based on the information supplied in this correspondence. © 2020 TPG Corporation Limited.

13

696

Enquiry Number: 105300012

Map Sheet: 13

Scale: 1: 750

0 0.008km



LEGEND

DBYD Work Area



AAPT/PowerTel Pit



AAPT/PowerTel Duct



DDA Pit



DDA Duct



Agile/Adam Pit



Agile/Adam Duct



TransACT Pit



TransACT Duct



SOUL Pattinson Telecoms Pit



SOUL Pattinson Telecoms Duct



PIPE Networks Pit



PIPE Networks Duct



DISCLAIMER: No responsibility/liability is taken by TPG Corporation Limited for any inaccuracy, error, omission or action based on the information supplied in this correspondence. © 2020 TPG Corporation Limited.

14

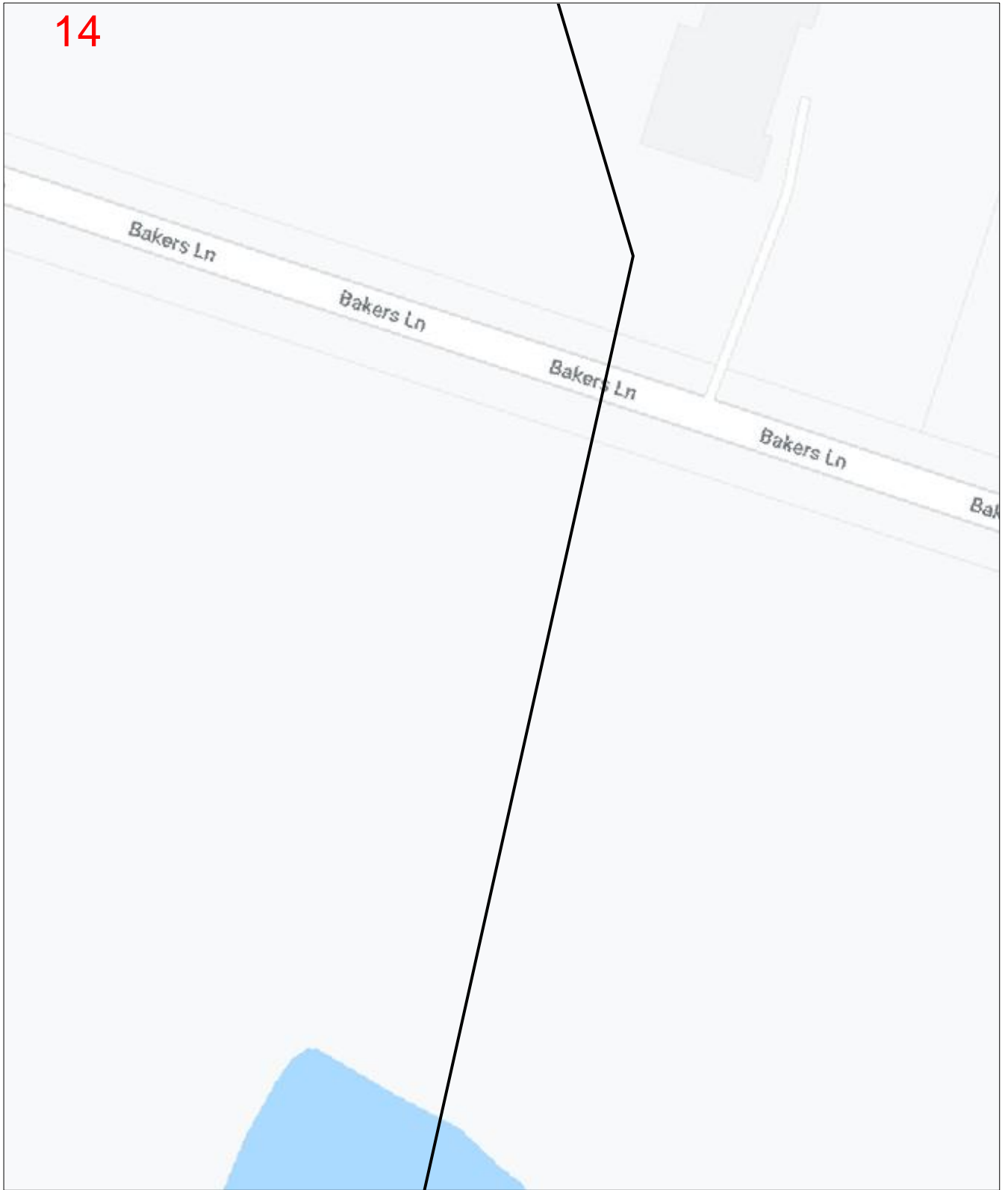

Enquiry Number: 105300012

Map Sheet: 14

Scale: 1: 750

0 0.008km



LEGEND

DBYD Work Area



AAPT/PowerTel Pit



AAPT/PowerTel Duct



DDA Pit



DDA Duct



Agile/Adam Pit



Agile/Adam Duct



TransACT Pit



TransACT Duct



SOUL Pattinson Telecoms Pit



SOUL Pattinson Telecoms Duct



PIPE Networks Pit



PIPE Networks Duct



DISCLAIMER: No responsibility/liability is taken by TPG Corporation Limited for any inaccuracy, error, omission or action based on the information supplied in this correspondence. © 2020 TPG Corporation Limited.

Appendix B

Electrical Consultations

B1 Endeavour Energy Consultations

Application for Connection of Permanent Load including all Strata Developments



Please return completed form along with all attachments to: Endeavour Energy, PO Box 811 Seven Hills NSW 1730
 Email: cwadmin@endeavourenergy.com.au | Fax: 02 9853 7925 | For connection enquiries, please contact 133 718

This form is to be used where connection of load or increase in load applications are required for all multi occupant developments, commercial premises, urban loads greater than 100 amps single phase or 63 amps three phase, rural connections and upgrades, and high voltage connections. (For urban connections less than 100 amps single phase or 63 amps three phase please complete an online application visit: www.endeavourenergy.com.au).
Note: For Temporary Builders Supply (TBS) use FPJ 6011 – Application for Temporary Builder Supply (TBS).
All information requested should be provided. Where not applicable please insert N/A.
Applications submitted with inadequate information will not be accepted.

Retail Customer Details Not applicable
 In order for your application to be accepted, you must have a Retail Electricity account with the Retailer of your choice for your site and a National Meter Identifier (NMI). Please indicate below.
 Retail Company _____ NMI _____
 Customer Name _____
Further information regarding establishing a Retail account and choosing a Retailer can be found at http://www.ipart.nsw.gov.au/Home/For_Consumers/Choosing_an_energy_supplier

Site Details

Lot & DP No. 22 / DP258414 Street No. 757 Street Name Mamre Road
 Cross Street _____ Suburb / Town Kemps Creek Post Code 2178
 Local Council / Shire _____ UBD Map & Reference No. _____/_____
 Nearest Substation No. _____ Adjacent Pole No. _____ Pillar No. _____
 New Connection Existing Service Upgrade (3 phase)
 Additional Load
 Please list any related Endeavour Energy CAP reference: ENL3688 – 2014/02306/001
 Date permanent supply is required 01 / 04 / 2022
 Specify Land Zoning (For land zoning, refer to local Council, Development Application or Rates Notice) _____
 Development Type: Domestic Commercial Shop Industrial
 Government Utilities Other Specify Data centre
 Units, No. of Units _____ (Please provide NMI's for each unit as an attachment to this application)
 Gas reticulation on site Yes No
 Footpaths/driveways to be constructed on site Yes No

Load Details

Calculated Maximum Demand Summary				
	A	B	C	
Removed Load	See MD attached			Amps
Existing Load				Amps
Additional Load				Amps
Total Load				Amps

Number of phases required: Single Phase Three Phase

* **Maximum demand assessment** based on AS3000 **must** be attached
 * For **multi-residential developments** please provide details of floor area, in squares, for each unit on a separate attachment.
 * For **industrial/commercial developments** with uniform load, provide building area and VA/m² showing kVA and amps.
 * For **larger developments** supporting load details **must** be provided on a separate attachment.

Load Details (Continued)

Load details need to be completed by an electrical qualified person. For multiple occupancy residential premises, villas, units, townhouses, etc, calculate the maximum demand using AS/NZS 3000. The final load assessment will be carried out by Endeavour Energy and the assessed load may be lower or higher than the applied load.

Note:

Please provide detailed information describing your development with site plans and **a copy of the Development Agreement (DA)** as attachments to support your request including harmonic loads, excessive motor starting or other types of load that may cause quality of supply issues on the network.

Applicant Contact Details

Name / Company [REDACTED] Contact Person [REDACTED]
Street No. _____ Street Name _____
PO Box _____ Suburb / Town _____ Post Code _____
Phone _____ Mobile _____ Fax _____
Email [REDACTED]

Applicant's Representatives Contact Details

Name / Company Arup Contact Person Charlotte Ware
Street No. 151 Street Name Clarence St
PO Box _____ Suburb / Town Sydney Post Code 2000
Phone 93209077 Mobile _____ Fax _____
Email charlotte.ware@arup.com

All correspondence to be sent to (select ONE only): Applicant Applicant's Representative

Applicant's Acknowledgement and Agreement

I acknowledge and agree that:

1. in signing and submitting this application I am requesting an expedited connection;
2. I have read and understood the terms of Endeavour Energy's Model Standard Offers for a LV Basic Connection Service and Standard Connection Service (as published on its website at www.endeavourenergy.com.au) and a connection offer by Endeavour Energy for a LV Basic Connection Service or Standard Connection Service on the terms of the relevant Model Standing Offer is acceptable to me; and
3. if Endeavour Energy is satisfied that the service requested by me falls within the terms of Endeavour Energy's Model Standing Offer for either a LV Basic Connection Service or Standard Connection Service, then I will have taken to have accepted a connection offer by Endeavour Energy on the terms of the relevant Model Standing Offer on the date that Endeavour Energy receives this application.

Applicant's/Applicant's Representative Signature:

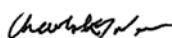

Date: 25 / 08 / 2020

* **Do you consent to the release of your contact details to other customers with similar works in progress nearby to facilitate co-operation in design and construction activities.** Yes No

Kevin Nuner
 Endeavour Energy
 PO Box 811
 Seven Hills
 NSW 1730

Arup, Level 5, Barrack Place
 151 Clarence St
 Sydney NSW 2000
 Australia
 t +61 2 9320 9077

charlotte.ware@arup.com
 www.arup.com

24 March 2020

Dear Kevin,

AZ3 - Kemps Creek

Arup have been appointed by [REDACTED] to carry out early investigation into power availability for a proposed data centre campus. The proposed site is at 757 Mamre Road, Kemps Creek, NSW 2179. The site area is marked in green and pink below:



The table below summarises the expected ultimate load for the site:

<i>Item</i>	Estimated Ultimate Load
<i>IT Equipment</i>	130 MVA
<i>Mechanical Equipment</i>	45 MVA
Total Load	175 MVA

The calculated load of 175MVA (~766A at 132kV) may vary based on final equipment selections and ongoing design development.

The table below outlines anticipated load growth over the number of years.

Year	Estimated site load (MW)	Estimated site load (MVA)
2022 Q2	13.0	13.6
2023 Q3	11.3	11.9
2024 Q3	22.7	23.9
2025 Q3	34.0	35.8

2026 Q3	45.4	47.7
2027 Q3	56.7	59.7
2028 Q3	68.0	71.6
2029 Q3	79.4	83.6
2030 Q3	90.7	95.5
2031 Q3	102.1	107.4
2032 Q3	113.4	119.4
2033 Q3	124.7	131.3
2034 Q3	136.1	143.2
2035 Q3	147.4	155.2
2036 Q3	158.8	167.1
2037 Q3	166.3	175.1

require N+1 redundancy from the utility to serve the site.

It is anticipated that an 11 or 22kV temporary supply will be required until the 132kV supply is available.

To meet redundancy requirements for the site, the switching station will be configured in an arrangement equivalent to the below:

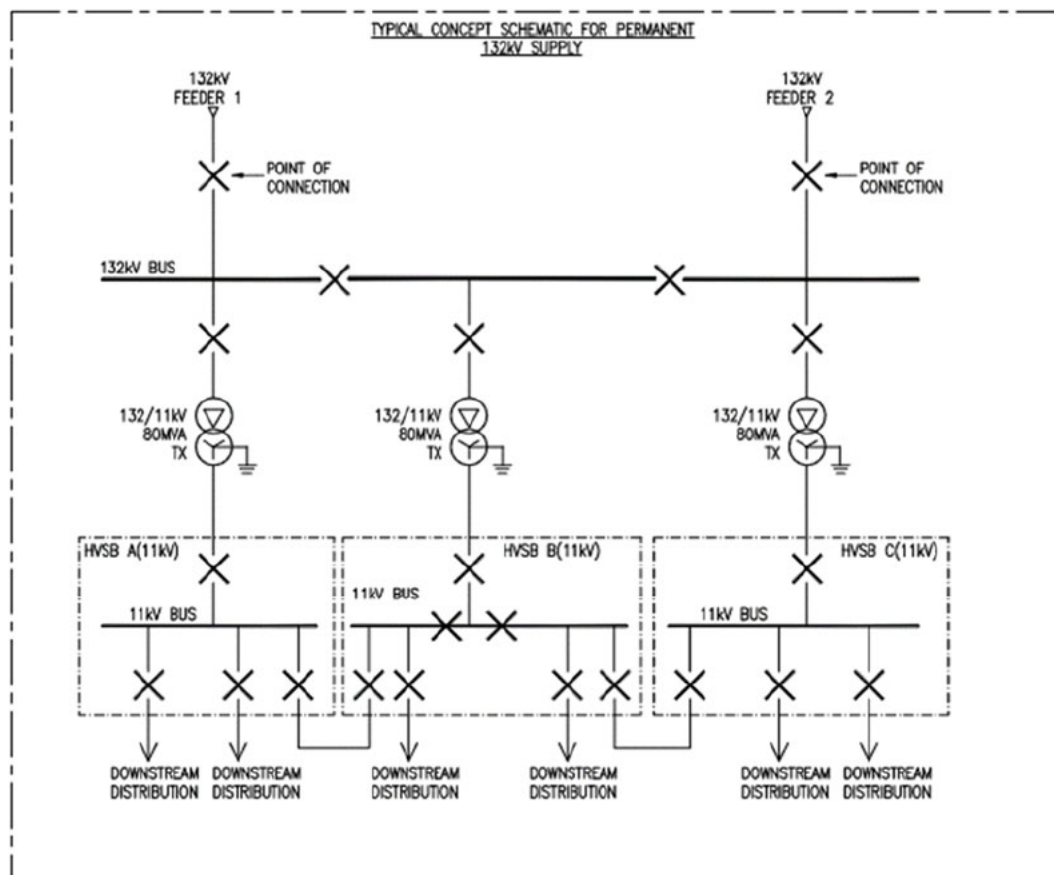

A key interlocking system will be provided to prevent paralleling of the incoming 132kV feeders. Standby generators will be provided downstream for emergency standby use only and are not intended to operate in parallel with the utility supplies at any time – suitable transfer switching equipment will be used to facilitate this.

Attached is a completed Technical Review Request for Connection of Load. We would appreciate your earliest response to this Technical Review Request application, even if only with preliminary feedback.

We would like the opportunity to discuss the following prior to your technical feedback:

- Quantity and rating of 132kV supply;
- Temporary feeder arrangement at 11/22kV;
- Opportunity for connection to 132kV feeders;
- Connection arrangements within existing and proposed ZSs, (diverse busses etc);
- Diverse cable routes to the site;
- Program and timeframe for connection to the proposed site.

Yours sincerely,



Charlotte Ware
Electrical Engineer

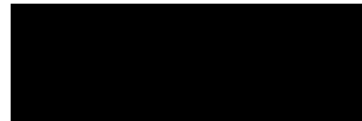

March 10, 2020

Confidential

Kevin Nuner
Endeavour Energy
490 Hoxton Park Rd
Hoxton Park NSW 2171
PO Box 811 Seven Hills 1730
Australia

Dear Mr. Nuner,

Re: Energy application for unaddressed location (approximately -33.835798, 150.778699 on Mamre Rd, NSW (the "Site"))

We would like to advise you that  has appointed Arup Australian Pty Ltd as its consultant for the purpose of submitting a power application at the Site. We would appreciate if you could assist Arup in the application.

Please let us know if you have any questions.

Thank you very much for your assistance.

Yours truly,

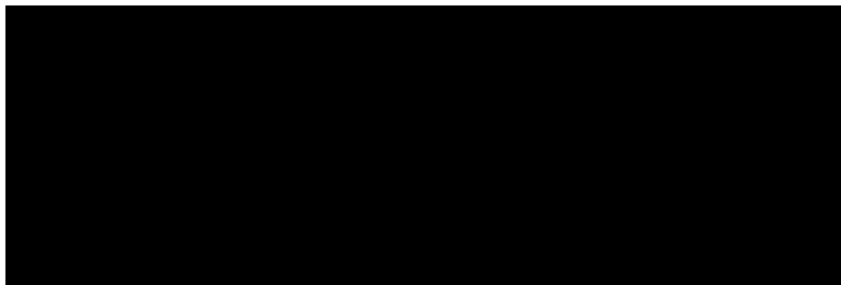

3/16/2020



27 April 2020

Endeavour Energy Ref: ENL3688 – 2014/02306/001

Arup Pty Ltd
151 Clarence Street
SYDNEY NSW 2000

Attention: Charlotte Ware

ENL3688 – Technical Review | [REDACTED] Data Centre, 757 Mamre Road, KEMPS CREEK

Endeavour Energy (Endeavour) has acknowledged your enquiry regarding the electricity supply for a potential [REDACTED] data centre development at the above location. Your enquiry has been registered under the above reference number. Please quote this reference number on all future correspondence.

Endeavour has been advised by Arup (consultant on behalf of [REDACTED]) that the data centre may require an ultimate load of 197MVA with anticipated load growth as shown in table 1 and table 2 below.

IT Load	144 MW
PUE	1.3
Total Load	187.2 MW
Power Factor	0.95
Total Load	197.05 MVA

Table 1 – ultimate site load details

Year	Site Load (MW) @ 3-9s	Site Load (MVA) @ 3-9s
2022 Q2	12.96	13.6
2023 Q3**	12.48	13.1
2024 Q3	24.96	26.3
2025 Q3	37.44	39.4
2026 Q3	49.92	52.5
2027 Q3	62.4	65.7
2028 Q3	74.88	78.8
2029 Q3	87.36	92.0
2030 Q3	99.84	105.1
2031 Q3	112.32	118.2
2032 Q3	124.8	131.4
2033 Q3	137.28	144.5
2034 Q3	149.76	157.6
2035 Q3	162.24	170.8
2036 Q3	174.72	183.9
2037 Q3	187.2	197.1

*PUE=1.30, pf=0.95

Table 2 – anticipated load growth

Development site details

The proposed data centre site is located approx. 6.5km from TransGrid's Bulk Supply Point (BSP) and 4.5km from Endeavour's Mamre Zone Substation (ZS). The supply voltage of Endeavour's transmission network in the area is 132kV. Refer to Figure 1 below for details.

It is to be noted that the subject site is located west of "Oakdale West Precinct" development where local public road(s) will be created through Oakdale West development which potentially will provide alternative routes for transmission feeder(s).



Figure 1 – site details & existing Endeavour's transmission network

Potential connection option to Endeavour's 132kV network

Endeavour has undertaken network analysis to supply ultimate load of 195MVA for the proposed [REDACTED] data centre at above location, considering final configuration of Endeavour's 132kV transmission network in area close to Sydney West BSP and Mamre ZS for N-1 security of supply. Given the recent discussions with [REDACTED] concerning customer's preference to avoid installation of back-up generators, the option of N-2 security of supply has also been incorporated into this assessment. The concept of supplying [REDACTED] data centre at 132kV for N-2 security of supply is shown in Figure 2 below.

Proposed [REDACTED] data centre may be supplied from Endeavour's 132kV network via a new Endeavour's 132kV feeder from Sydney West BSP (main supply) all the way to a new 132kV switching station at data centre site. The availability of spare 132kV Circuit Breaker (CB) or any associated works to allow new 132kV feeder connection at TransGrid's Sydney West BSP shall be investigated and consulted with TransGrid in conjunction with Endeavour. The new feeder will likely be underground, along indicative route highlighted in green as shown on Figure 3. It is anticipated that most of roads along that route will be in place by 2023/24, as part of Oakdale West development. This feeder route may, for the part of it, happen to be along the same roads as route of a future Endeavour's 132kV feeder backbone. Coordination

and design consideration shall be given when it comes to the detailed feasibility study or design.

A second 132kV feeder from Mamre ZS all the way to the switching station may be provided for N-1 back-up. A new 132kV CB at Mamre ZS will be required to allow the feeder connection. The new 132kV feeder will likely be underground, along indicative route highlighted in blue as shown on Figure 3. Easements over several private properties, which also have TransGrid's 330kV easement over them, will need to be negotiated by the developer.

Endeavour proposes to install a new 132kV Aerotropolis backbone feeder from Sydney West BSP to Bringelly ZS by FY2024, part of which is between South Erskine Park ZS and the Science Park ZS. To achieve N-2 security of supply, two 132kV underground feeders may be extended from the switching station at data centre site and cut in and out this backbone 132kV feeder, in section between future South Erskine Park ZS to Science Park ZS (at location close to intersection of Mamre Rd and Bakers Ln). Total of four 132kV underground feeders are unlikely to be accommodated within same public road (Mamre Rd), hence alternative route for N-2 feeder(s) may need to be considered.

If this section of the backbone feeder is overhead, tee off connection of [REDACTED] Data Centre via a third overhead feeder would be acceptable.

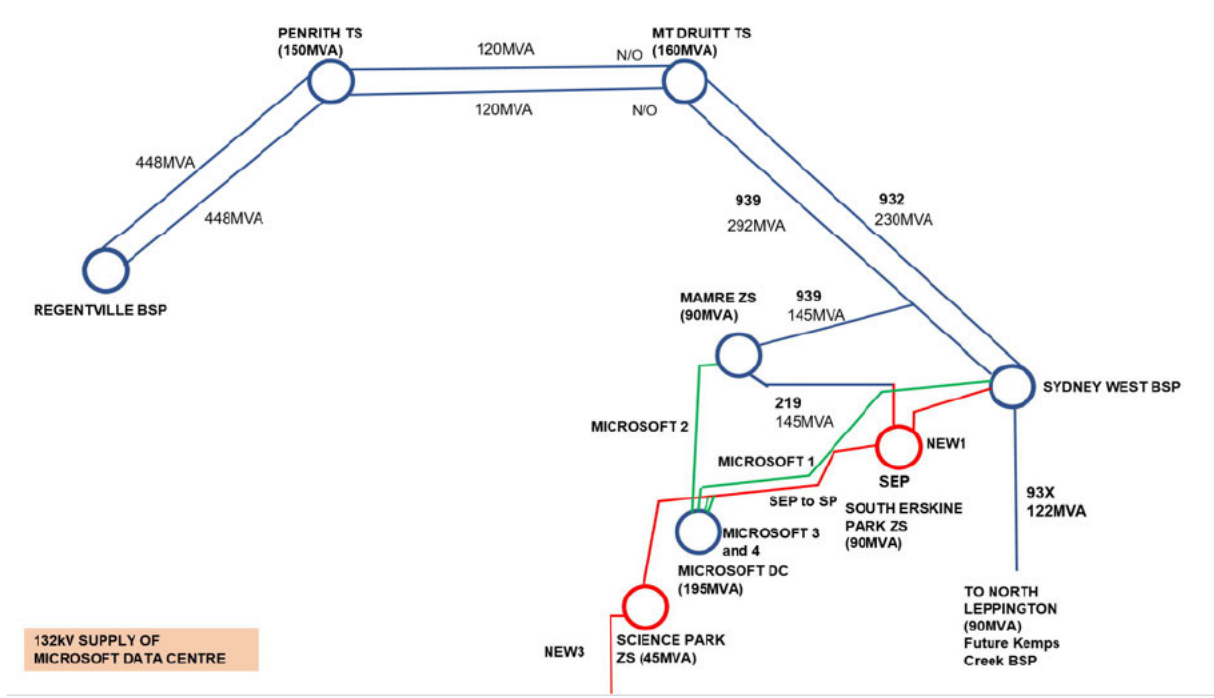

Legend for the above line diagram:
 Blue – Existing network
 Red – New network to be built by Endeavour Energy
 Green – New network to be built by the customer [REDACTED] Data Centre

Figure 2 – [REDACTED] data centre supply option (concept), 195MVA N-2

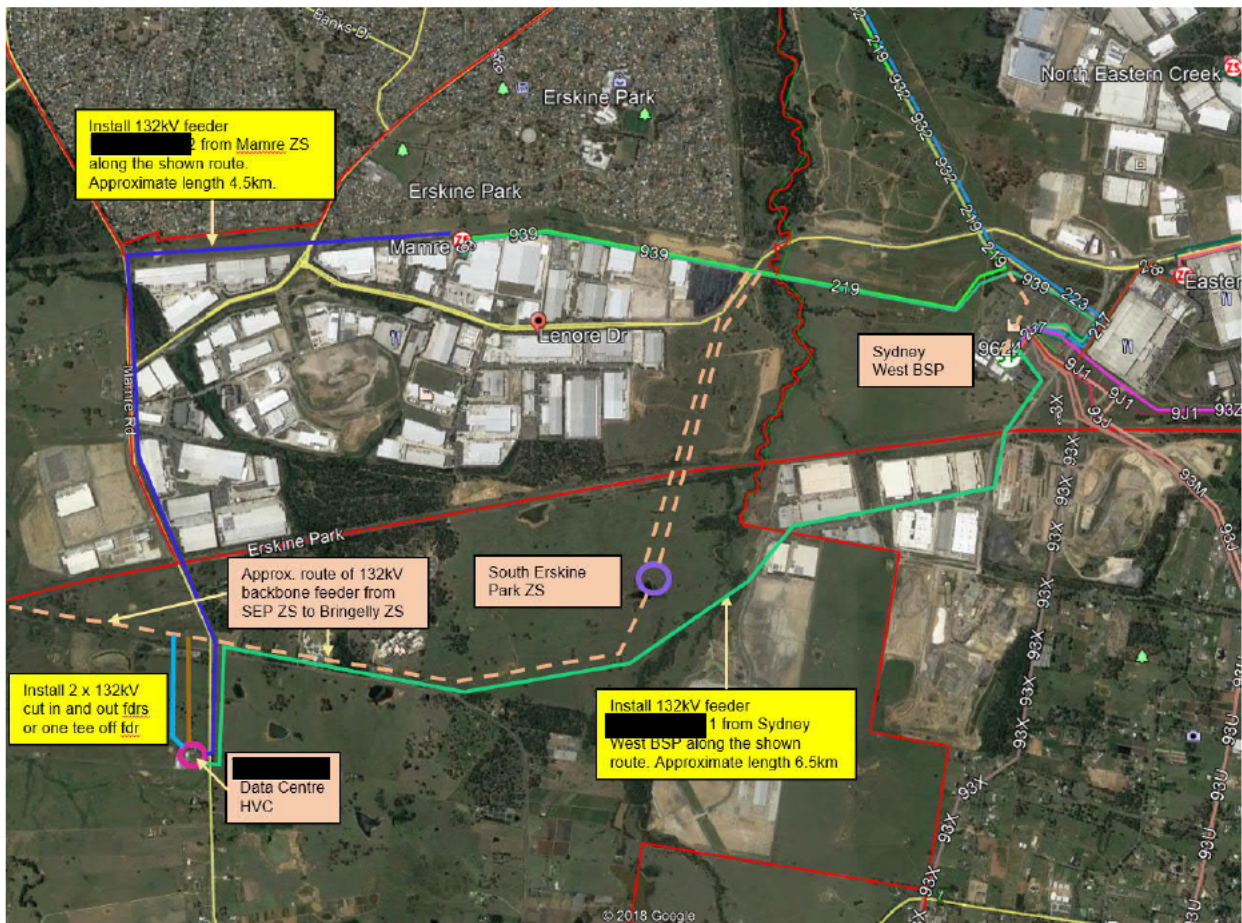

Figure 3 – potential 132kV feeder route

Interim 11/22kV supply options

Prior to establishing the 132kV connection assets for ultimate supply, 11kV temporary connection may be established from two dedicated 11kV CBs at Mamre ZS as shown in Figure 4. It may allow for load of up to 12MVA with N-1 security of supply, subject to the detailed feeder rating assessment. Each 11kV CB will need to be double cabled to provide higher rating of the feeder. The 11kV interim option out of Mamre ZS is not preferred by Endeavour and has higher implementation risks, as ducts and routes are congested; however, if this fits within the customer's time frame for connection, Endeavour may consider this option.

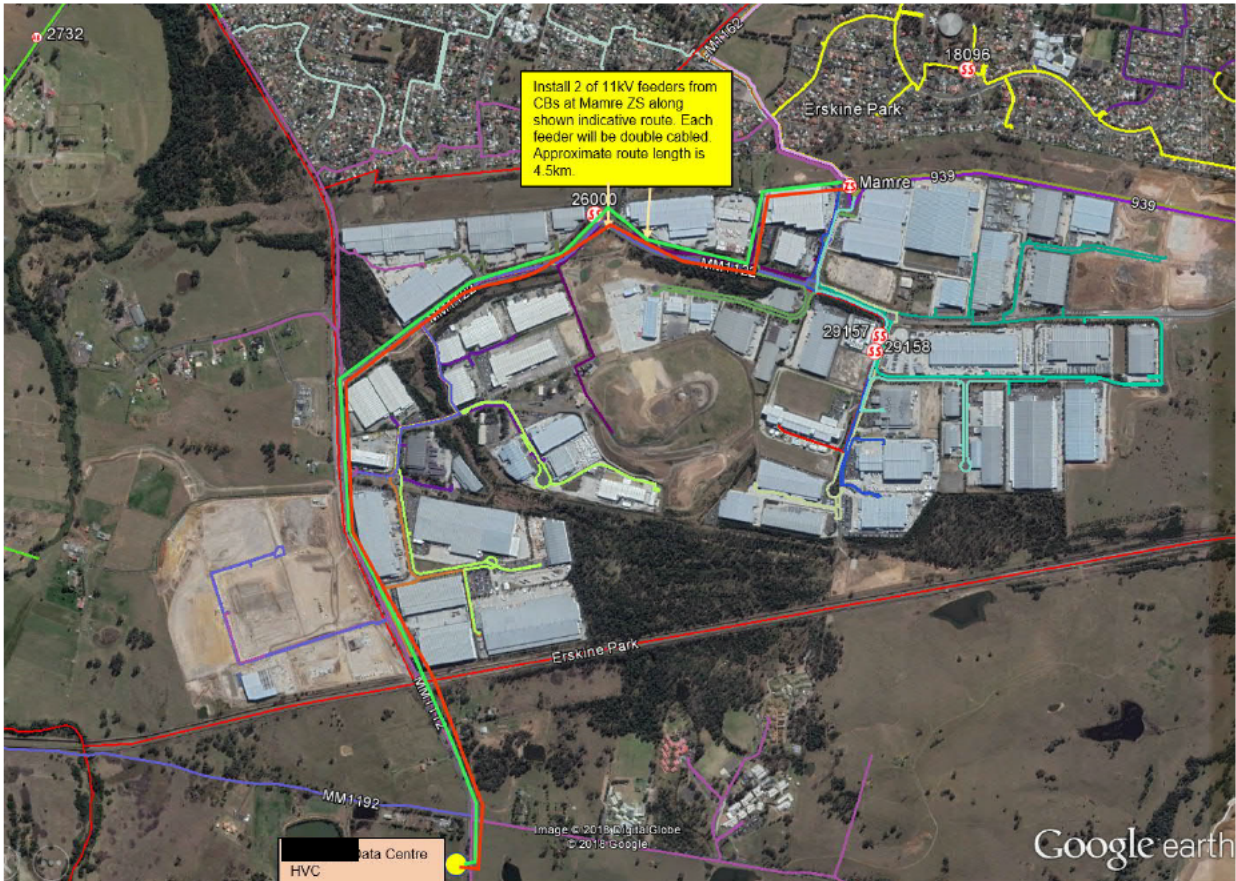

Figure 4 – Interim 11kV supply from Mamre ZS

22kV temporary connection can be established from Endeavour’s future South Erskine Park ZS via two dedicated 22kV CBs and single 22kV cables on each CB. This can provide at least 12MVA capacity at N-1 with two single cable feeders. Refer to Figure 5. This connection will not be available until 2023 when South Erskine Park ZS will be commissioned. However, this is Endeavour’s preferred option for interim supply.



Figure 5 – Interim 22kV supply from future South Erskine Park ZS

Please note that all feeder routes shown in above assessment are suggested or indicative only, customer shall engage the Accredited Service Provider (ASP) to undertake contestable design and select a feasible route with all relevant design and environmental considerations as well as coordination with Endeavour's proposed works in vicinity.

Hope above information and response assist for the meantime. It is to be noted that this advice provided is in response to an enquiry only and does not constitute a formal method of supply. A formal application for connection of load must be submitted to Endeavour and subsequent Connection Offer been made or design certified should Endeavour reserve capacity on the network.

Should you have any questions regarding your enquiry please contact the undersigned.

Yours faithfully,

J. Lei

Jonathan Lei
CONTESTABLE WORKS PROJECT MANAGER
Ph: 02 9853 7905
M: 0448173719
Email: Jonathan.Lei@endeavourenergy.com.au

9 September 2020

Endeavour Energy Ref: UCL10561– 2014/02306/001

ARUP
151 Clarence St
SYDNEY NSW 2000

Attention: Charlotte Ware

CONNECTION OFFER – STANDARD CONNECTION SERVICE

UCL10561– [REDACTED] Data Centre Development, 757 Mamre Road, KEMPS CREEK

Endeavour Energy (Endeavour) has received your application for connection of load for the proposed Data Centre by [REDACTED] requiring maximum demand of 175MVA at above address. Your application has been registered under the above reference number. Please quote this reference number on all future correspondence.

As advised in Endeavour's response to previous technical review request – ENL3688, the proposed data centre may be supplied from Endeavour's 132kV network via a new Endeavour's 132kV feeder (approx. 6.5km) from Sydney West Bulk Supply Point (BSP) to the data centre site and a second 132kV feeder from Endeavour's Mamre ZS to the data centre site (approx. 4.5km) for N-1 back-up. N-2 security of supply may also be achievable by extending two 132kV underground feeders from a switching station at data centre site and cutting in and out of Endeavour's proposed 132kV Aerotropolis backbone feeder, which originates from Sydney West BSP to Bringelly ZS, at location close to the intersection of Mamre Rd and Bakers Ln. Customer must confirm the required level of supply redundancy for the proposed data centre before the final connection arrangement can be developed.

To further develop the connection arrangements and associated connection requirements, detailed studies and investigations will need be carried out by Endeavour, including (but may not limit to):

- Investigate, in conjunction with TransGrid, the feasibility of establishing a spare 132kV Circuit Breaker (CB) or any associated works to allow new 132kV feeder connection at TransGrid's Sydney West BSP.
- Investigate the works associated with establishing a spare 132kV CB to allow the connection of a second 132kV feeder at Endeavour's Mamre ZS.
- Further planning study, network analysis and protection study for the proposed method of supply.
- Internal stakeholder consultations.

An application fee of \$38017.23 including GST has been determined. A payment advice form is attached and must be provided or referenced with the payment. Please note that no further network analysis works and investigations to develop the connection requirements will be undertaken until the application fee is paid.

Works within Endeavour Energy's transmission substation or zone substation to provide suitable connection point is generally constructed by Endeavour Energy (works within Sydney West BSP will be constructed by TransGrid), and the customer is generally responsible for the establishment of connection assets under the contestable works process. The final funding determination of the project will be confirmed in the Design Brief once the scope of the works is determined. It is to be noted that separate Project Definition(s) would need to be established

for mains, substation and switching station works if required. The cost and time to produce each Project Definition is in the order of \$9,000 for transmission mains and up to \$49,000 for transmission substation/switching station and may take 12 weeks to be produced.

Where Endeavour Energy's overhead or underground transmission mains are required to be established on private properties, suitable easement in favour of Endeavour Energy must be created. Where transmission switching station is required to be established on private properties, Endeavour Energy's required form of property tenure is freehold land, including access ways linking sites to public roads.

Since there is a need for a transmission network extension, a pre-qualified accredited service provider designer (ASP L3) must be engaged to progress the contestable design works. A list of pre-qualified ASPs is available at Endeavour Energy's website. A notice of advice form is attached which allows the ASP/3 to be nominated. There are additional fees for the contestable design and construction processes and the ASP L3 should be able to provide advice regarding the design and possibly the construction fees for contestable works.

Endeavour recommends that the following feasibility studies or option analysis are to be carried out by customer or its presentative/ASP in parallel with Endeavour's further network analysis and studies.

- New feeder route options from Sydney West BSP to the data centre site.

Note: this new 132kV feeder is likely to be underground and will traverse Oakdale West development by Goodman.

- New feeder route options from Mamre ZS to the data centre site.

Notes: this new 132kV feeder will likely be underground, originating from Mamre ZS west to Mamre Rd. Creation of easements over several private properties, which also have TransGrid's 330kV easement over them, will need to be negotiated by the developer with the property owners as well as TransGrid.

Due to the long lead time to establish 132kV connection assets and works, interim supply at lower voltages may be required prior to establishing 132kV connection. Interim supplies via new 22kV dedicated feeder(s) from Endeavour's South Erskine Park ZS (under construction) located within Oakdale West Precinct to the data centre site can be established. This connection will not be available until Q4 2022 when South Erskine Park ZS will be commissioned. Further review of the network capacity, method of supply, availability of the feeder route and easement requirements shall be undertaken to ascertain the connection requirements. Separate application for connection of load must be submitted to initiate the connection process, should customer consider establishing interim supply to the data centre site.

This connection offer is made in accordance with the Terms and Conditions of the Model Standing Offer for a Standard Connection Service available on Endeavour Energy's website. Should you have any enquiries regarding your application please contact the undersigned.

Yours faithfully,

J. Lei

Jonathan Lei
Contestable Works Project Manager
Ph: 02 9853 7905
Email: Jonathan.Lei@endeavourenergy.com.au

9 September 2020

Endeavour Energy Ref: UCL10561– 2014/02306/001

Endeavour Energy
PO Box 811
Seven Hills NSW 1730
cwadmin@endeavourenergy.com.au

Attention: Contestable Works Administrator

NOTICE OF ADVICE

**APPOINTMENT OF ACCREDITED DESIGNER FOR THE PROPOSED DEVELOPMENT AT:
LOT 22, DP 258414, 757 MAMRE ROAD, KEMPS CREEK**

*** Please complete and return when a Level 3 Service Provider has been nominated***

Please accept this letter as notification that I intend to proceed with the development described above. I own or am developing the land and works on the land, (and/or where relevant on public land). I intend to supply this development to Endeavour Energy requirements.

By signing this Notice of Advice I am accepting the Terms and Conditions of Endeavour Energy’s Model Standing Offer for a Standard Connection Service.

- Electricity Supply to Developments.

The Level 3 Service Provider appointed is:.....

The Fees will be Paid to Endeavour Energy by:

.....
Signature of Level 3 ASP

.....
Name of Level 3 ASP

.....
Signature of Applicant/ Applicant’s Representative

.....
Name of Applicant/ Applicant’s Representative

.....
Date

.....
Company Name

The signatory warrants that they are authorised to execute this Application.

Jonathan Lei
 Endeavour Energy
 PO Box 811
 Seven Hills
 NSW 1730

Arup, Level 5, Barrack Place
 151 Clarence St
 Sydney NSW 2000
 Australia
 t +61 2 9320 9077
 charlotte.ware@arup.com
 www.arup.com

16 September 2020

Dear Jonathan,

AZ3 - Kemps Creek – Temporary Supply

Arup have been appointed by [REDACTED] to carry out early investigation into power availability for a proposed data centre campus. The proposed site is at 757 Mamre Road, Kemps Creek, NSW 2179. The site area is marked in green and pink below:



The table below summarises the expected ultimate load for the site:

<i>Item</i>	Estimated Ultimate Load
<i>IT Equipment</i>	151.6 MVA
<i>Mechanical Equipment</i>	45.5 MVA
Total Load	197.1 MVA

The calculated load of 197.1MVA may vary based on final equipment selections and ongoing design development.

The table below outlines anticipated load growth over the number of years.

Year	Estimated site load (MW)	Estimated site load (MVA)
2022 Q2*	12.96	13.6
2023 Q3*	12.5	13.1
2024 Q3	25.0	26.3
2025 Q3	37.4	39.4

2026 Q3	49.9	52.5
2027 Q3	62.4	65.7
2028 Q3	74.9	78.8
2029 Q3	87.4	92.0
2030 Q3	99.8	105.1
2031 Q3	112.3	118.2
2032 Q3	124.8	131.4
2033 Q3	137.3	144.5
2034 Q3	149.8	157.6
2035 Q3	162.2	170.8
2036 Q3	174.7	183.9
2037 Q3	187.2	197.1

*Based on estimated timeline for 132kV supply, expected load will require temporary supply.

It is anticipated that an 11 or 22kV temporary supply will be required until the 132kV supply is available. This application relates to this temporary supply. Anticipated to supply a total load of 13.6MVA at N-1.

Switching Stations can be provided on the site boundary, subject to Endeavour Energy requirement, for termination of the Endeavour Energy feeders. The 11/22kV utility feeders will not be paralleled on the site. Standby generators will be provided downstream for emergency standby use only and are not intended to operate in parallel with the utility supplies at any time – suitable transfer switching equipment will be used to facilitate this.

Attached is a completed Application for Connection of Temporary Load. Noting that

We intend to have a preliminary discussion with Endeavour Energy and [REDACTED] on Wednesday 23rd 2020 to discuss the constraints surrounding the temporary supply and to better understand the following:

- Program and timeframe for the 132kV supply
- Supply options for the temporary supply
- Program and timeframe for the temporary supply
- Connection arrangements within existing and proposed ZSs, (diverse busses etc);
- Diverse cable routes to the site;

Yours sincerely,



Charlotte Ware
Electrical Engineer

Jonathan Lei
 Endeavour Energy
 PO Box 811
 Seven Hills
 NSW 1730

Arup, Level 5, Barrack Place
 151 Clarence St
 Sydney NSW 2000
 Australia
 t +61 2 9320 9077
 charlotte.ware@arup.com
 www.arup.com

16 September 2020

Dear Jonathan,

AZ3 - Kemps Creek – Temporary Supply

Arup have been appointed by ██████████ to carry out early investigation into power availability for a proposed data centre campus. The proposed site is at 757 Mamre Road, Kemps Creek, NSW 2179. The site area is marked in green and pink below:



The table below summarises the expected ultimate load for the site:

<i>Item</i>	Estimated Ultimate Load
<i>IT Equipment</i>	151.6 MVA
<i>Mechanical Equipment</i>	45.5 MVA
Total Load	197.1 MVA

The calculated load of 197.1MVA may vary based on final equipment selections and ongoing design development.

The table below outlines anticipated load growth over the number of years.

Year	Estimated site load (MW)	Estimated site load (MVA)
2022 Q2*	12.96	13.6
2023 Q3*	12.5	13.1
2024 Q3	25.0	26.3
2025 Q3	37.4	39.4

2026 Q3	49.9	52.5
2027 Q3	62.4	65.7
2028 Q3	74.9	78.8
2029 Q3	87.4	92.0
2030 Q3	99.8	105.1
2031 Q3	112.3	118.2
2032 Q3	124.8	131.4
2033 Q3	137.3	144.5
2034 Q3	149.8	157.6
2035 Q3	162.2	170.8
2036 Q3	174.7	183.9
2037 Q3	187.2	197.1

*Based on estimated timeline for 132kV supply, expected load will require temporary supply.

It is anticipated that an 11 or 22kV temporary supply will be required until the 132kV supply is available. This application relates to this temporary supply. Anticipated to supply a total load of 13.6MVA at N-1.

Switching Stations can be provided on the site boundary, subject to Endeavour Energy requirement, for termination of the Endeavour Energy feeders. The 11/22kV utility feeders will not be paralleled on the site. Standby generators will be provided downstream for emergency standby use only and are not intended to operate in parallel with the utility supplies at any time – suitable transfer switching equipment will be used to facilitate this.

Attached is a completed Application for Connection of Temporary Load. Noting that

We intend to have a preliminary discussion with Endeavour Energy and [REDACTED] on Wednesday 23rd 2020 to discuss the constraints surrounding the temporary supply and to better understand the following:

- Program and timeframe for the 132kV supply
- Supply options for the temporary supply
- Program and timeframe for the temporary supply
- Connection arrangements within existing and proposed ZSs, (diverse busses etc);
- Diverse cable routes to the site;

Yours sincerely,



Charlotte Ware
Electrical Engineer

21 September 2020

Endeavour Energy Ref: UCL10591– 2014/02306/001

ARUP
151 Clarence St
SYDNEY NSW 2000

Attention: Charlotte Ware

CONNECTION OFFER – STANDARD CONNECTION SERVICE

UCL10591– Interim Supply for [REDACTED] Data Centre at 757 Mamre Road, KEMPS CREEK

Endeavour Energy has received your application for the proposed development at the above location. Your application has been registered under the above reference number. Please quote this reference number on all future correspondence.

Your application is for the connection of 13.6MVA at Endeavour Energy's Medium Voltage (MV) distribution network with N-1 supply redundancy to provide interim supply for the proposed [REDACTED] Data Centre who is currently seeking permanent connection of total 197MVA at 132kV under Endeavour's CAP Reference UCL10561.

Based on desktop assessment, it is likely that the proposed load will be supplied from Endeavour Energy's South Erskine Park Zone Substation (SEPZS) which is currently under construction and will be commissioned in Q4 2022. SEPZS is located within Oakdale West Precinct which is approx. 3.5km from the development site. It is envisaged that, after SEPZS is commissioned, the supply at 22kV with full redundancy can be made available to the demarcation point of the proposed High Voltage Customer (HVC) site via two 22kV underground feeders. Two 22kV switching stations shall be established within the boundary of the development property as connection points for customer's HV incoming consumer mains. Suitable easement is required to be created for Endeavour Energy's 22kV switching stations. The method of installation of the underground cable/s between SEPZS and the switching stations will determine feeder rating, therefore a detailed electrical design is required to confirm that the required capacity can be delivered to the site.

If customer decides to proceed with interim 22kV supply from SEPZS, Endeavour Energy will investigate and nominate suitable feeder connection circuit breaker (CB) at SEPZS in association with customer's connection works. Works associated with making connection point CB available within Zone Substations are generally funded and constructed by Endeavour Energy.

In order to further develop the connection requirements for the proposed connection, an application fee of \$16,146.83 including GST has been determined. A Payment Advice form is attached and must be presented with the payment. Please note that no further network analysis works will be undertaken until the application fee is paid.

After payment of the application fee is received by Network Connections, a detailed connection requirements letter is usually developed and issued within 4- 6 weeks, however if increased time is required to address complex issues then you will be advised of the status of the application along with an expected delivery date for the connection requirements letter.

Since there is a need for a network extension, an accredited service provider designer (ASP/3) must be engaged to progress the contestable design works. A notice of advice form is attached which allows the ASP/3 to be nominated. There are additional fees for the contestable design and construction processes and the ASP/3 should be able to provide advice regarding the design and possibly the construction fees. It is to note that majority of the public roads for cable routes from SEPZS within Oakdale West Precinct to Bakers Lane are unformed at this stage, investigations are required to ascertain the feeder route to align with the planning requirements and to confirm the property requirements associated with the connection works.

A list of the Accredited Service Providers is available at the NSW Trade and Investment website: <https://energysaver.nsw.gov.au/households/you-and-energy-providers/installing-or-altering-your-electricity-service> or can be obtained via phone 13 77 88.

Should you have any enquiries regarding your application please contact the undersigned.

Yours faithfully,

J. Lei

Jonathan Lei
Contestable Works Project Manager
Ph: 02 9853 7905
Email: Jonathan.Lei@endeavourenergy.com.au

21 September 2020

Endeavour Energy Ref: UCL10591– 2014/02306/001

Endeavour Energy
PO Box 811
Seven Hills NSW 1730
cwadmin@endeavourenergy.com.au

Attention: Contestable Works Administrator

NOTICE OF ADVICE

**APPOINTMENT OF ACCREDITED DESIGNER FOR THE PROPOSED DEVELOPMENT AT:
LOT 22, DP 258414, 757 MAMRE ROAD, KEMPS CREEK**

*** Please complete and return when a Level 3 Service Provider has been nominated***

Please accept this letter as notification that I intend to proceed with the development described above. I own or am developing the land and works on the land, (and/or where relevant on public land). I intend to supply this development to Endeavour Energy requirements.

By signing this Notice of Advice I am accepting the Terms and Conditions of Endeavour Energy's Model Standing Offer for a Standard Connection Service.

- Electricity Supply to Developments.

The Level 3 Service Provider appointed is:.....

The Fees will be Paid to Endeavour Energy by:

.....
Signature of Level 3 ASP

.....
Name of Level 3 ASP

.....
Signature of Applicant/ Applicant's Representative

.....
Name of Applicant/ Applicant's Representative

.....
Date

.....
Company Name

The signatory warrants that they are authorised to execute this Application.

16 December 2020

Endeavour Energy Ref: UCL10591– 2014/02306/001

ARUP
151 Clarence St
SYDNEY NSW 2000

CONNECTION OFFER – SUPPLY OFFER

Dear Charlotte,

UCL10591–Interim Supply for [REDACTED] Data Centre at 757 Mamre Road, KEMPS CREEK

Following your application for connection of load and receipt of the payment of application fees, Endeavour Energy (Endeavour) has assessed your application for connecting 13.6MVA load with N-1 supply redundancy for the interim supply to the proposed [REDACTED] Data Centre at above address, and I can confirm that Endeavour can offer capacity and connection from proposed Southern Erskine Park Zone Substation (SEPkZS) located within Oakdale West Precinct. Endeavour has publicly committed to October 2022 for the commissioning of SEPkZS that is currently in construction and is targeting an earlier completion by 3-4 months. As SEPkZS project further progresses, Endeavour may be able to firm up the commissioning scenarios.

The purpose, in part, of this Supply Offer letter is to provide information and advice regarding the connection requirements associated with network connection assets, connection process and the customer's installation requirements that must be achieved prior to Endeavour approving the connections.

Connection Customer is required to establish two dedicated underground distribution feeders from SEPkZS to the development site to make full redundancy supply available. The connection voltage is at 22kV. Two Endeavour's distribution switching stations shall be established within the boundary of the development property as connection points for customer's HV incoming consumer mains. The method of installation of the underground cable(s) between SEPkZS and the switching stations will determine feeder rating, therefore a detailed electrical design by customer's nominated Level 3 Accredited Service Provider (ASP) is required to confirm that the required capacity can be delivered to the site. Endeavour's desktop assessment indicates that up to 10.4MVA may be achieved via a single 22kV 240mm² CU XLPE cable which is the largest distribution feeder cable used in 22kV network as per Endeavour's network standards.

Potential feeder route is likely to follow future Southern Link Road starting from SEPkZS located on "Services Lot" as shown in Figure 1 below, and then to Bakers Lane, west along Bakers Lane and turn south into Mamre Road. At this stage, there is limited information about Southern Link Road development including its timing. The developer of Southern Link Road shall be contacted for additional information and potential design coordination.

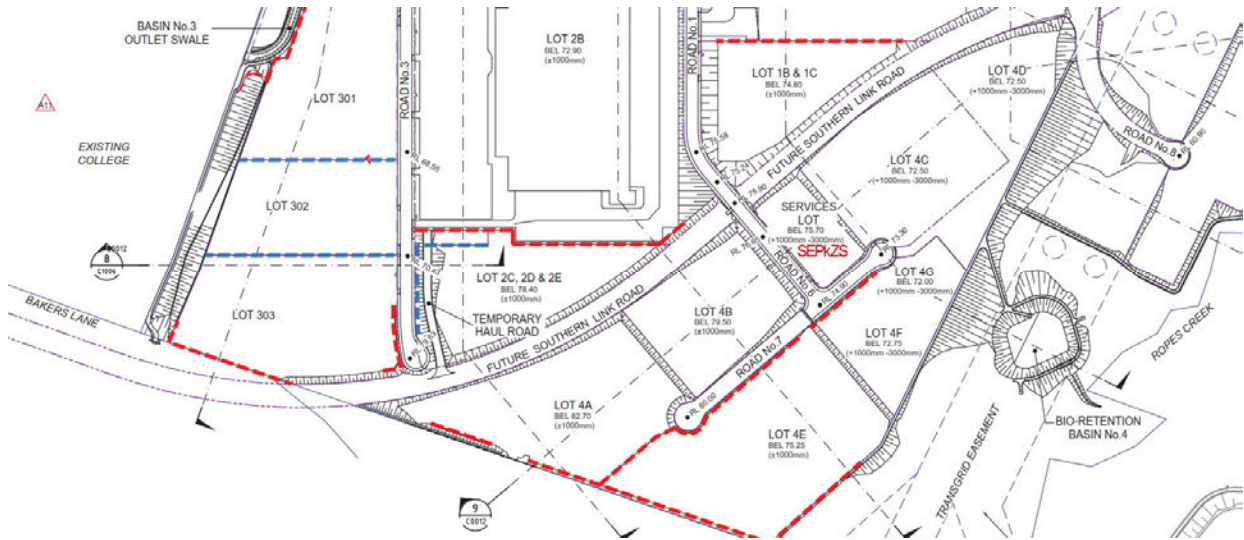

Figure 1 – Future Southern Link Road

Endeavour has already acquired an easement for services over future Southern Link Road (as shown in yellow in Figure 2 below) from SEPkZS to the southern boundary of Oakdale West Precinct development (Lot 100). Endeavour will also acquire an easement over the land between Lot 100 and Aldington Road to provide a corridor for future feeders between SEPkZS and Bakers Lane/Aldington Road. Further update regarding this easement acquisition can be provided as the project progresses.



Figure 2 – Endeavour's existing easement

Although the indicative feeder route and info is provided, the Level 3 ASP or Connection Customer will be responsible for obtaining feeder routes and managing associated project risks.

Design and construction of the proposed connection assets must be funded by the customer and gifted to Endeavour under the contestable works framework, this process is documented in Endeavour's Model Standing Offer for a Standard Connection Service. The customer must

engage Level 3 and Level 1 Accredited Service Providers (ASP) to perform the works to establish connection assets.

In order to proceed with the design and construction of above works, a detailed method of supply (MOS) showing the proposed switching stations locations, feeder route and cabling works shall be investigated and provided by the nominated Level 3 ASP. Ancillary network service fees, such as design certification fees, design information fees would apply once the proposed MOS is agreed and design brief is issued.

After the connection works are completed, approval must be issued before the Customer's Installation can be connected to the 22kV connection points at Endeavour's switching stations. Remainder of this letter details the requirements which must be achieved prior to approving connection of Customer's Installation and provides information regarding ongoing operation of Customer's Installation.

Customer's Installation

The customer's installation will originate at the Connection Point(s), which will be the load side terminals of an HV switch within Endeavour's switching stations located on the customer's lot. This switch will provide isolation between the Customer's installation and Endeavour Energy's network.

The customer's installation, including all additions and modifications, must be installed in accordance with AS/NZS 3000, Service and Installation Rules of NSW, and other relevant Australian Industry Standards. It is noted that the customer's installation is to conform with AS/NZS 2067 – "Substations and high voltage installations exceeding 1kV a.c", in particular the requirements regarding earthing coordination. **A proposed Single Line Diagram for the customer's installation must be submitted to Endeavour for review and approval.** It is recommended that no construction of the Customer's main switchboard or the high voltage installation commence prior to Endeavour's review of the single line diagram. The single line diagram must include reference to the connection point to Endeavour network, the customer's meter transformers and incoming protection device.

It must be noted that supply will not be made available until the customer's high voltage installation has been inspected by Endeavour's Customer Installation section. A Certificate of Compliance for Electrical Works (CCEW), high voltage test reports and any other relevant documentation will be required. Arrangements for this inspection can be made with Endeavour's Customer Installations section via email inspection@endeavourenergy.com.au. This office is to be notified at least two (2) weeks prior to the desired commissioning date.

Power Factor

Power Factor is to meet Service and Installation Rules of NSW requirements. These require a minimum 0.9 lagging Power Factor in accordance with rule 7.5.11 'Power Factor Correction'.

If, following connection of this installation, the site power factor does not meet the requirements, it must be improved by connection of power factor correction units within the timeframe set at the time the improvement works are determined.

Fault Level

The prospective maximum short circuit fault level at 22kV Connection Points is 13.1kA for 1 second. In accordance with Section 7.4.4 of Service & Installation Rules of NSW, the 22kV customer owned equipment upstream of the customer's incoming control and protection device (inclusive) must be capable of withstanding this fault level.

On request, I can be contacted regarding normal operating mode phase to phase and phase to earth fault levels to enable the customer or their electrical consultant to prepare their protection study and earthing design.

Operational Arrangements

The installation is registered as a high voltage customer installation, and the customer is responsible for the installation, operation and maintenance of the electrical assets and system within the site, including transformers and switchgear. Prior to connection of the supply, it will be necessary to contact Endeavour Energy's Network Security Manager, Mr John Pang; his direct number is (02) 9831 9054, for the preparation of a High Voltage Operating and Maintenance Protocol between Endeavour and the Customer. This contact is to confirm the division of responsibility and operational and emergency contacts required for the Protocol as well as any other site-specific conditions.

Protection Characteristics

The protection settings of the control and protection device in the Customer's incoming HV supply must grade with those of the Endeavour network.

Please provide details of customer's proposed incoming protection settings to enable Endeavour's protection engineer to review the designed grading separation and protection scheme. You can refer to Service & Installation Rules of NSW section 7 Attachment B for information required by electricity distributor for new or altered HV customer installations. Please allow at least 8 weeks prior to the proposed commissioning date of the customer's installation for protection review and any setting changes.

Revenue Metering

The Customer is responsible for the provision of metering on the incoming supply, therefore the Customer must obtain confirmation from their Electricity retailer the type of metering required for the installation, they must confirm if Type 3 or Type 2 metering is to be installed. The metering Type is dependent on the total annual energy consumption for a connection and will have a material impact on the main switchboard design, in particular the metering transformers.

Once the metering Type is confirmed, the appointed Metering Provider, typically selected by their Retailer, must confirm the proposed metering is in conformity with Chapter 7 – "Metering" of the National Electricity Rules (NER). This confirmation must include the Meter Provider's review of the proposed metering installation including metering transformers and must confirm that the appropriate error, type and accuracy tests have been performed as required in the NER. Confirmation must be made in writing from the appointed Meter Provider. **This confirmation must be directed to my attention and must be received prior to commissioning of the customers high voltage installation.** It is also noted that metering transformer test certificates must be provided to Endeavour's Customer Installation section as part of the documentation during the installation inspect and prior to connection.

Quality of Supply Issues

The voltage regulation and harmonic content resulting from the load being connected to the Endeavour network must not affect the supply of adjacent customers. Therefore, compliance is required to criteria set in the following documentation:

AS/NZS 61000 Series;

- Part 3.2 relates to Harmonic Currents
- Parts 3.3 and 3.5 relate to Voltage Fluctuations and Flicker

- Parts 3.6 and 3.7 relates to Assessment of Emission Limits for “Distorting” and “Fluctuating” loads in MV and HV power systems.

Endeavour will set parameters outside of these documents in relation to the equipment being connected as part of the installation, therefore Endeavour will provide flicker and harmonic allocations consistent with the expected total load of the site.

Costings

The total project cost is to be funded by the customer in accordance with the Model Standing Offer for a Standard Connection Service; approvals, environmental assessments, agreements and legal arrangements are the Customer’s responsibility. The final funding determination will be confirmed in the design brief.

AER approved fees associated with Chargeable Connection Services (also known as customer funded non-contestable works) are listed in Endeavour’s Network Price List as Ancillary Network Services. This may cover works to be carried out by Endeavour within zone substation and transmission substations, such as cable termination, protection setting changes, zone substation access and supervisions etc.

Validity

The details of this Connection Requirements are valid for three months from the date of issue.

This connection offer is made in accordance with the Terms and Conditions of the Model Standing Offer for a Standard Connection Service available on Endeavour’s website.

I will continue to liaise with you as the Contestable Project Manager for Network Connections Branch. Should you have any enquiries regarding your application please do not hesitate to contact me.

Yours faithfully,

J. Lei

Jonathan Lei
Contestable Works Project Manager
Ph: 02 9853 7905
Email: Jonathan.Lei@endeavourenergy.com.au

16 December 2020

Endeavour Energy Ref: UCL10591– 2014/02306/001

Endeavour Energy
PO Box 811
Seven Hills NSW 1730
cwadmin@endeavourenergy.com.au

Attention: Contestable Works Administrator

NOTICE OF ADVICE

**APPOINTMENT OF ACCREDITED DESIGNER FOR THE PROPOSED DEVELOPMENT AT:
LOT 22, DP 258414, 757 MAMRE ROAD, KEMPS CREEK**

*** Please complete and return when a Level 3 Service Provider has been nominated***

Please accept this letter as notification that I intend to proceed with the development described above. I own or am developing the land and works on the land, (and/or where relevant on public land). I intend to supply this development to Endeavour Energy requirements.

By signing this Notice of Advice I am accepting the Terms and Conditions of Endeavour Energy’s Model Standing Offer for a Standard Connection Service.

- Electricity Supply to Developments.

The Level 3 Service Provider appointed is:.....

The Fees will be Paid to Endeavour Energy by:

.....
Signature of Level 3 ASP

.....
Name of Level 3 ASP

.....
Signature of Applicant/ Applicant's Representative

.....
Name of Applicant/ Applicant's Representative

.....
Date

.....
Company Name

The signatory warrants that they are authorised to execute this Application.

21 December 2020

Endeavour Energy Ref: UCL10591– 2014/02306/001

ARUP
151 Clarence St
SYDNEY NSW 2000

Attention: Charlotte Ware

CONNECTION OFFER – SUPPLY OFFER (ADDENDUM)

UCL10591–Interim Supply for [REDACTED] Data Centre at 757 Mamre Road, KEMPS CREEK

This letter provides additional information for the Connection Offer issued on the 16^h Dec for [REDACTED] Data Centre interim supply and offers capacity and supply arrangement as alternate options, considering the possible availability of the feeder route/ducts at the time of commissioning of South Erskine Park Zone Substation (SEPkZS).

Endeavour Energy (Endeavour) has initiated internal project (HVN04817) to install TYPE-28 ducts (2 x 50mm ducts + 8 x 125mm ducts) along the northern side of the (unbuilt) Southern Link Rd from SEPkZS to Bakers Lane / Aldington Rd as part to establish future “Bakers Lane” and “Aldington Rd” feeders. Refer to Figure 1 for indicative feeder duct route. These ducts will cater for six (6) 22kV single cable feeders for development in the area that Endeavour had planned or committed to its supply arrangement. This leaves two (2) spare 125mm ducts remaining through this critical part of the potential feeder route for data centre interim supply feeder between SEPkZS and development property.

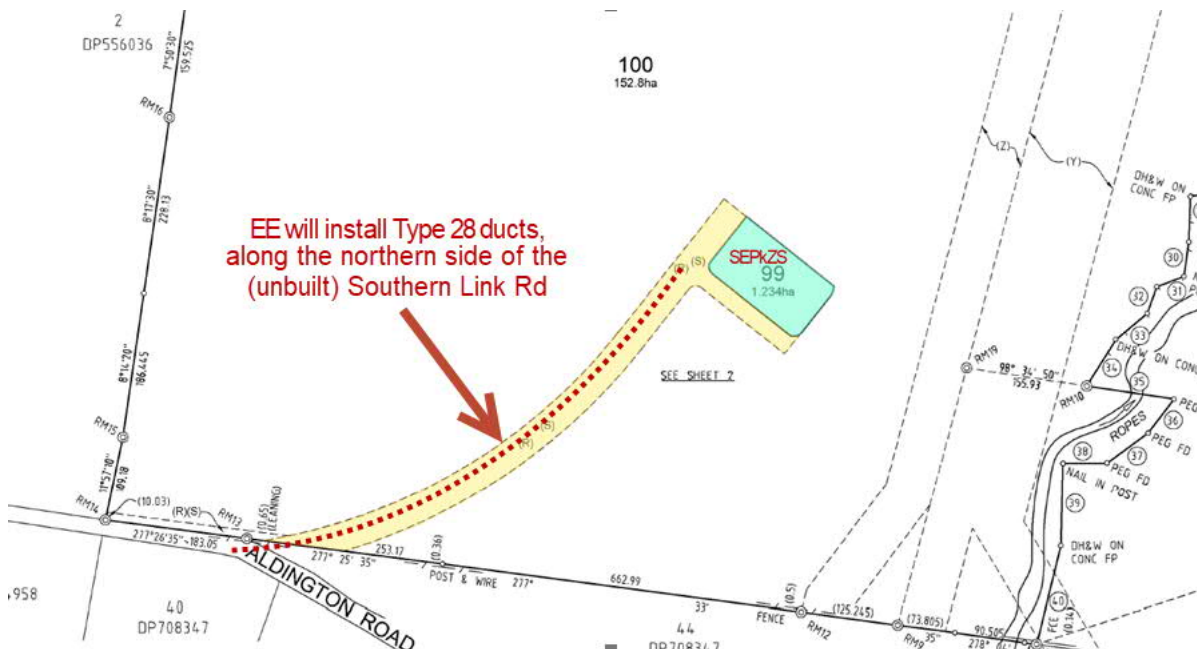

Figure 1

[REDACTED] Data Centre has requested 13.6MVA (N-1) interim supply until their 132kV supply solution is built and commissioned. This potentially requires two twin-cabled 240Cu XLPE 22kV feeders needing four (4) ducts.

The following interim supply options may be considered by [REDACTED] Data Centre potentially utilising the two spare ducts installed under Endeavour's project HVN04817:

OPTION 1:

One (1) twin-cabled feeder to provide 13.6MVA at 'N' supply

OPTION 2:

Two (2) single-cabled feeders to provide 10MVA at full 'N-1' supply or 13.6MVA with partial "N-1" supply (MS-Data can still draw 13.6MVA, with 6.8MVA per feeder with OPEN customer bus-section to avoid paralleling of Endeavour's zone substation busbar, but reduced to 10MVA on outage of any one feeder).

It is noted that Endeavour's Project HVN04817 will occur over two-year period with commissioning of new feeders expected in Q4 2022. These ducts may become available by Q1 2022, however more accurate update can be provided as project progresses closer to the commissioning date.

Should connection customer consider one of above supply options, a proposed method of supply can be submitted by nominated Level 3 Accredited Service Provider (ASP) confirming the details of the proposed works.

Should you have any enquiries regarding your application please do not hesitate to contact me.

Yours faithfully,

J. Lei

Jonathan Lei

Contestable Works Project Manager

Ph: 02 9853 7905

Email: Jonathan.Lei@endeavourenergy.com.au

21 December 2020

Endeavour Energy Ref: UCL10561– 2014/02306/001

ARUP
 151 Clarence St
 SYDNEY NSW 2000

Attention: Charlotte Ware

CONNECTION OFFER – SUPPLY OFFER

UCL10561 – Connection of 197 MVA data centre load at 757 Mamre Road, KEMPS CREEK

Thank you for submitting the application for permanent connection of a proposed data centre at the above address. The application identifies an ultimate load of 197MVA and this Connection Offer is to advise Endeavour Energy’s (Endeavour) connection arrangement to supply the ultimate load while also assisting the appointed Level 3 Accredited Service Provider (ASP) and installation consultants to develop the most efficient solution to meet the Connection Customer’s (Customer) need in accordance with Endeavour’s standards and the Model Standing Offer for a Standard Connection Service (MSO).

The information provided identifies that the initial supply is required in the second quarter of 2022 with an initial 22kV supply to support the development’s growth up to approximately 13.6MVA to be constructed under Endeavour project reference UCL10591, and transition to 132kV supply replacing the initial 22kV supplies in the third quarter of 2024.

Endeavour has assessed the application and notes the Customer’s requirement for fully redundant supply, therefore this Connection Offer is for the Customer to establish two new 132kV feeders rated for the Customer’s ultimate supply requirement and are to be gifted to Endeavour to own, operate and maintain under the NSW Contestable Works framework.

As per Endeavour’s previous advice under Technical Review Request reference ENL3688, one 132kV feeder will originate at Endeavour’s Mamre Zone Substation (MZS) and the second directly from Transgrid’s Sydney West Bulk Supply Point (SWBSP), see Figure 1 for these locations. It is envisaged that each Endeavour 132kV feeder will terminate at the Customer’s 132kV substation, although the exact feeder Connection Points will be subject to the Customer’s substation design and must be agreed in principle by Endeavour to progress to the next stage of this project.



Figure 1

Works to establish the new Endeavour 132kV feeders, including Endeavour feeder secondary systems at the Customer's substation is deemed Contestable Works and must be designed, constructed and funded by the Customer. Ownership and operation of the 132kV feeders including feeder secondary systems will be transferred to Endeavour on acceptance in accordance with the MSO. The Customer must engage Level 3 (Designer) and Level 1 (Constructor) Accredited Service Providers (ASP) prequalified by Endeavour to design and construct 132kV underground and substation works (feeder secondary only) associated with this project.

Mamre zone substation currently has a spare 132kV feeder bay however new feeder connection assets are required to allow connection of a new 132kV feeder, see Figure 2. Works to establish 132kV feeder connection assets at Mamre zone substation are to be funded by Endeavour and will be coordinated with new feeder works by the Customer's ASP's.

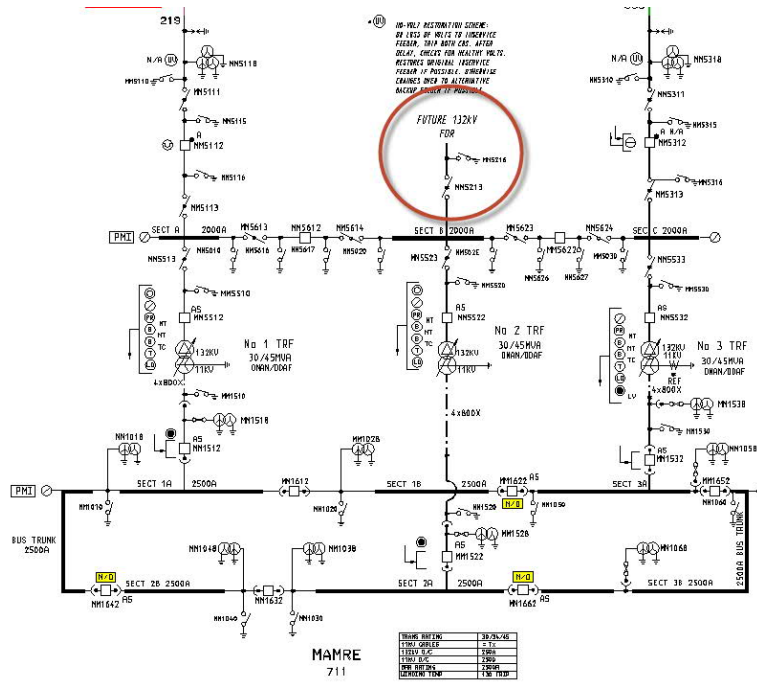

Figure 2

Works to establish feeder connection assets at SWBSP are subject to available feeder connection bay options. Transgrid must undertake these connection works within SWBSP and it is envisaged that the Customer will need to fund Transgrid works expected to be in the order of \$2,500,000 subject to detailed studies by Transgrid. Endeavour will continue to coordinate with Transgrid for detailed studies of feeder connection requirements, costs and timing in parallel with Endeavour's network augmentation work.

Works required to establish feeder connection assets within Mamre zone substation and SWBSP are to be coordinated with the Customer's nominated ASP's to ensure feeder connection points are made available, therefore the Customer must provide reasonable design and construction programme consistent with the proposed 2024 energisation date for the 132kV supply.

It is expected that the new 132kV feeders will terminate into the Customer's 132kV substation, however the exact location is dependent on the Customer's substation type and layout and will require easements in Endeavour's favour prior to initiating construction works to install proposed assets for Endeavour ownership. For an indoor type substation, Endeavour has contemplated the Customer's primary Connection Points to be at the incoming terminals of the Customer's 132kV GIS switchgear; alternatively, for an outdoor air insulated substation, this may be at the Endeavour cable sealing end stands or line side terminals at an overhead substation gantry.

For secondary Connection Points associated with Endeavour's feeder protection and communications systems, the Customer will be required to provide an Endeavour Protection &

Control room approximately five (5) metres by five (5) metres within the Customer's site. This room may be integrated into the Customer's substation building although ownership of this room is not to be transferred to Endeavour and appropriate easements to Endeavour standard MDI0044 and 24-hour unrestricted personnel and right of access will be required. The above arrangement precludes the need for the Customer to establish an Endeavour owned 132kV switching station as connection assets on the Customer's property.

The Customer's next step is to obtain the services of a Prequalified Level 3 ASP to prepare and provide a draft electrical design and submit to Endeavour as a Proposed Method of Supply. As noted above, the appointed Level 3 ASP must be pre-qualified by Endeavour to carry out transmission underground and substation design works, a list of pre-qualified ASP's is available on Endeavour's website or can be provided on request. To accept this Offer, please complete the enclosed Notice of Advice form and obtain your Prequalified Level 3 ASP signature on the form prior to returning it to Endeavour.

Once a Proposed Method of Supply is agreed, Endeavour can initiate preparation of a Project Definition (PD) which is a detailed scoping document that will form part of Endeavour's Design Brief to the Level 3 ASP and Endeavour's internal staff for the design, construction and commissioning works, including the Customer's primary equipment requirements and secondary systems coordination. The PD will define Contestable and Non-contestable works at Mamre zone substation, SWBSP and the Customer's substation. The PD will identify estimate of costs associated with Customer funded non-contestable works including protection, control, testing and commissioning works. Preparation of the PD will take minimum 12 weeks costing \$25,199.80 (including GST) and the Customer must fund the preparation of the PD therefore a Payment Advice is attached to this Connection Offer. If the customer accepts this Offer and can confirm the proposed Customer substation concept without nominating a Prequalified Level 3 ASP, Endeavour can initiate preparation of the PD once the fee is paid.

It is noted that Transgrid will also undertake scoping study similar to Endeavour's PD for the feeder bay works at SWBSP, Transgrid may require Endeavour to fund their initial scoping costs via a Services Agreement. This cost will likely be in the order of \$50,000 and Endeavour will pass this cost onto the Customer. The output of the Services Agreement will identify detailed estimate costs and timing for delivery. Endeavour will further advise Transgrid's requirements as the project progresses.

Once the 132kV connection works are completed, it is expected that the Customer's site will be supplied at both 22kV and 132kV for a short period while the Customer's high voltage installation transitions to 132kV. This transition is to be undertaken within three (3) months of the 132kV supply commissioning, and within this period, a separate asset removal project must be initiated by the Customer or their representatives to remove redundant 22kV assets. To ensure an asset removal project is initiated at the end of this project, a construction bond of \$50,000 will be held until construction of the asset removal project is initiated. The scope of works for the asset removal project is subject to the final Design Brief however may require the 22kV switching stations to remain in situ including easements on the Customer's property.

Consistent with Endeavour's Connection Policy, Endeavour may require the Customer to provide a Guarantee of Revenue (GoR) for Endeavour funded connection works deemed dedicated to the Customer. It is initially deemed low risk that Endeavour may not earn estimated incremental revenue from the construction works, however prior to commissioning, Endeavour will review the minimum capacity required to avoid GoR and hence may enter into an agreement with the Customer.

Endeavour must grant approval prior to connection and subsequent commissioning of Endeavour's network assets to the Customer's high voltage installation. The remainder of this Connection Offer details the connection requirements which must be achieved prior to approving connection and provides information regarding the ongoing operation of the Customer's installation.

Customer's Installation

The Customer's installation will originate at the Connection Points defined as the load side terminals where Endeavour's 132kV feeders connect to the Customer's 132kV substation. Secondary connection points will be where the Customer's secondary systems are integrated into Endeavour's feeder Protection and Control room as mentioned earlier. The Customer's installation must be designed and constructed in accordance with AS2067, AS3000, Service and Installation Rules of NSW, and other relevant Australian Industry Standards.

It must be noted that supply will not be made available until the Customer's 132kV Installation has been inspected by Endeavour's Customer Installation Section. Certificate of Compliance for Electrical Works (CCEW), high voltage test reports and any other relevant documentation must be submitted prior to the initial inspection. Arrangements for this inspection can be made with Endeavour's Customer Installations Section no later than four (4) weeks prior to the Customer's proposed commissioning date. Inspections must be booked two weeks prior to the required inspection date via the following email Inspection@endeavourenergy.com.au.

Single Line Diagram

The proposed Single Line Diagram (SLD) for the Customer's installation must be submitted for review. It is recommended that construction of the Customer's installation does not commence prior to Endeavour's review of the SLD. The SLD must include reference to Endeavour 132kV feeder, 132kV connection points, incoming control and protection devices, proposed line side earth switches, location and details of metering transformers, proposed protection schemes and bus sections (if applicable). Endeavour will require proposed SLD's of all voltages including location of proposed UPS and generation systems including transition methodology.

Endeavour does not allow customers to parallel supplies as this creates operational risks and can trigger operation of Endeavour's protection schemes. Paralleling of the incoming supplies is not allowed at any voltage unless under the direct control of Endeavour's System Operators.

Please ensure SLD's of the Customer's installation extending to all voltage levels is provided which include any generation facilities, and automatic or manual paralleling facilities, along with any proposed engineering or operational controls, intended to inhibit inadvertent paralleling of incoming supplies at any voltage level.

Fault Level

In conformity with Clause 7.4.4 of the Service and Installation Rules of NSW and Endeavour policy, the prospective fault level at the Connection Point is 40kA for 1 second. The Customer's equipment up to, and including, the incoming protective device must meet this minimum fault level.

Protection Characteristics

The Customer's incoming protection device will form part of Endeavour's protection scheme for each of the Endeavour 132kV feeders.

A Protection Concept & Design Agreement (PCDA) will need to be drafted to ensure coordination of Endeavour's feeder differential protection schemes and the Customer's incoming protection device. As part of the PCDA Endeavour will also review and agree on the Customer's 132kV installation protection for back up protection requirements such as Cbfail, relay redundancy to ensure Endeavour maintains system security obligations under the National Electricity Rules.

Following the Project Definition, Endeavour will draft a Protection and Indication Equipment Schedule (PIES) for Endeavour protection requirements in line with Endeavour policy, at this time the Customer must provide details of the Customer's proposed incoming circuit breaker protection scheme to enable Endeavour's Protection Engineers to review the design and draft a PCDA.

To enable the Customer or their electrical consultants to prepare protection and earthing reports, when requested, Endeavour will provide the phase to phase and phase to earth fault levels, network characteristics at the proposed feeders connection points under normal network operating conditions.

Revenue Metering and National Metering Identifier (NMI)

The Customer is responsible for the provision of separate metering on both incoming supplies. Metering transformers must be incorporated into the SLD to meeting the minimum requirements of Type 3 Metering for a high voltage installation however it is recommended that Type 2 Metering is designed and reviewed by the Customer's Electricity Retailer or Meter Provider for compliance with Chapter 7 "Metering" of the National Electricity Rules.

Prior to Commissioning the Customer's installation, Endeavour requires either the Meter Provider or the Electricity Retailer to provide written confirmation that compliant metering has been installed in accordance the National Electricity Rules and provide an NMI for each supply with the correct Standing Data and Network Tariff (N39 or Site Specific (GoR) - Refer Network Price List) for this type of connection. This written confirmation must be submitted to the Contestable Works Project Manager (undersigned) and received prior to commissioning of the Customer's High Voltage Installation.

It is further noted that metering transformer test certificates must be provided to Endeavour's Customer Installation Section as part of the documentation during the installation inspection, prior to connection of the Customer's installation.

Operational Arrangements

The Customer is responsible for operation and maintenance of the high voltage installation including 132kV electrical assets, metering and any agreed site-specific conditions beyond the Connection Point.

Prior to connection, the Customer must contact Endeavour's Network Security Manager, Mr John Pang (direct 02 9831 9054) to draft High Voltage Operation and Maintenance Protocol (Protocol) between Endeavour and the Customer. The site-specific conditions, including the division of responsibility, and operational and emergency contacts are to be included in the Protocol.

Site-specific conditions will be negotiated prior to connection and commissioning and once the Customer's installation is commissioned and connection assets accepted by Endeavour under the MSO, these site-specific conditions will form part Deemed Standard Connection Contract for Large Customers.

Power Factor

The installation Power Factor is to meet NSW Service and Installation Rules referring to National Electricity Rules requirements. These require a minimum 0.95 lagging Power Factor in accordance with section 5.3.5 'Power Factor Requirements' of National Electricity Rules.

It is expected that the installation will maintain unity (1.0) or less power factor and not enter a leading range.

If, following connection of this installation, the site power factor does not meet these requirements, it must be improved by connection of power factor correction units within the timeframe set at the time the improvement works are determined.

Quality of Supply Requirements

The voltage regulation and harmonic content resulting from the load being connected to the Endeavour Energy network must not affect the supply of adjacent customers. Therefore compliance is required with the criteria defined in the following documentation:-

AS/NZS 61000 Series;

- Part 3.2 relates to Harmonic Currents

- Parts 3.3 and 3.5 relate to Voltage Fluctuations and Flicker
- Parts 3.6 and 3.7 relates to Assessment of Emission Limits for “Distorting” and “Fluctuating” loads in MV and 132KV power systems.

Endeavour will set parameters outside of these documents in relation to the equipment being connected as part of the installation, therefore Endeavour will provide flicker and harmonic allocations consistent with the expected total load of the site.

Validity

This Connection Offer for a Standard Connection Service and is valid for twelve (12) months from the date of issue.

Where this letter has lapsed excluding Customer installation requirements, the appointed Level 3 ASP must contact Endeavour with the request to extend the Connection Offer. Endeavour will assess the request and will inform the ASP of the outcome. It must be recognised that the network is constantly extended/augmented as new customers are connected. This means that for the Connection Offer to be extended, the Connection Offer may require alteration. If this is the case, additional fees to cover administrative costs may apply.

Should you have any enquiries regarding your application please contact the undersigned.

Yours faithfully,

J. Lei

Jonathan Lei

Contestable Works Project Manager

Ph: 02 9853 7905

Email: Jonathan.Lei@endeavourenergy.com.au

21 December 2020

Endeavour Energy Ref: UCL10561– 2014/02306/001

Endeavour Energy
PO Box 811
Seven Hills NSW 1730
cwadmin@endeavourenergy.com.au

Attention: Contestable Works Administrator

NOTICE OF ADVICE

**APPOINTMENT OF ACCREDITED DESIGNER FOR THE PROPOSED DEVELOPMENT AT:
LOT 22, DP 258414, 757 MAMRE ROAD, KEMPS CREEK**

*** Please complete and return when a Level 3 Service Provider has been nominated***

Please accept this letter as notification that I intend to proceed with the development described above. I own or am developing the land and works on the land, (and/or where relevant on public land). I intend to supply this development to Endeavour Energy requirements.

By signing this Notice of Advice I am accepting the Terms and Conditions of Endeavour Energy's Model Standing Offer for a Standard Connection Service.

- Electricity Supply to Developments.

The Level 3 Service Provider appointed is:.....

The Fees will be Paid to Endeavour Energy by:

.....
Signature of Level 3 ASP

.....
Name of Level 3 ASP

.....
Signature of Applicant/ Applicant's Representative

.....
Name of Applicant/ Applicant's Representative

.....
Date

.....
Company Name

The signatory warrants that they are authorised to execute this Application.

Charlotte Ware

From: Jonathan Lei <Jonathan.Lei@endeavourenergy.com.au>
Sent: Thursday, 28 January 2021 10:21 AM
To: Michael Rosenberg; Charlotte Ware
Subject: [External] [REDACTED] data centre meeting/ Follow up
Attachments: South Erskine Park ZS SK1_Rev_A5_Proposed-A1.pdf

Hi Michael & Charlotte,

Following our last meeting for [REDACTED] data centre project held on the 13th Jan, I have obtained the following information regarding South Erskine Park ZS and your suggestion of provide extra conduits along the unformed Southern Link Rd for making proposed [REDACTED] data centre feeders as twin-cabled feeders.

- Attached is the proposed SEPKZS SLD at the time of the commissioning of the ZS (feeder CB connections are not shown).
As you can see from the SLD, N-1 security at 132kV Feeder and Transformer level are available at the time of the ZS commissioning. SEPKZS will initially have two single 22kV switchboards tied via a bus-section CB and twin 800mm² cables per phase. Future extension of 22kV switchboard is available.
- Total 10 feeder CBs will be available at time of commissioning (5 x feeder CBs per two sections of 22kV switchboard). As of today, planning has allocated 14 feeders for the known development in the area (including two single cable feeders for [REDACTED] data centre on different bus sections). There are already 5 feeder CBs will be double cabled connection including an Aux transformer. To have twin-cabled feeders to supply [REDACTED] data centre, one feeder CB will be standby only (the chance to utilise this feeder CB is very low).

The concern is there are still lots of vacant developable industrial land sitting around that we may soon run out of connection point at all.

- Endeavour project HVN04817 has been issued for TYPE 28 ducts along Southern Link Rd including a 100m underbore. Upgrading these to TYPE 2/10 ducts requires a wider trench and possibly two side by side underbores. There are concern about constructability of the underbore side by side. And a high level cost estimate to include the extra two ducts plus second underbore indicates it will probably add approx. \$215,000 to HVN04817.

If a second duct route is proposed, we would prefer this is on the opposite side of unformed Southern Link Rd. However, this may impact the project delivery due to risk dealing with future Southern Link road upgrade.

Under our current offer, [REDACTED] data centre will have one cable per feeder to provide 13.6MVA normal load (6.8MVA on each feeder) and reduced to 10MVA N-1 with one feeder out of service requiring up to 3.6MVA load shed to protect derated cables. The 10MVA N-1 in our connection offer is based on 0.65 derating factor considering that all other feeder cables in the same route are already in service. However, Based on the required connection date by [REDACTED] data centre, there is a good chance that only a few number of feeder cables may be in service at the connection date required by [REDACTED] data centre.

From our last meeting, I understand that the declared maximum demand of 13.6MVA is probably only required for commissioning phase which will run the full data centre equipment to test each single supply during the short period of commissioning program. From engineering perspective, this may still be allowed on single 240CU cable (full rating = 425A or 16MVA) if the actual derating is low and risk is acceptable by Endeavour for short period of time to allow customer to undertake commissioning exercise. However, to better assess the risk, I need a bit more details about estimated load and time period for commissioning requirements.

I understand that during normal operating, there shouldn't be issue for [REDACTED] data centre to split its loads over two single cable incoming feeders (e.g. 6.8MVA on each feeder); the realisation of the loads under normal operation may still allow full N-1 back up (which allows up to 73.5% realisation of the loads).

I also understand that it is preferred by customer not to have incoming bus section CB & coupler between two 22kV MSBs. This is acceptable if [REDACTED] data centre has LV bus sections/interconnections to allow back up for 10MVA N-1 under the HV contingencies.

On above understanding and considering aspect of asset utilisation, cost and project delivery, it is Endeavour's preference to have two single cable feeders to supply 13.6MVA normal & 10MVA N-1 with consideration allowing customer to commission the equipment with higher loads which are yet to be assessed. Can you please discuss this option with [REDACTED] data centre and advise the expected commissioning requirements? happy to arrange another meeting to discuss above details if required.

Regards

Jonathan Lei

Contestable Works Project Manager

Network Connections

D: (02) 9853 7905

F: (02) 9853 7925

M: 0448173719

E: jonathan.lei@endeavourenergy.com.au

490 Hoxton Park Road, Hoxton Park NSW 2171

www.endeavourenergy.com.au



- NOTES:
1. ALLOW SPACE FOR FUTURE 132kV BUS SECTION C&.
 2. ALLOW SPACE FOR FUTURE No.3 TRANSFORMER
 3. T3 IS ONLY REQUIRED IF NO CMEN SYSTEM IS REQUIRED
 4. BUS SECTION 2-3 SK2622 CT C2 TO BE SHORT CIRCUIT TO EXTEND THE BBP ZONE ACROSS THE BUS STUB ZONE.

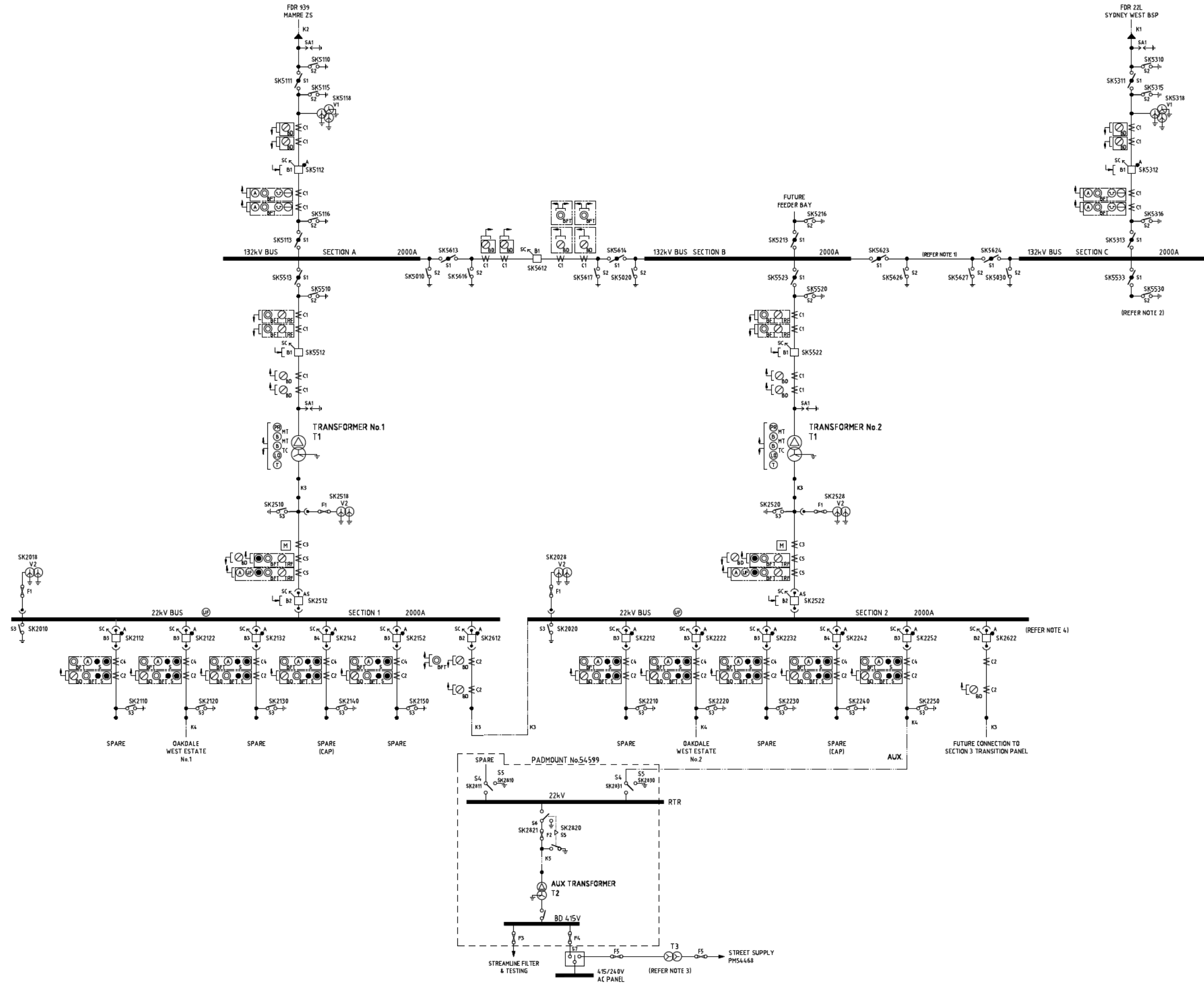

V2	VT 22kV/110V 50VA 0.5M/3P (3 x SINGLE PHASE)
V1	VT 132kV /110V/110V 100VA 0.2/1P (3 x SINGLE PHASE)
T3	ISOLATING TRANSFORMER 4.33/4.33 40kVA YNyn0
T2	AUXILIARY TRANSFORMER 22kV/4.15V 315kVA Dyn11
T1	MAIN TRANSFORMER 132/22kV 30/4.0/4.5 MVA ONAN/ODAN/ODAF Dyn 1
RTR	22kV SWITCHGEAR SIEMENS 8DJH 24kV 630A 16kA
SA1	SURGE ARRESTER 132kV
S7	SWITCH 4.15V CHANGE-OVER CONTACTOR
S6	SWITCH FUSE COMBINATION 24kV 200A 16kA
S5	SWITCH 24kV EARTHING 16kA
S4	SWITCH 24kV 630A 16kA
S3	SWITCH 22kV EARTHING 20kA
S2	SWITCH 132kV EARTHING 4.0kA
S1	SWITCH 132kV 2500A 4.0kA
K5	CABLE 22kV 35 sq mm Cu SINGLE CORE XLPE
K4	CABLE 22kV 24.0 sq mm Cu 3 CORE XLPE WITH 13.1kA SCREENS
K3	CABLE 22kV 800 sq mm Cu SINGLE CORE XLPE WITH 20kA SCREENS (2 CABLES PER PHASE) 59MVA
K2	CABLE 132kV SINGLE CORE STRANDED Cu 31.5kA SCREEN XLPE CORRUGATED A1 SHEATH CABLE (CABLE SIZE TO BE DETERMINED DURING DETAILS DESIGNS) - 170MVA
K1	CABLE 132kV SINGLE CORE STRANDED Cu 31.5kA SCREEN XLPE CORRUGATED A1 SHEATH CABLE (CABLE SIZE TO BE DETERMINED DURING DETAILS DESIGNS) - 270MVA
F5	FUSE 440V 100A
F4	FUSE 440V 160A
F3	FUSE 440V 250A
F2	FUSE 22kV 25A
F1	FUSE 22kV 3.15A
DB	AUXILIARY TRANSFORMER DISTRIBUTION PANEL (630A BUSBAR)
C5	CT 22kV 2000/1 0.15PX700R6
C4	CT 22kV 600/1 2.5VA 5P20
C3	CT 22kV 2000/1 5VA 0.5S FS10
C2	CT 22kV 2000/1 0.15PX350R6
C1	CT 132kV 2000/1500/1000/1 0.05PX150(Rct+2) @ 2000/1
B4	CB 22kV 630A 20kA (CAPACITOR UNIT)
B3	CB 22kV 630A 20kA
B2	CB 22kV 2000A 20kA
B1	CB 132kV 2500A 4.0kA
ITEM	DESCRIPTION

REV	NO	DATE	BY	CHKD	APPD	DESCRIPTION
A5						TRV AUX S/GEAR SWITCH REVISED.
						NEW NOTE ADDED TO SECTION 2.
						REVISION A4 PER DIGITAL ZS REQUIREMENTS.
						REVISION A3 22kV CTS REVISED AS PER DIGITAL ZS REQUIREMENTS.
						REVISION A2 HISTORY

PRELIMINARY

DESIGNED	A.R.	DATE	25.01.19
DRAWN	KT		
CHECKED	A.R.		



PROPOSED SOUTH ERSKINE PARK ZONE
SUBSTATION 9802
SINGLE LINE DIAGRAM

DO NOT SCALE DIMENSIONS IN MILLIMETRES		AUTHORISED/CERTIFIED	
SUBSTATION DESIGN MANAGER		A1 SKETCH1	
		SHEET No. 1 OF 1 SHEETS	

B2 EPA Consultation

Subject: FW: SSD-10101987: emergency standby generators

From: Shaun Williams <Shaun.Williams@planning.nsw.gov.au>

Sent: Thursday, 28 January 2021 3:53 PM

To: Rory Brenan <Rory.Brenan@arup.com>

Cc: Lucy Guerin <Lucy.Guerin@arup.com>; Rhys Inez <rhys.inez@epa.nsw.gov.au>; William Hodgkinson <William.Hodgkinson@planning.nsw.gov.au>

Subject: [External] RE: SSD-10101987: emergency standby generators

Hi Rory,

Apologies for the delay in response.

I have consulted with Rhys from EPA regarding your below inquiry.

The Department and EPA both interpret 'plant' referenced in Schedule 1, Clause 17 of the POEO Act to encompass all generators on the premises collectively, and that 'operate' would also include testing should the internal combustible engines be turned on during testing.

This advice has been consistent across recent data centre SSD applications. For example please see the below links to advice provided by EPA for the Robert's Road Data Centre (SSD-10330) and the Augusta Street Data Centre (SSD-10469).

Roberts Road Data Centre -

<https://majorprojects.planningportal.nsw.gov.au/prweb/PRRestService/mp/01/getContent?AttachRef=PAE-3421%2120200618T222046.112%20GMT>

Augusta Street Data Centre -

<https://majorprojects.planningportal.nsw.gov.au/prweb/PRRestService/mp/01/getContent?AttachRef=PAE-9425583%2120201019T234357.096%20GMT>

At this stage the Department does not consider any further formal discussion regarding this matter to be necessary.

Regards,

Shaun Williams

A/Senior Environmental Assessment Officer

Industry Assessments | Department of Planning, Industry and Environment

T 02 8275 1345 | E shaun.williams@planning.nsw.gov.au

4PSQ Level 17, 12 Darcy Street, Parramatta NSW 2150 | Locked Bag 5022, Parramatta NSW 2124

www.dpie.nsw.gov.au



Planning,
Industry &
Environment

The Department of Planning, Industry and Environment acknowledges that it stands on Aboriginal land. We acknowledge the traditional custodians of the land and we show our respect for elders past, present and emerging through thoughtful and collaborative approaches to our work, seeking to demonstrate our ongoing commitment to providing places in which Aboriginal people are included socially, culturally and economically.

From: Rory Brennan <Rory.Brenan@arup.com>
Sent: Monday, 11 January 2021 11:22 AM
To: Shaun Williams <Shaun.Williams@planning.nsw.gov.au>; Rhys Inez <rhys.inez@epa.nsw.gov.au>
Cc: Lucy Guerin <Lucy.Guerin@arup.com>; Ben Hooper <Ben.Hooper@arup.com>; Michael Rosenberg <Michael.Rosenberg@arup.com>; Charlotte Ware <Charlotte.Ware@arup.com>; [REDACTED]
[REDACTED]; [REDACTED]
[REDACTED]; Chris Fay <Chris-B.Fay@arup.com>; [REDACTED]
[REDACTED]
Subject: SSD-10101987: emergency standby generators

Hi Shaun, Rhys

We are reaching out in relation to the attached SEARs advice for the proposed Kemps Creek Data Centre (SSD-10101987). Please note, we understand that the NSW State Government has signed a non-disclosure agreement with [REDACTED] in relation to this project – please ensure compliance with this NDA at all times and let us know if you have any questions or concerns.

We would like to arrange a teleconference to discuss and clarify DPIE's and the EPA's interpretation of POEO Act Schedule 1, Clause 17. In particular, we are seeking clarification on the statement in the attached response that:

“the definition of ‘plant’ in this scheduled activity includes all generators on the premises, not each individual generator”

We are concerned that this statement is open to misinterpretation, and could result in consent conditions which are not reflective of the intent of the Act, nor the precedent of how it has always previously been applied to emergency backup generation plant.

As such we are hoping to provide some clarifications regarding the proposed design and operation of the diesel generators, and to seek a clearer understanding of how the SSD consent conditions may respond to this proposal.

Could you please advise your availability for this/next week?

Kind regards

Rory Brennan
Senior Electrical Engineer CEng
Sydney Buildings

Arup
Gadigal Country, Barrack Place, 151 Clarence Street, Sydney NSW 2000
d: +61 2 9320 9786
m: +61 400 574 035
www.arup.com

Arup is owned in trust on behalf of its staff. The result is an independence of spirit that is reflected in the firm's work, and in its dedicated pursuit of technical excellence.

Electronic mail messages entering and leaving Arup business systems are scanned for viruses and acceptability of content.

Appendix C

Sydney Water Consultations

3 December 2020

ARUP PTY LTD
c/- RMA INFRASTRUCTURE PTY LTD

FEASIBILITY LETTER

Developer: ARUP PTY LTD
Your reference: W-11738
Development: Lot 1 DP1018318 MAMRE RD, Kemps Creek
Development Description: Proposed Data Centre
Your application date: 8 October 2020

Note: Level 1 water restrictions are now in place, which limits how and when water can be used outdoors. This can impact you and your contractors in the activities they need to undertake for this proposal.

Using water to suppress dust is not restricted, but this does mean that you/your contractors will need to apply for an exemption permit to use water for most outdoor uses including:

- Cleaning equipment and the exterior of new buildings
- Drilling and boring, and
- Batching concrete on-site

Fines for deliberate breaches of restriction rules apply from 1 September 2019.

For more information on the restrictions and for applying for an exemption, visit our web site at <http://www.sydneywater.com.au/SW/water-the-environment/what-we-re-doing/water-restrictions/index.htm>

The more water everyone saves, the longer we can stave off the progression to stricter restrictions or emergency measures.

Please provide this information to your contractors and delivery partners to inform them of their obligations.

Dear Applicant

This Feasibility Letter (Letter) is a guide only. It provides general information about what Sydney Water's requirements could be if you applied to us for a Section 73 Certificate (Certificate) for your proposed development. **The information is accurate at today's date only.**

If you obtain development consent for the development from your consent authority (this is

usually your local Council) they will require you to apply to us for a Section 73 Certificate. You will need to submit a new application (and pay another application fee) to us for that Certificate by using your current or another Water Servicing Coordinator (Coordinator).

Sydney Water will then send you either a:

- Notice of Requirements (Notice) and Developer Works Deed (Deed); or
- Certificate.

These documents will be the definitive statement of Sydney Water's requirements. Sydney Water has yet to finalise the Recycled Water Servicing Strategy for Mamre Road Precinct. As this will occur in the future, Sydney Water advises that your application may be subject to an additional requirement to include a third pipe network which should be included as part of the design requirements as listed in Section 4.2. If the Recycled Water Servicing Strategy is not determined by the time construction is to commence, Sydney Water will advise whether Section 4.2.1 will still be required for final notice to be issued.

There may be changes in Sydney Water's requirements between the issue dates of this Letter and the Notice or Certificate. The changes may be:

1. Developer Charges

- (a) Adjustment of charges due to the Consumer Price Index (CPI);
- (b) Adjustment of charges because of a scheduled review by the Independent Pricing and Review Tribunal (IPART). After that review and registration of the new charges, Sydney Water has to apply those charges; or
- (c) If there is rezoning of any land within the development proposal then new charges will apply.

2. Changing the Proposed Development

- If you change your proposed development, e.g. the development description or the plan/site layout, after today, the requirements in this Letter could change when you submit your new application; and
- if you decide to do your development in stages then you must submit a new application (and pay another application fee) for each stage.

What You Must Do To Get A Section 73 Certificate in the Future

To get a Section 73 Certificate in the future you must do the following things. You can also find out about this process by visiting www.sydneywater.com.au > Plumbing, building & developing > Developing > Land Development.

1. **Obtain Development Consent from the consent authority for your development proposal.**
2. **Engage a Water Servicing Coordinator (Coordinator).**

You must engage your current or another authorised Coordinator to manage the design and construction of works that you must provide, at your cost, to service your development. If you wish to engage another Coordinator (at any point in this process) you must write and tell Sydney Water.

For a list of authorised Coordinators, either visit www.sydneywater.com.au > Plumbing, building & developing > Developing > Providers > Lists or call **13 20 92**.

The Coordinator will be your point of contact with Sydney Water. They can answer most questions that you might have about the process and developer charges and can give you a quote or information about costs for services/works (including Sydney Water costs).

3. **Developer Works Deed**

After the Coordinator has submitted your new application, they will receive the Sydney Water Notice and Developer Works Deed. You and your accredited Developer Infrastructure Providers (Providers) will need to sign and lodge both copies of the Deed with your nominated Coordinator. After Sydney Water has signed the documents, one copy will be returned to the Coordinator.

The Deed sets out for this project:

- your responsibilities;
- Sydney Water's responsibilities; and
- the Provider's responsibilities.

You must do all the things that we ask you to do in that Deed. This is because your development does not have sewer services and you must construct and pay for the following works extensions under this Deed to provide these services.

Note: The Coordinator must be fully authorised by us for the whole time of the agreement.

4. **Drinking Water, Recycled Water and Sewer Works**

4.1 Drinking Water

Sydney Water has noted the water demands you have provided (**Figure 1**).

Year - Qtr	IST (MW)	Maximum IT Capacity (MW)	Peak Day Water Consumption (kL/day)	Maximum Drainage Requirement (kL/day)
2022 Q2	12.96	0		
2023 Q3**	0	9.6	276.5	276.5
2024 Q3	0	19.2	553.0	553.0
2025 Q3	0	28.8	829.4	829.4
2026 Q3	0	48.0	1382.4	1382.4
2027 Q3	0	57.6	1658.9	1658.9
2028 Q3	0	76.8	2211.8	2211.8
2029 Q3	0	96.0	2764.8	2764.8
2030 Q3	0	100.8	2903.0	2903.0
2031 Q3	0	105.6	3041.3	3041.3
2032 Q3	0	110.4	3179.5	3179.5
2033 Q3	0	115.2	3317.8	3317.8
2034 Q3	0	124.8	3594.2	3594.2
2035 Q3	0	134.4	3870.7	3870.7
2036 Q3	0	144.0	4147.2	4147.2

Table 23: Site Wastewater Demands

Noted: 533k/day peak water consumption required April 2022

Full capacity: peak instantaneous demand: 90 L/s and 52.4 L/s average over the peak day

Figure 1: [REDACTED] datacentre potable water demands

The proposed development is currently located within Cecil Park Reduced Water Supply Zone (WSZ) which does not have capacity to service developments within the Mamre Road precinct prior to delivery of major system amplifications by 2023/24.

Sydney Water has assessed your application and found that there are two interim options for servicing Drinking Water before 2023/24, by supplying your development from Erskine Park Elevated WSZ (**Figure 2**).

Both interim options are dependent on a proposed DN300 drinking water main from James Erskine Drive to the Mamre Road/Bakers Lane intersection, delivered by another developer and expected to be constructed by October 2021.

4.1.1 Interim Option 1 'Extend'

- The DN300 drinking water main from James Erskine Drive to the Mamre Road/Bakers Lane intersection will need to be extended with a new private DN300 in Crown Reserve Road (referred to for convenience here as Bakers Lane West), with a new DN300 offtake.
 - Note: offtake main size will be confirmed at detailed design phase; PSV or flow control device may be required
 - Note: your proposed development is within an estate, where servicing strategy has already been determined; you will need to coordinate with that developer for works to service your development. Sydney Water is unlikely to approve duplicate water networks within the estate.
 - Note: this interim servicing option is dependent on delivery of the DN300 from James Erskine Drive by others.

4.1.2 Interim Option 2 'Upgrade'

- The existing DN200 drinking water main in Bakers Lane West will need to be upgraded to a DN300, with a new DN300 offtake

- Note: offtake main size will be confirmed at detailed design phase; PSV or flow control device may be required
- Note: your proposed development is within an estate, where servicing strategy has already been determined; you will need to coordinate with that developer for works to service your development. Sydney Water is unlikely to approve duplicate water networks within the estate.
- Note: this interim servicing option is dependent on delivery of the DN300 from James Erskine Drive by others.

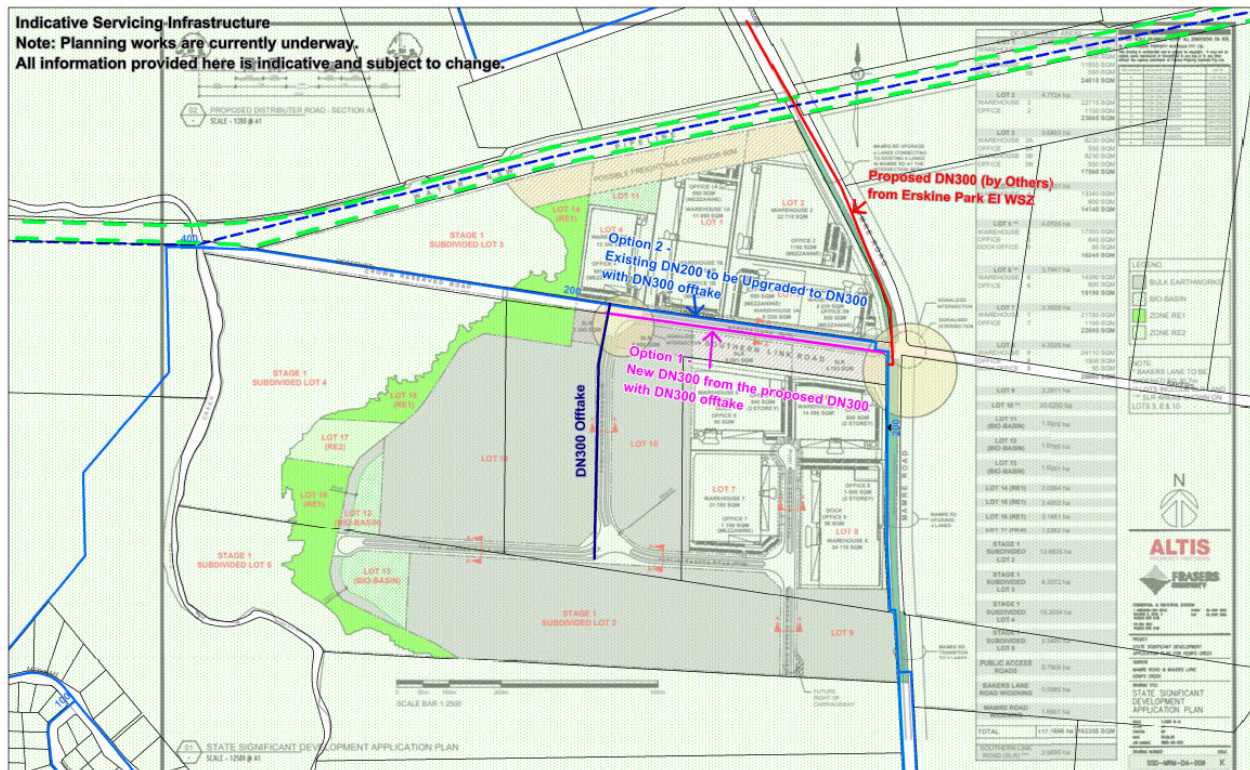

Figure 2: Interim drinking water options

- Your development must have its own connection to a water main and a water service and meter.
- Precinct trunk drinking water mains and reticulation mains are required to be sized as per the WSAA code.
- Your development must have a frontage to a water main that is the right size and can be used for connection.
- Supply transfer zone change may be required in 2022 - additional connection to Cecil Park water supply zone from Mamre Rd water main

4.2 Recycled Water

4.2.1 Tertiary ('purple pipe')

The following advice is subject to change depending on Sydney Water's Recycled Water Servicing Strategy confirmation. Sydney Water will confirm the methodology by which connections are to be made at a later stage.

- Each lot in your subdivision must have a frontage to a recycled water main that is the right size and can be used for connection. They must comply with the standards for Dual Water Reticulation Systems.

4.2.2 Sydney Water's Standards for Dual Water Reticulation

Your subdivision is in an area where drinking water is available and where recycled water may be available. The drinking and recycled water works required above must comply with the standards for Dual Water Reticulation Systems that are set down in the *Water Supply Code of Australia Sydney Water Edition - 2014* (the Code).

These standards require that service connections and property services be provided for both drinking and recycled water for each lot in the subdivision. The installation of these services must either be carried out or supervised by a licensed plumber.

It must satisfy the:

- (a) Administrative requirements of the New South Wales Code of Practice for Plumbing and Drainage; and
- (b) Technical requirements of the Dual Water Drawings Set within the Code.

4.2.3 Advanced Recycled Water

- Sydney Water is currently planning to deliver the Upper South Creek Advanced Water Recycled Centre by 2026.
- Once commissioned, this plant will deliver high quality advanced recycled water that meets almost all of the data centre's water quality requirements
 - Note: Sydney Water is only required to design and model quality parameters specific for our environment licences and generic recycled water quality requirements. Hence, our current modelling hasn't taken into consideration all of the parameters that are required for your datacentre needs.
 - If there is interest from your client, Sydney Water can, at a small additional fee, do additional modelling to confirm water quality standards compared to your datacentre needs.
- Sydney Water is exploring opportunities to build a dedicated Advanced Recycled Water pipeline to service large specialised water users in Mamre Precinct and welcomes the opportunity to further discuss this with [REDACTED] and Arup.

4.3 Sewer

Sydney Water has noted the wastewater demands you have provided (**Figure 4**).

Year - Qtr	IST (MW)	Maximum IT Capacity (MW)	Peak Day Water Consumption (kL/day)	Maximum Drainage Requirement (kL/day)
2022 Q2	12.96	0		
2023 Q3**	0	9.6	276.5	46.5
2024 Q3	0	19.2	553.0	92.9
2025 Q3	0	28.8	829.4	139.4
2026 Q3	0	48.0	1382.4	232.3
2027 Q3	0	57.6	1658.9	278.7
2028 Q3	0	76.8	2211.8	371.6
2029 Q3	0	96.0	2764.8	464.5
2030 Q3	0	100.8	2903.0	487.8
2031 Q3	0	105.6	3041.3	511.0
2032 Q3	0	110.4	3179.5	534.2
2033 Q3	0	115.2	3317.8	557.4
2034 Q3	0	124.8	3594.2	603.9
2035 Q3	0	134.4	3870.7	650.3
2036 Q3	0	144.0	4147.2	696.8

Table 23: Site Wastewater Demands

Noted: 46.5KL/day max drainage required April 2022

Figure 4: [REDACTED] datacentre wastewater demand

Sydney Water has assessed your application and advises that:

- The Mamre Road Precinct does not currently have wastewater servicing available.
- Your development is located within the western catchment of the Precinct, and will drain to a proposed wastewater pumping station (anticipated to be delivered by 2023/24) which would transfer flows to St Marys until 2026, after which flows would transfer to the new Upper South Creek AWRC. **(Figure 5)**
- Your proposed development is within an estate, where servicing strategy has already been determined, including an Interim Operating Plan (IOP) for interim wastewater servicing until the delivery of the wastewater pumping station noted above.
 - Note: this developer's IOP has been endorsed by Sydney Water and only considers warehouse demands for their entire estate, including the lot on which your proposed development is located. The wastewater demands of the datacentre have not been considered.
 - Sydney Water is unable to endorse an additional IOP within this estate to service just the datacentre, as per our IOP Guidelines. Additionally, we are unlikely to approve duplicate wastewater networks within the estate.
 - In order to ensure wastewater servicing for your development, you will need to coordinate with the other developer to ensure their IOP and corresponding wastewater network is sized appropriately to accommodate your demands.
 - § Note: any expansion to an already endorsed IOP size is subject to further Sydney Water approval.
- Your development must have a sewer main that is the right size and can be used for connection. That sewer must also have a connection point within your development's boundaries.

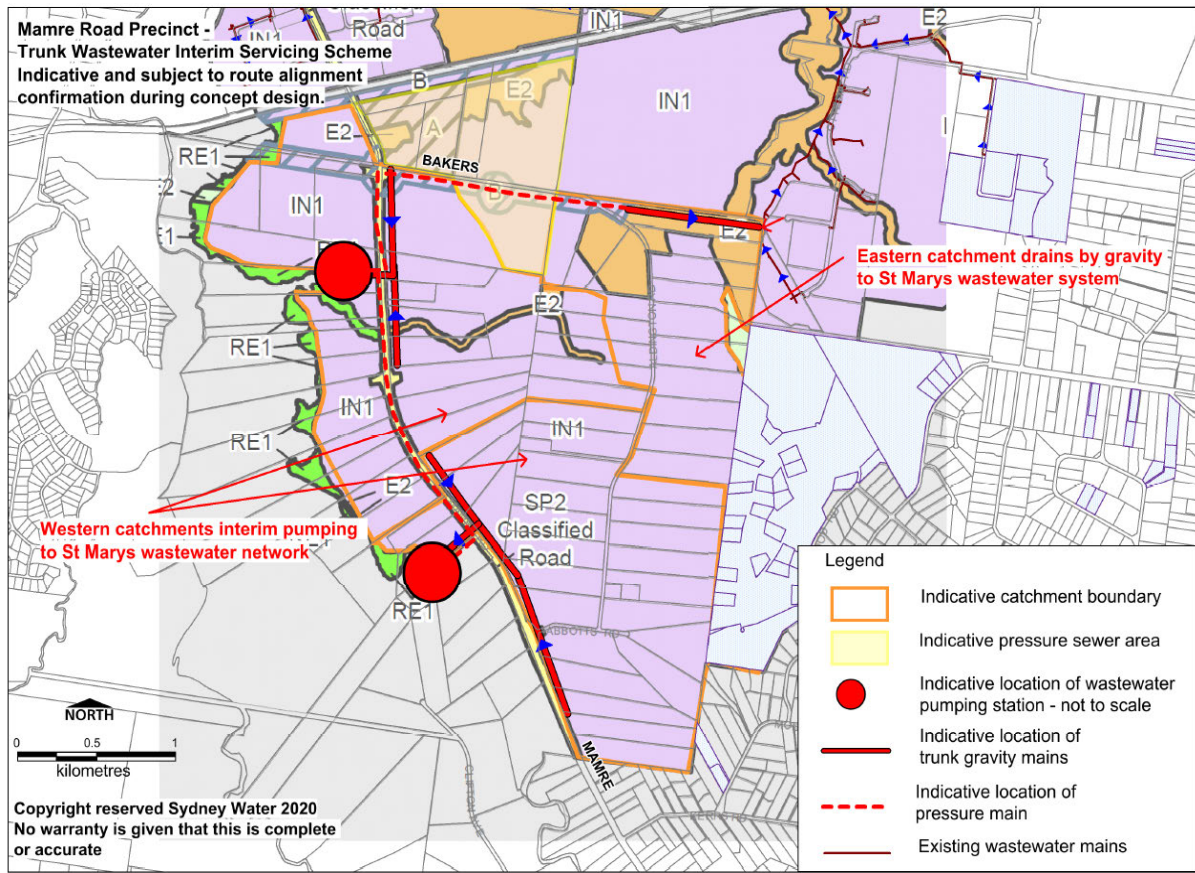

Figure 5: Sydney Water Mamre Road wastewater servicing strategy

5. Ancillary Matters

5.1 Asset adjustments

If any Sydney Water drinking water main, recycled water main, sewer or stormwater asset constructed or under construction is found, after the issue of this Notice, to require adjustment or deviation as a result of your development; then this work must be undertaken in conjunction with the abovementioned sewer extension. If this happens, you will need to do this work as well as the extension we have detailed above at your cost. The work must meet the conditions of this Notice and you will need to complete it **before we can issue the Certificate**. Sydney Water will need to see the completed designs for the work and we will require you to lodge a security. The security will be refunded once the work is completed.

5.2 Entry onto neighbouring property

If you need to enter a neighbouring property, you must have the written permission of the relevant property owners and tenants. You must use Sydney Water's **Permission to Enter** form(s) for this. You can get copies of these forms from your Coordinator or the Sydney Water website. Your Coordinator can also negotiate on your behalf. Please make sure that you address all the items on the form(s) including payment of compensation and whether there are other ways of designing and constructing that could avoid or reduce their impacts.

You will be responsible for all costs of mediation involved in resolving any disputes. Please allow enough time for entry issues to be resolved.

5.3 Costs

Construction of these **future** works will require you to pay project management, survey, design and construction costs **directly to your suppliers**. Additional costs payable to Sydney Water may include:

- water main shutdown and disinfection;
- connection of new water mains to Sydney Water system(s);
- design and construction audit fees;
- contract administration, Operations Area Charge & Customer Redress prior to project finalisation;
- creation or alteration of easements etc; and
- water usage charges where water has been supplied for building activity purposes prior to disinfection of a newly constructed water main.

Note: Payment for any Goods and Services (including Customer Redress) provided by Sydney Water will be required prior to the issue of the Section 73 Certificate or release of the Bank Guarantee or Cash Bond.

Your Coordinator can tell you about these costs.

OTHER THINGS YOU NEED TO DO:

Shown below are other things you need to do that are NOT a requirement for the Certificate. They may well be a requirement of Sydney Water in the future because of the impact of your development on our assets. You must read them before you go any further.

Approval of your building plans

Please note that your building plans must be approved. This can be done at Sydney Water Tap in™. Visit www.sydneywater.com.au > Plumbing, building & developing > Building > Sydney Water Tap in™ or call 13 20 92.

This is not a requirement of the Certificate but the approval is needed because construction/ building works may impact on existing Sydney Water assets (e.g. water and sewer mains). In any case, these works MUST NOT commence until Sydney Water has granted approval.

Your Coordinator can tell you about the approval process including:

- Possible requirements;
- Costs; and
- Timeframes.

Note: You must obtain our written approval before you do any work on Sydney Water's

systems. Sydney Water will take action to have work stopped on the site if you do not have that approval. We will apply Section 44 of the *Sydney Water Act 1994*.

Disused Sewerage Service Sealing

Please do not forget that you must pay to disconnect all disused private sewerage services and seal them at the point of connection to a Sydney Water sewer main. This work must meet Sydney Water's standards in the Plumbing Code of Australia (the Code) and be done by a licensed drainer. The licensed drainer must arrange for an inspection of the work by a NSW Fair Trading Plumbing Inspection Assurance Services (PIAS) officer. After that officer has looked at the work, the drainer can issue the Certificate of Compliance. The Code requires this.

Soffit Requirements

Please be aware that floor levels must be able to meet Sydney Water's soffit requirements for property connection and drainage.

Requirements for Business Customers for Commercial and Industrial Property Developments

If this property is to be developed for Industrial or Commercial operations, it may need to meet the following requirements:

Trade Wastewater Requirements

If this development is going to generate trade wastewater, the property owner must submit an application requesting permission to discharge trade wastewater to Sydney Water's sewerage system. You must wait for approval of this permit before any business activities can commence.

The permit application should be emailed to Sydney Water's Business Customer Services at businesscustomers@sydneywater.com.au

It is illegal to discharge Trade Wastewater into the Sydney Water sewerage system without permission.

A **Boundary Trap** is required for all developments that discharge trade wastewater where arrestors and special units are installed for trade wastewater pre-treatment.

If the property development is for Industrial operations, the wastewater may discharge into a sewerage area that is subject to wastewater reuse. Find out from Business Customer Services if this is applicable to your development.

Backflow Prevention Requirements

Backflow is when there is unintentional flow of water in the wrong direction from a potentially polluted source into the drinking water supply.

All properties connected to Sydney Water's supply must install a testable **Backflow Prevention Containment Device** appropriate to the property's hazard rating. Property with a high or medium hazard rating must have the backflow prevention containment device tested annually. Properties identified as having a low hazard rating must install a non-testable device, as a

minimum.

Separate hydrant and sprinkler fire services on non-residential properties, require the installation of a testable double check detector assembly. The device is to be located at the boundary of the property.

Before you install a backflow prevention device:

1. Get your hydraulic consultant or plumber to check the available water pressure versus the property's required pressure and flow requirements.
2. Conduct a site assessment to confirm the hazard rating of the property and its services. Contact PIAS at NSW Fair Trading on **1300 889 099**.

For installation you will need to engage a licensed plumber with backflow accreditation who can be found on the Sydney Water website:

<http://www.sydneywater.com.au/Plumbing/BackflowPrevention/>

Water Efficiency Recommendations

Water is our most precious resource and every customer can play a role in its conservation. By working together with Sydney Water, business customers are able to reduce their water consumption. This will help your business save money, improve productivity and protect the environment.

Some water efficiency measures that can be easily implemented in your business are:

- Install water efficiency fixtures to help increase your water efficiency, refer to WELS (Water Efficiency Labelling and Standards (WELS) Scheme, <http://www.waterrating.gov.au/>
- Consider installing rainwater tanks to capture rainwater runoff, and reusing it, where cost effective. Refer to <http://www.sydneywater.com.au/Water4Life/InYourBusiness/RWTCalculator.cfm>
- Install water-monitoring devices on your meter to identify water usage patterns and leaks.
- Develop a water efficiency plan for your business.

It is cheaper to install water efficiency appliances while you are developing than retrofitting them later.

Contingency Plan Recommendations

Under Sydney Water's [customer contract](#) Sydney Water aims to provide Business Customers with a continuous supply of clean water at a minimum pressure of 15meters head at the main tap. This is equivalent to 146.8kpa or 21.29psi to meet reasonable business usage needs.

Sometimes Sydney Water may need to interrupt, postpone or limit the supply of water services to your property for maintenance or other reasons. These interruptions can be planned or unplanned.

Water supply is critical to some businesses and Sydney Water will treat vulnerable customers, such as hospitals, as a high priority.

Have you thought about a **contingency plan** for your business? Your Business Customer Representative will help you to develop a plan that is tailored to your business and minimises productivity losses in the event of a water service disruption.

For further information please visit the Sydney Water website at: <http://www.sydneywater.com.au/OurSystemsandOperations/TradeWaste/> or contact Business Customer Services on **1300 985 227** or businesscustomers@sydneywater.com.au

Fire Fighting

Your firefighting service must be drawn from the recycled water system.

Definition of fire fighting systems is the responsibility of the developer and is not part of the Section 73 process. It is recommended that a consultant should advise the developer regarding the fire fighting flow of the development and the ability of Sydney Water's system to provide that flow in an emergency. Sydney Water's Operating Licence directs that Sydney Water's mains are only required to provide domestic supply at a minimum pressure of 15 m head.

A report supplying modelled pressures called the Statement of Available pressure can be purchased on-line through Sydney Water Tap in™ and may be of some assistance when defining the fire fighting system. The Statement of Available pressure, may advise flow limits that relate to system capacity or diameter of the main and pressure limits according to pressure management initiatives. If mains are required for fire fighting purposes, the mains shall be arranged through the water main extension process and not the Section 73 process.

Large Water Service Connections (Dual Water)

A drinking water main and (subject to the information above) a recycled water main may be available, once you have completed your drinking and recycled water main construction to serve your subdivision. The size of your subdivision means that you will need dual water connections larger than the standard domestic 20 mm size.

To get approval for your connection, you will need to lodge an application with Sydney Water Tap in™. You, or your hydraulic consultant, may need to supply the following:

- A plan of the hydraulic layout;
- A list of all the fixtures/fittings within the property;
- A copy of the fireflow pressure inquiry issued by Sydney Water;
- A pump application form (if a pump is required);
- All pump details (if a pump is required).

You will have to pay an application fee.

The service connection will need to meet with:

Administrative requirements of the Plumbing Code of Australia; and
Technical requirements of the Dual Water Drawings Set within the Code.

Sydney Water does not consider whether a water main is adequate for fire fighting purposes for your development. We cannot guarantee that this water supply will meet your Council's fire fighting requirements. The Council and your hydraulic consultant can help.

Disused Water Service Sealing

You must pay to disconnect all disused private water services and seal them at the point of connection to a Sydney Water water main. This work must meet Sydney Water's standards in the Plumbing Code of Australia (the Code) and be done by a licensed plumber. The licensed plumber must arrange for an inspection of the work by a NSW Fair Trading Plumbing Inspection Assurance Services (PIAS) officer. After that officer has looked at the work, the drainer can issue the Certificate of Compliance. The Code requires this.

Other fees and requirements

The requirements in this Advice Letter relate to your future Certificate application only. Sydney Water may be involved with other aspects of your development and there may be other fees or requirements. These include:

- construction/building plan approval fees;
- plumbing and drainage inspection costs;
- the installation of backflow prevention devices;
- trade waste requirements;
- large water connections and
- council fire fighting requirements. (It will help you to know what the fire fighting requirements are for your development as soon as possible. Your hydraulic consultant can help you here.)

No warranties or assurances can be given about the suitability of this document or any of its provisions for any specific transaction. It does not constitute an approval from Sydney Water and to the extent that it is able, Sydney Water limits its liability to the reissue of this Letter or the return of your application fee. You should rely on your own independent professional advice.

END

21 June 2021

(Via email)

**Water and wastewater servicing for development
SSD-10101987 (Kemps Creek Data Centre) at 709-769 Mamre Road, Kemps Creek**

Dear

Thank you for your continued engagement with Sydney Water on our servicing strategy for the Mamre Road precinct. Sydney Water is committed to ensuring services get delivered at the right time to keep Western Sydney thriving and productive, and we are excited to be able to support you in achieving the best outcomes for your development.

Water

Sydney Water has noted the data centre's maximum daily water consumption requirements and, as per the draft Mamre Road DCP, we anticipate that recycled water will be your primary supply for non-potable uses within your operations.

Your proposed facility will need to be connected to recycled water reticulation expected to be delivered by the estate developer under SSD 9522. Sydney Water will deliver the recycled water trunk network in the precinct, and recycled water is anticipated to be available from 2026 via the Upper South Creek Advanced Water Recycling Centre (AWRC). Developer contributions will be applicable for recycled water.

Sydney Water will continue to work with to finalise the recycled water servicing strategy specific to your site including meeting water quality and contingency requirements.

Interim servicing

We understand you anticipate that you will require peak day water consumption of 553KL/D from Q3 2022. The initial stages of your proposed development will be supplied by potable water, once the amplification works noted below are complete, and this servicing will continue until recycled water is available from the AWRC.

Your proposed development is currently located within Cecil Park Reduced Water Supply Zone (WSZ) and is part of the Prospect South Water Delivery System. In anticipation of growth, Sydney Water has fast-tracked planning and delivery of water infrastructure, with

the following water infrastructure amplification projects proposed to be operational in the first quarter of 2022:

- Rising Main (DN900) and pump WP0433 and 60ML reservoir at Liverpool
- DN1200/DN1050 from Cecil Park Reservoir up to Western Rd, with offtakes at Range Rd and Western Rd connecting existing mains in Elizabeth Drive

The following additional amplification works are also required:

- A new DN300 lead in water main down Mamre Road to Bakers Lane that will bring water in from the Erskine Park Elevated Water Supply Zone as an interim supply. This main is being delivered by another developer and is currently expected to be operational by late 2021.
- Developers will be required to upsize drinking water mains fronting their developments to DN300 to ensure connection and supply. As your development is within the estate developed under SSD 9522, Sydney Water has been supportive of coordinated delivery of infrastructure to service both developments. We advise that a DN300 extension west from Baker's Lane intersection to the estate frontage and a DN300 offtake is required as an interim water servicing solution for the data centre. It is expected that once recycled water is available, the drinking water main will no longer be used as the primary source for non-potable uses.
- Please note that offtake main size will be confirmed at detailed design phase, with potential need for additional pressure or flow control devices to ensure that the water system meets the requirements set out in our Operating Licence.
- Additionally, we advise to plan for onsite storage to mitigate the risk of supply loss and to cater for the data centre's peak demands.

Wastewater

As you are aware, there are no wastewater services currently available in the precinct. Sydney Water's stage 1 servicing solution is expected to be available around 2024 when your site will be drained to a new wastewater pumping station (SP1221) and transferred to the St Marys Wastewater Treatment Plant. Sydney Water is currently in concept planning phase for this pump station and associated trunk wastewater mains. Ultimately, your site will be serviced by the new AWRC, expected to be delivered in 2025/26, pending funding and other approvals.

Sydney Water will continue to work with and the estate developers to evaluate a temporary wastewater servicing solution designed and operated by the estate developer to service both developments until our stage 1 wastewater servicing is commissioned. We note that this interim solution is still in negotiation phase and has not yet been confirmed to date. We look forward to progressing these discussions with and the estate developers in Q3 2021, with the intent of having this interim solution in place in early 2022.

Sydney Water has had a successful partnership with _____ to date, and we look forward to working with you, other developers and agencies to further develop agile, innovative, sustainable and commercially sound solutions to service growth in the Mamre Road Precinct, other parts of the Aerotropolis and Western Sydney while contributing to a sustainable and liveable Western City.

As always, please feel free to reach out to myself or your Account Manager, Shalini Gonsalves on 0434 756 999 to continue these discussions.

We look forward to working with you.

Regards
Christian McNally



Manager, Developer Partnerships
Sydney Water

Appendix D

On-Site Utility Infrastructure

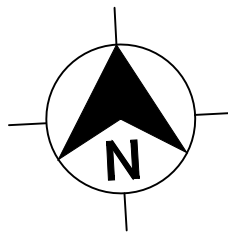

LEGEND:

- HV SWITCHING STATION
- BACKUP ELECTRICAL GENERATORS
- POTABLE AND INDUSTRIAL WATER TANKS AND PUMPS
- FIRE TANKS AND PUMPS
- STAGE 1 UTILITY INFRASTRUCTURE CONSTRUCTION

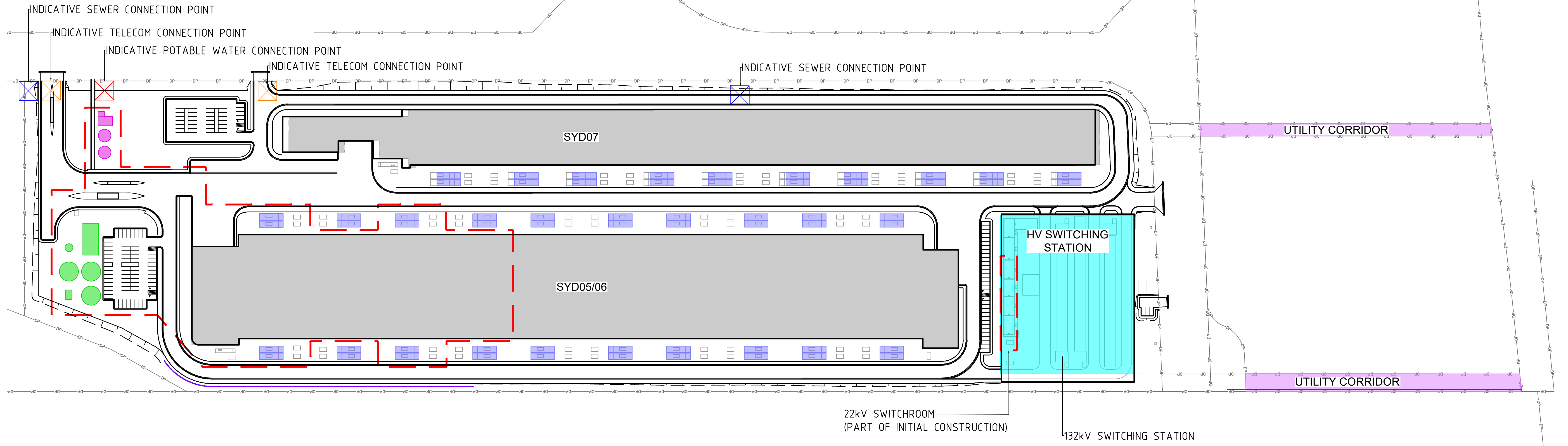

NOT FOR CONSTRUCTION