

**AUSTRALIAN STANDARD 85<sup>TH</sup> PERCENTILE SIZE VEHICLE (B85)**

Blue – Tyre Path  
Green – Vehicle Body  
Red – 300mm Clearance

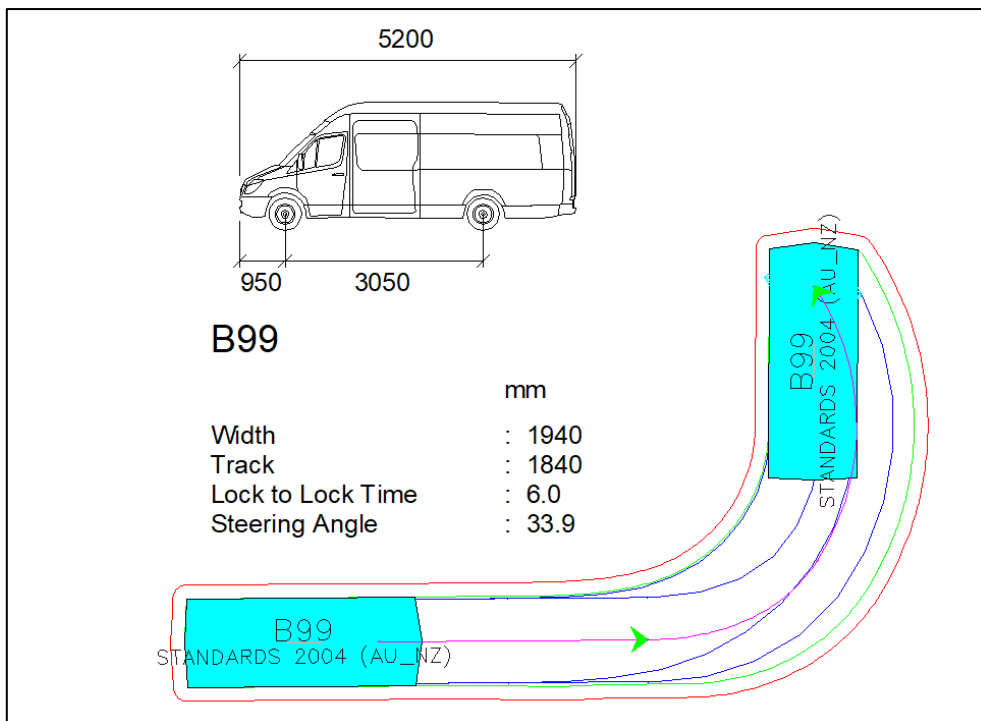

**AUSTRALIAN STANDARD 99.8<sup>TH</sup> PERCENTILE SIZE VEHICLE (B99)**

Blue – Tyre Path  
Green – Vehicle Body  
Red – 300mm Clearance

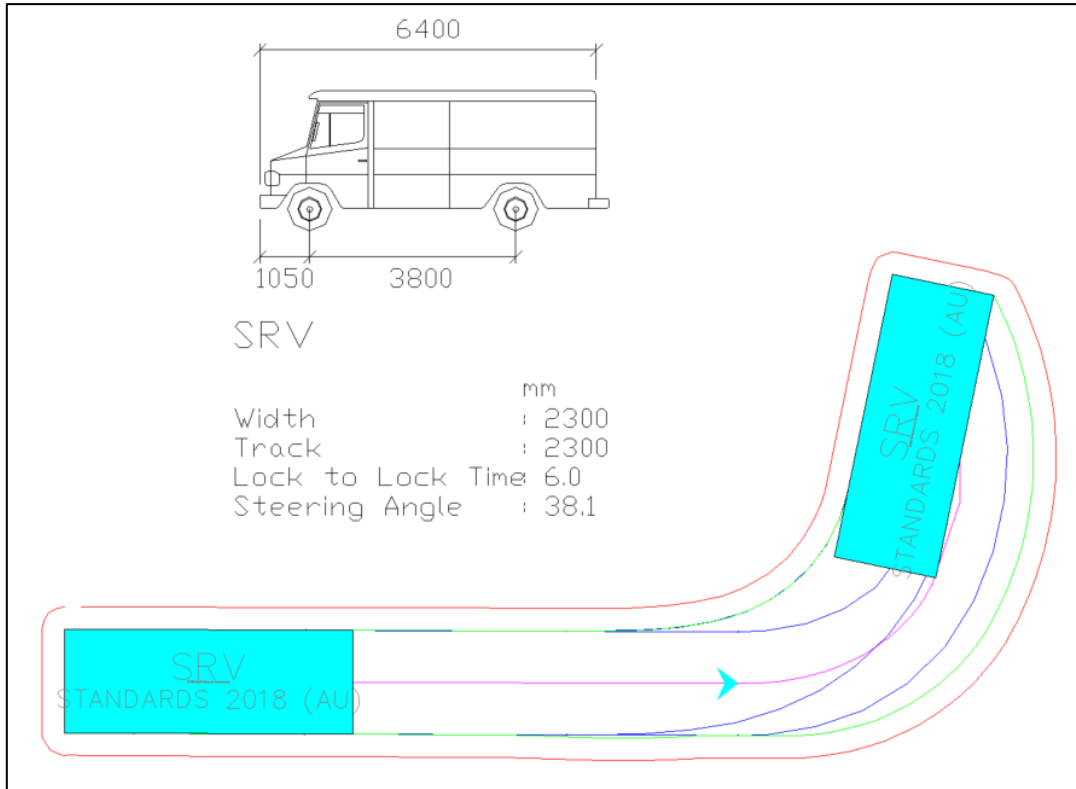

**AUSTRALIAN STANDARD SMALL RIGID VEHICLE (SRV)**

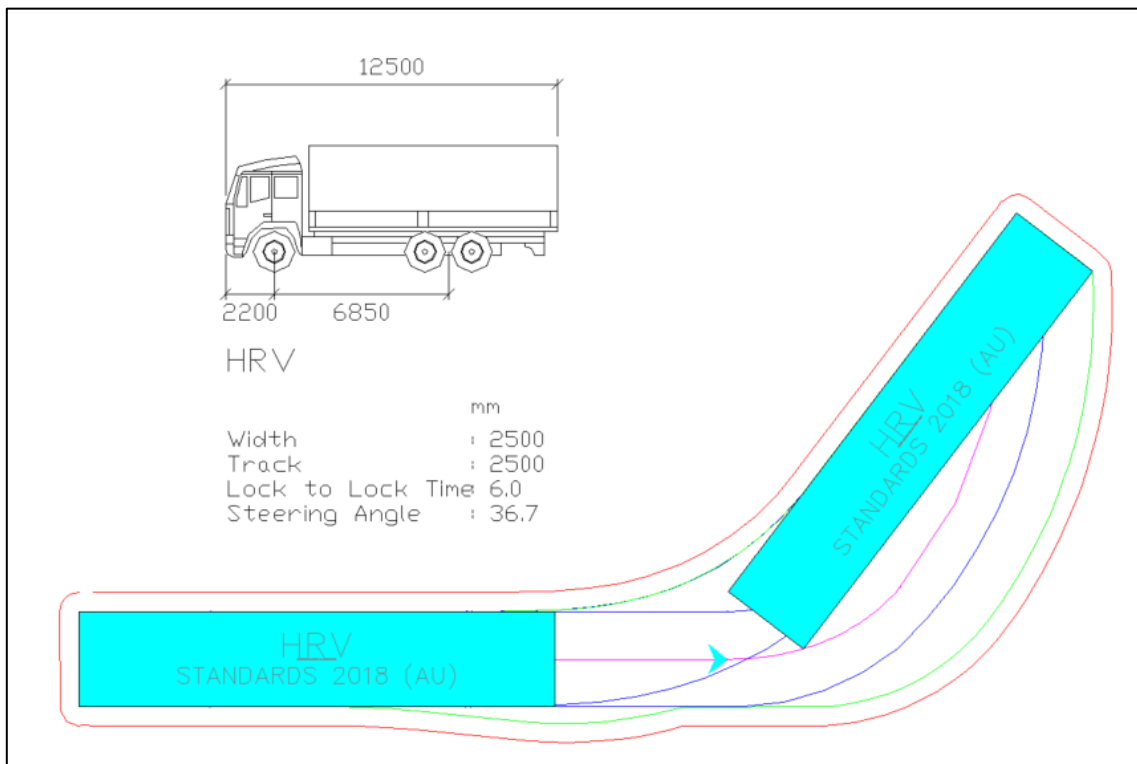

**AUSTRALIAN STANDARD HEAVY RIGID VEHICLE (HRV)**

Blue – Tyre Path  
Green – Vehicle Body  
Red – 500mm Clearance

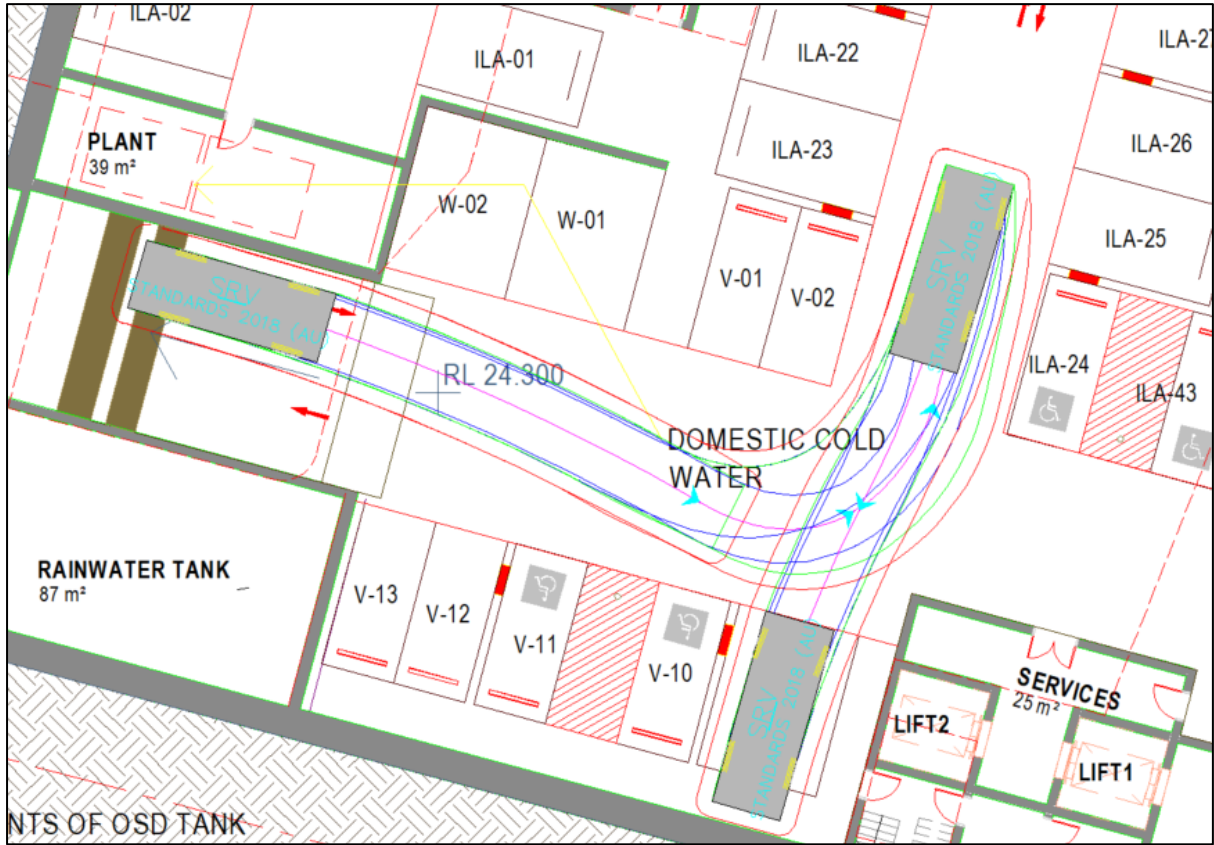

**SRV ENTRY PATH**

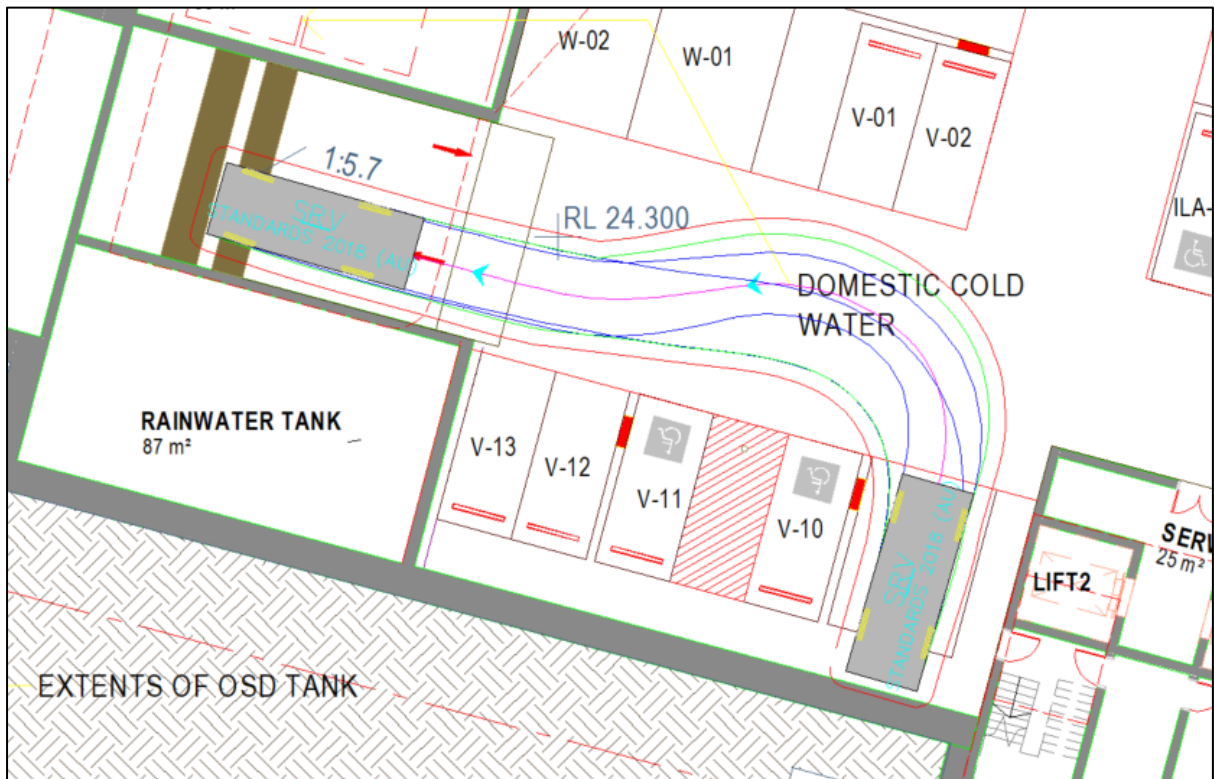

**SRV EXIT PATH**

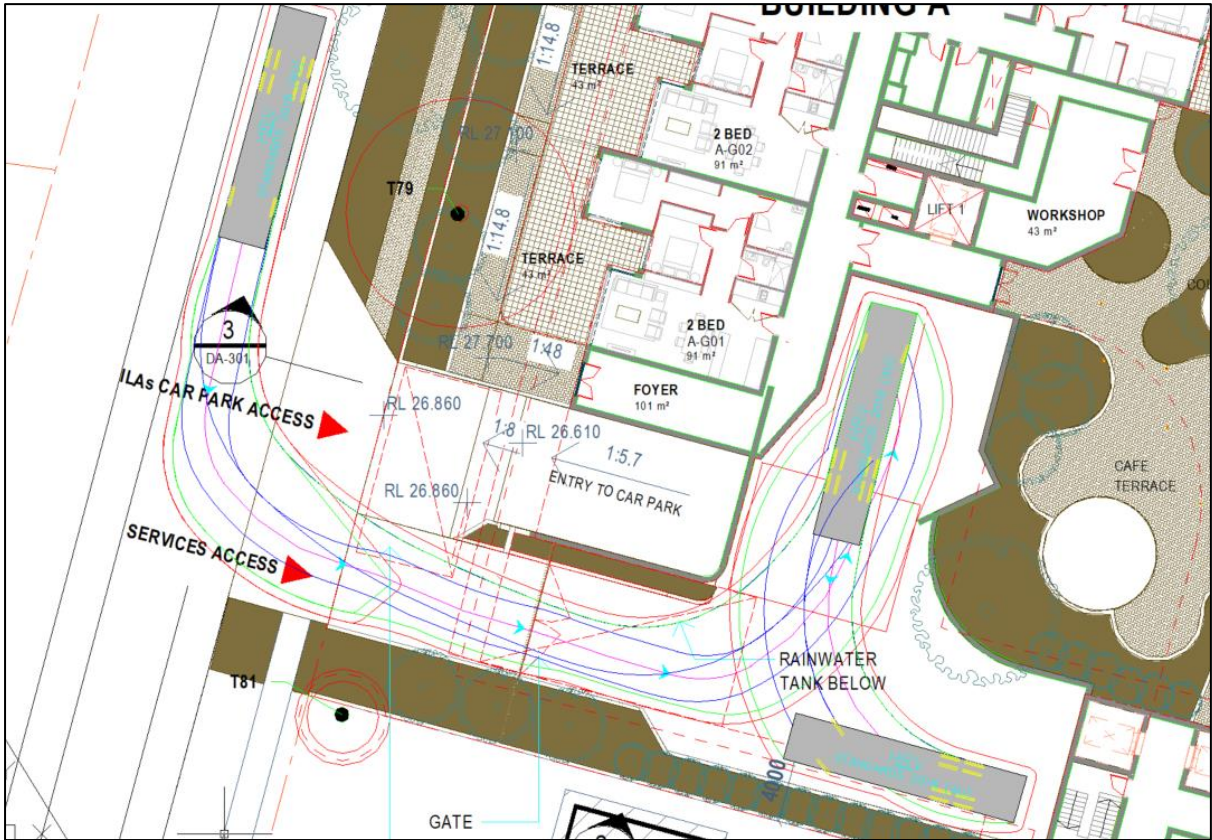

**HRV ENTRY PATH**

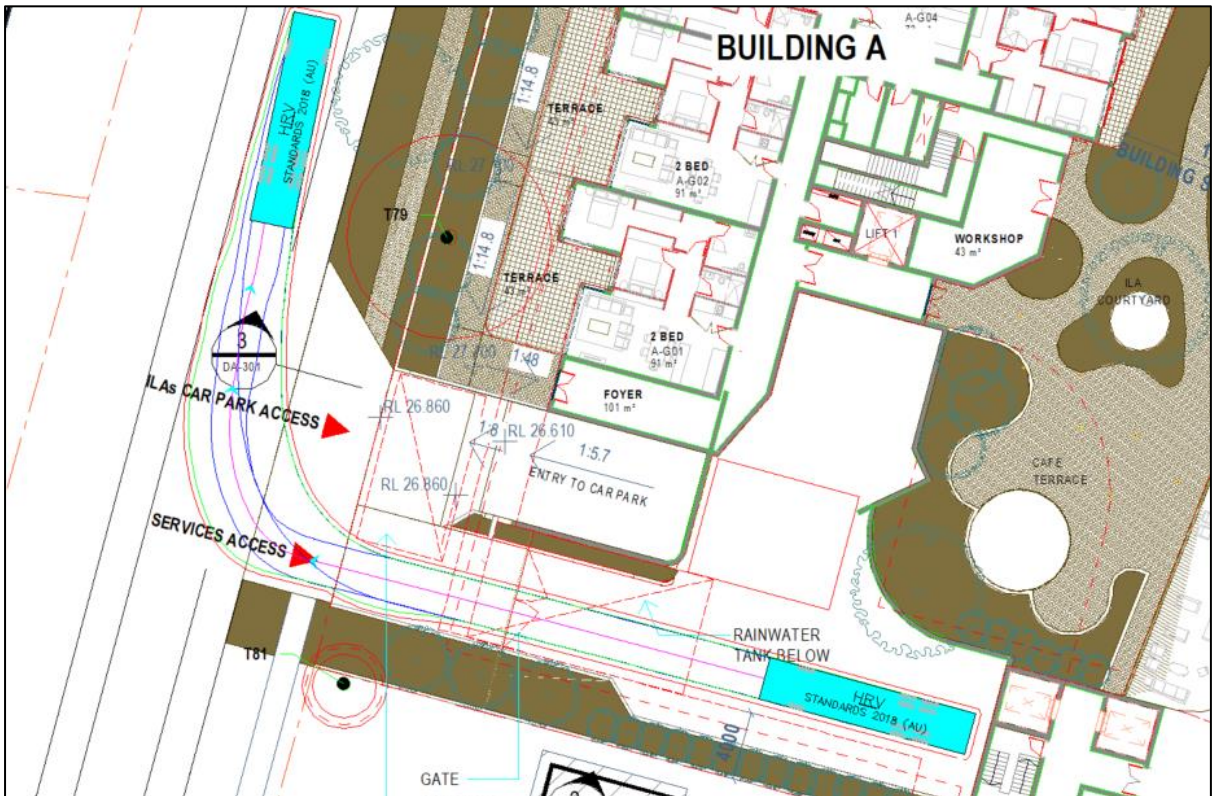

**HRV EXIT PATH**

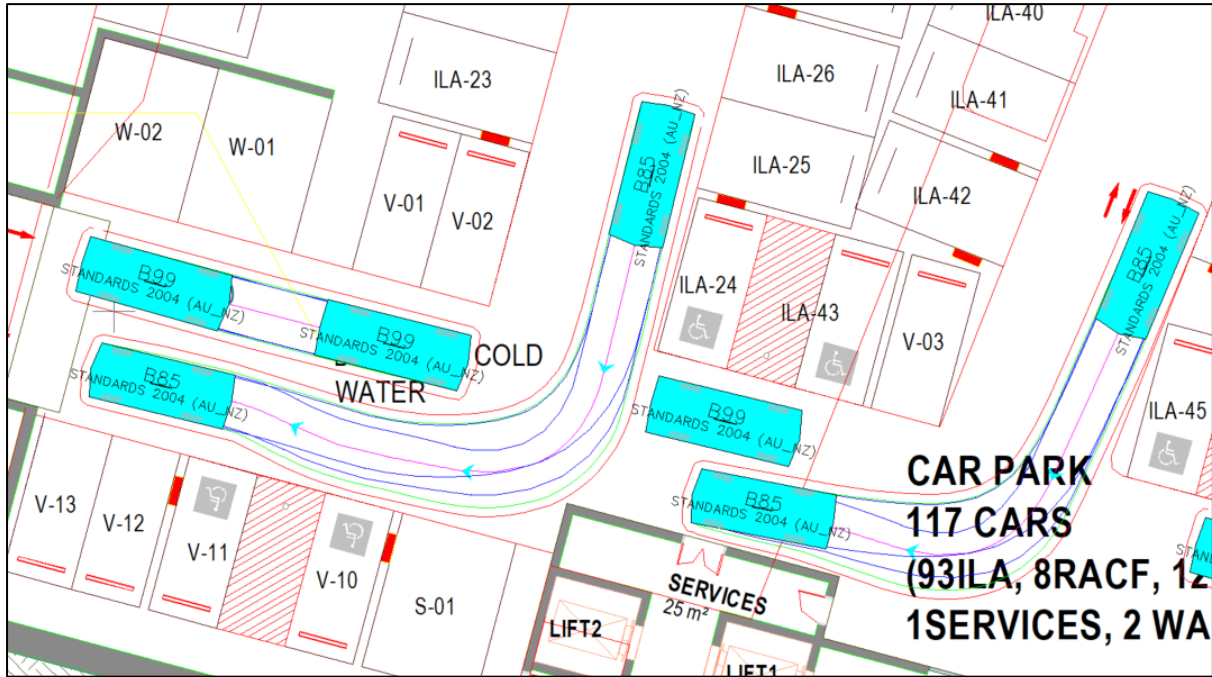

**B99 AND B85 PASSING AT INTERNAL INTERSECTION**

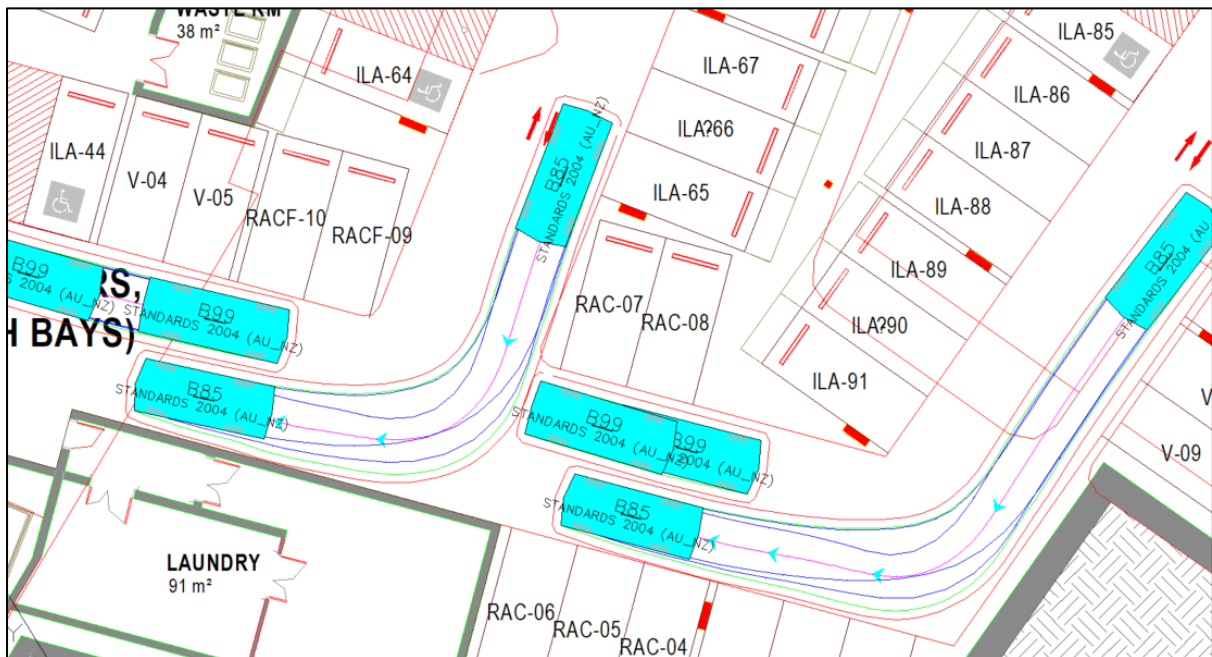

**B99 AND B85 PASSING AT INTERNAL INTERSECTION**

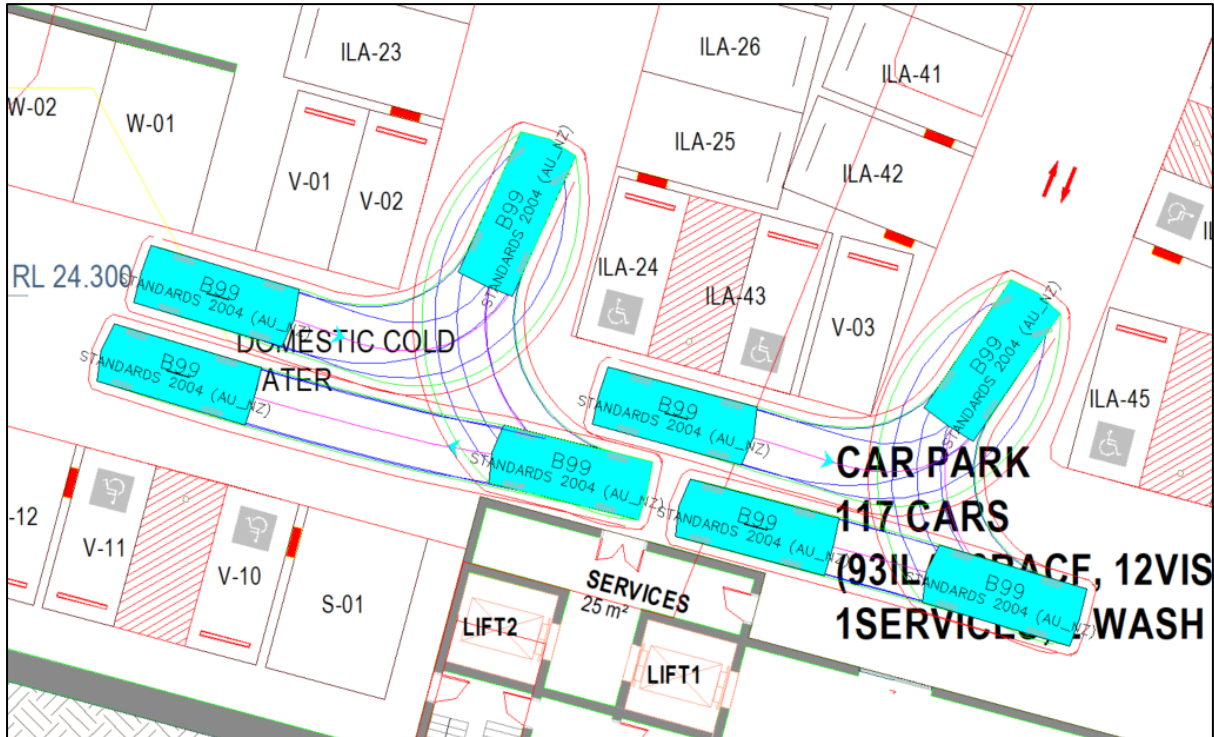

**B99 TURNING AROUND IF VISITOR SPACES ARE FULL**

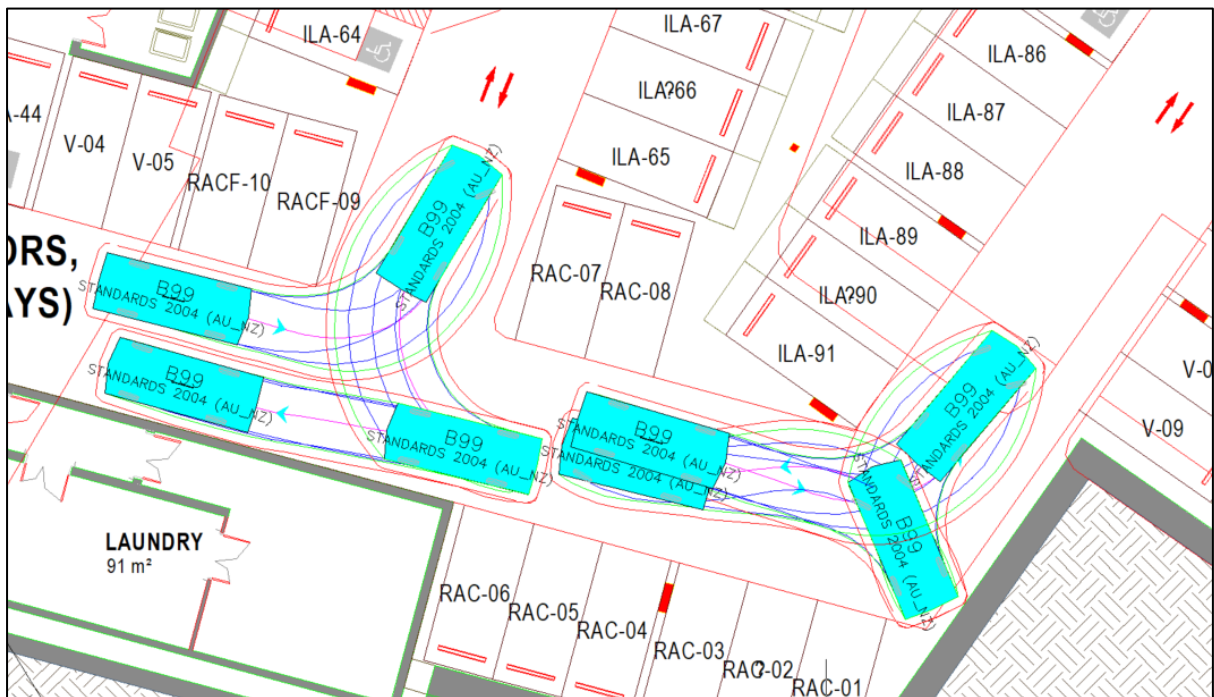

**B99 TURNING AROUND IF VISITOR SPACES ARE FULL**

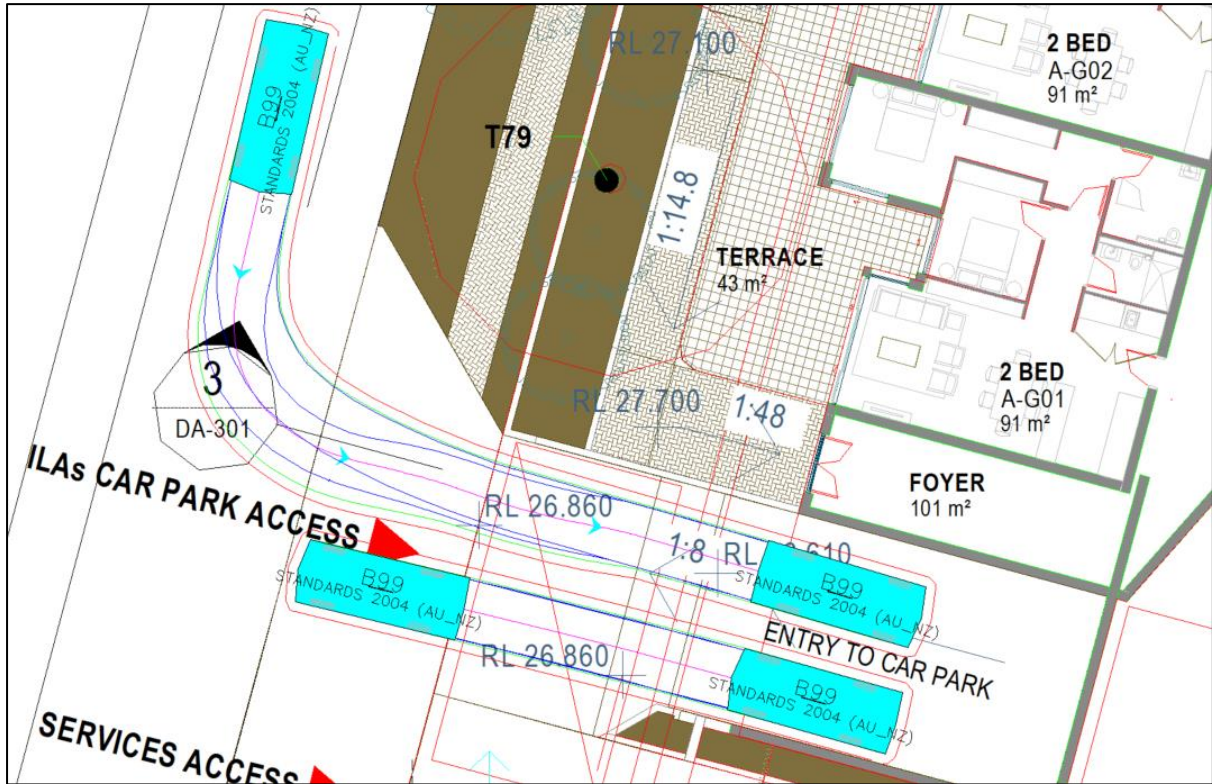

**B85 AND B99 PASSING AT DRIVEWAY**

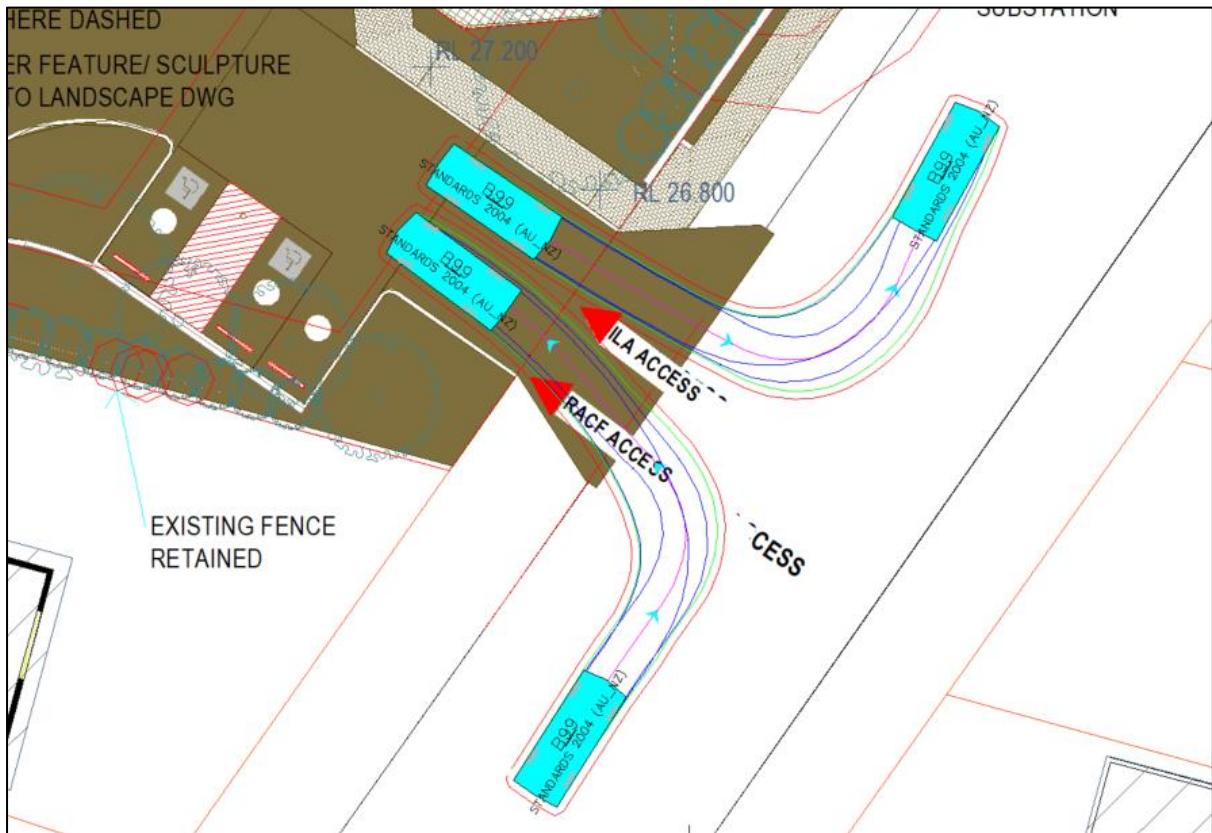

**B85 AND B99 PASSING AT DRIVEWAY**